

## SK BRW5-2-150-450

Part number: 278 281 071

External chassis braking resistor for connection  
to a *NORDAC LINK SK 2xxE-FDS*



Only qualified electricians are allowed to install and commission the module. An electrician is a person who, because of their technical training and experience, has sufficient knowledge with regard to

- switching on, switching off, isolating, earthing and marking power circuits and devices,
- proper maintenance and use of protective devices in accordance with defined safety standards.

### **DANGER!**

#### **Danger of electric shock**

The frequency inverter continues to carry hazardous voltages for up to 5 minutes after it was switched off.

- Work must not be carried out unless the device has been disconnected from the voltage and at least 5 minutes have elapsed since the mains was switched off!

### **CAUTION**

#### **Danger of burns**

The module and all other metal components can heat up to temperatures above 70 °C.

Sufficient cooling time must be allowed for when working on the components in order to avoid injuries (local burns) to parts of the body coming into contact with the components.

In order to avoid damage to neighbouring objects, sufficient clearance must be maintained during installation.

### **NOTICE**

#### **Validity of this document**

This document is only valid in combination with the operating instructions for the relevant frequency inverter. Safe commissioning of this module and the frequency inverter depends on the availability of this information.

Technical Information / Datasheet	SK BRW5-2-150-450			
Brake resistor	TI 278281071	1.0	1918	en

### Scope of delivery

Module		
1 x	<b>Braking resistor</b>	Including cover and connection box
2 x	<b>Terminal 2-pin</b>	WAGO COMPACT Series 221
1 x	<b>Terminal 3-pin</b>	WAGO COMPACT Series 221



### Field of use

Dynamic braking (frequency lowering) of a three-phase motor via a frequency inverter results in generator braking energy that – depending on the application case – is dissipated by a braking resistor. This superfluous energy is transformed into heat.

The braking resistor is intended for Size 2 of the NORDAC LINK SK 250E-FDS ... SK 280E-FDS series and depends on the mains voltage and power.



### Technical Data

#### Electrical data

<b>Number of terminals</b>		3 (WAGO COMPACT)
<b>Resistance</b>	$\Omega$	150

<b>Max. continuous power</b> $P_n$	W	450
<b>Energy consumption</b> $P_{max}^{1)}$	kWs	8.0

<sup>1)</sup> The value given applies to a single use within 120 s.

## General

<b>Temperature range</b>	°C	0 ... 40 (100 % duty cycle/S1) 0 ... 50 (70 % duty cycle/S3)
<b>Tightening torque</b> Cable gland M20	Nm	1.5 – 2.0
<b>Weight</b>	kg	3.3

<b>Certifications</b>	CE, RoHS
<b>Protection class</b>	IP65
<b>Mounting</b> <sup>1)</sup> Screws	4 x M5 x 8 (mounting surface)

<sup>1)</sup> Not included in the scope of delivery

## Dimensions

<b>Envelope dimensions [mm]</b>	W x H x D	405 x 123 x 120
<b>Mounting [mm]</b>	W x D	270 x 100

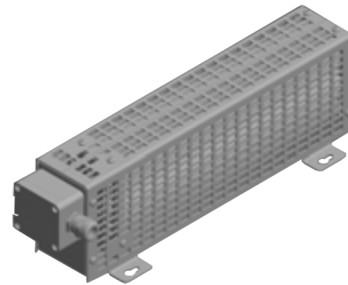
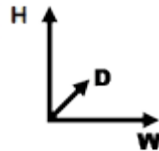

## Connections

**i Information**
**Connection cable (accessory)**

For connection of the external braking resistor to the *NORDAC LINK SK 2xxE-FDS* a **pre-assembled connection cable** is available. The connection is made with an **HANQ2 plug connector** at option slot X2 or X4.





Detailed information can be obtained from the technical data sheet; for further information refer to Section  "Further documentation and software: [www.nord.com](http://www.nord.com)".



Name	PE connection	B+	B-
<b>Cross section / type</b>	AWG 24/12 / WAGO COMPACT, Series 221		
<b>Wire colour</b>	Green    Yellow	White	Grey
<b>Terminal label</b> Terminal box Braking resistor	3-wire connection terminal	2-wire connection terminal	2-wire connection terminal
Contact (socket) option slot X2 / X4	PE	1	2

### Installation

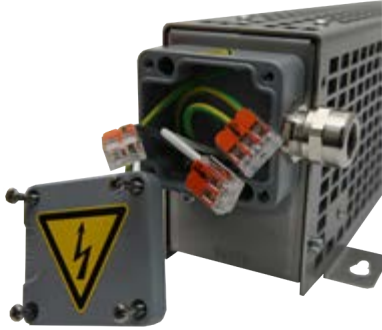
<b>Installation location</b>	Direct wall mounting with optional pre-assembled connection cable for connection to a decentralised frequency inverter as a field distributor: <ul style="list-style-type: none"> <li>In the vicinity of the frequency inverter</li> </ul>
<b>Installation orientation</b>	any
<b>Fastening</b>	With screw fastenings <ul style="list-style-type: none"> <li>Screws for wall mounting are not supplied</li> </ul>

### Installation steps

<p>1. Installing the frequency inverter The size 2 SK 2xxE-FDS frequency inverter is already mounted on the mounting surface.</p>	   
<p>2. Installing the external brake resistor The braking resistor must be mounted directly on the wall or the mounting surface close to the frequency inverter with the 4 fastening screws which must be provided.</p>	
<p>3. Connection cables The braking resistor is connected to the frequency inverter with the pre-assembled connection cable (Part No. 275274881).</p> <ul style="list-style-type: none"> <li>Connect the open end of the connection cable to the terminal box of the braking resistor via the EMC cable gland</li> <li>If necessary, the length (2 m) of the pre-assembled cable can be shortened in advance</li> <li>The connection cable must be properly fastened and connected on both sides</li> <li>First pass the three wires of the connection cable through the                 <ul style="list-style-type: none"> <li>Cable gland</li> <li>Then through the sealing insert</li> <li>The shield clamp</li> <li>The EMC contact spring</li> <li>And the connection thread into the terminal box</li> </ul> </li> <li>Then screw the cable gland to the connection thread</li> <li>The shield of the connection cable must be connected so as to ensure EMC compliance</li> </ul> <p>Make sure the gland is tight and tighten it to the specified torque (see  Technical Data – General).</p>	

4.	<p>The individual wires of the connection cable must be connected to the corresponding WAGO terminals in the terminal box of the braking resistor.</p> <ol style="list-style-type: none"> <li>① green/yellow wire ⇔ PE ⇔ 3-wire terminal</li> <li>② 1st black wire ⇔ B- ⇔ 2-wire terminal with white wire</li> <li>③ 2nd black wire ⇔ B+ ⇔ 2-wire terminal with grey wire</li> </ol>										
5.	<p>The Harting Q2 plug of the connection cable can be connected to option slot X2 or X4 on the underside of the field distributor.</p> <table border="0" style="width: 100%;"> <tr> <td>PE plug</td> <td></td> <td>green/yellow wire</td> </tr> <tr> <td>Connector 1</td> <td>B-</td> <td>First black wire</td> </tr> <tr> <td>Connector 2</td> <td>B+</td> <td>2nd black wire</td> </tr> </table> <p>The contacts are locked by the engagement of the longitudinal clamp from the attachment housing.</p>	PE plug		green/yellow wire	Connector 1	B-	First black wire	Connector 2	B+	2nd black wire	
PE plug		green/yellow wire									
Connector 1	B-	First black wire									
Connector 2	B+	2nd black wire									

### Parameters

Frequency inverter: The following parameters of the frequency inverter have to be set for optimum brake resistor operation. Refer to the frequency inverter manual for details  "Further documentation and software: [www.nord.com](http://www.nord.com)".





Parameters	Meaning	Remarks
P556	Braking resistor	Value of the brake resistance for the calculation of the maximum brake power to protect the resistor. <ul style="list-style-type: none"> <li>The error I<sup>2</sup>t limit (E003.1) is triggered. Further details  in P737.</li> </ul>
P557	Braking resistor type	Continuous power (nominal power) of the resistor, to display the actual utilisation in P737. For a correctly calculated value, the correct value must be entered into P556 and P557. <ul style="list-style-type: none"> <li>0.00 = Off, monitoring disabled</li> </ul>
P737	Usage rate brake res.	This parameter provides information about the actual degree of modulation of the brake chopper or the current utilisation of the braking resistor in generator mode. <ul style="list-style-type: none"> <li>Depending on the settings of parameters P556 and P557.</li> <li>The resistance power is displayed if both parameters are set correctly.</li> </ul>

### Error messages

Error messages from the braking resistor - the current or archived message for the last fault - can be read out from the information parameter Current Fault P700 and the Last Fault P701 in the error memory of the frequency inverter. Refer to the frequency inverter manual for details  "Further documentation and software: [www.nord.com](http://www.nord.com)").

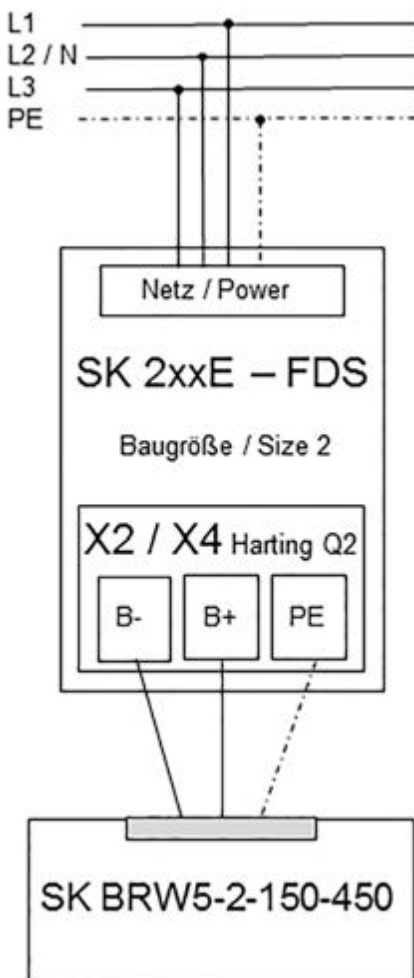
Error (E030/E050)	Meaning	Remarks
3.1	I <sup>2</sup> t overcurrent limit	Brake chopper: I <sup>2</sup> t limit has been triggered, 1.5-fold value for 60 s reached (  P556, P557) <ul style="list-style-type: none"> <li>Avoid overcurrent in brake resistance</li> </ul>
5.0	Oversvoltage UZW	Link circuit voltage too high <ul style="list-style-type: none"> <li>Check the function of the connected braking resistor (broken cable)</li> <li>Resistance value of connected braking resistor too high</li> </ul>

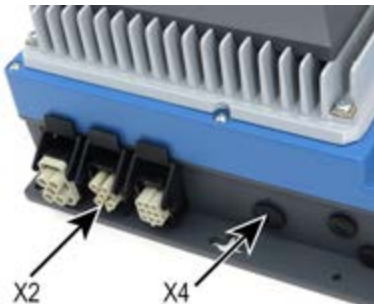
**Wiring diagram**

 <p style="text-align: center;"><b>SK 2xxE – FDS</b> Baugröße / Size 2</p> <p style="text-align: center;"><b>X2 / X4 Harting Q2</b></p> <p style="text-align: center;">B-    B+    PE</p> <p style="text-align: center;"><b>SK BRW5-2-150-450</b></p>	 <p style="text-align: center;"><b>External braking resistor</b> <b>SK BRW5-2-150-450</b></p>
 <p style="text-align: center;">Size 2</p> <p style="text-align: center;"><b>SK 2xxE-FDS</b> <b>Underside of field distributor</b></p>	 <p style="text-align: center;">Accessories</p> <p style="text-align: center;"><b>SK CE-HANQ2-K-BRE-OE-2_0M</b> <b>Connection cables</b></p>

Further documentation and software: [www.nord.com](http://www.nord.com)

Document	Name
<a href="#">BU_0250</a>	Manual for frequency inverters SK 250E-FDS – SK 280E-FDS as field distributors

Part No.	Name	Option / Component
<a href="#">TI_275274881</a>	SK CE-HANQ2-K-BRE-OE-2_0M	Connection cable for connecting the braking resistor to the SK 2xxE-FDS