

INTELLIGENT DRIVESYSTEMS, WORLDWIDE SERVICES

EtherCAT®

EtherNet/IP™

ETHERNET
POWERLINK

PROFI®
NET



BU 0620 – en

Industrial Ethernet

Supplementary manual for series SK 500P



Table of Contents

1	Introduction	8
1.1	General	8
1.1.1	Documentation	8
1.1.2	Document History	8
1.1.3	Copyright notice.....	8
1.1.4	Publisher	8
1.1.5	About this manual.....	9
1.2	Other applicable documents	9
1.3	Presentation conventions.....	9
1.3.1	Warning information	9
1.3.2	Other information.....	9
1.3.3	Text markings	10
1.3.4	Abbreviations.....	11
2	Basics.....	13
2.1	NORD system bus	14
2.1.1	Description.....	14
2.1.2	NORD system bus participants.....	15
2.1.3	Remote maintenance	16
2.2	EtherCat basics.....	17
2.2.1	Characteristics.....	17
2.2.2	Topology.....	17
2.2.3	Bus protocol.....	18
2.2.4	Hot-Connect function.....	18
2.2.5	NMT status machine.....	18
2.2.6	Transfer of process data.....	19
2.2.6.1	Process data telegrams	19
2.2.7	Parameter data transmission.....	20
2.2.7.1	EtherCAT parameters (CoE directory)	20
2.2.7.2	SDO error codes	21
2.3	EtherNet/IP basics	22
2.3.1	Features	22
2.3.2	Topology.....	23
2.3.3	Bus protocol.....	24
2.3.4	Transfer of process data.....	25
2.3.4.1	Assembly Object	25
2.3.5	Parameter data transmission.....	26
2.4	POWERLINK basics	28
2.4.1	Characteristics.....	28
2.4.2	Topology.....	29
2.4.3	Bus protocol.....	30
2.4.3.1	Prescribed POWERLINK address range	32
2.4.4	NMT status machine.....	33
2.4.5	Transfer of process data.....	34
2.4.6	Parameter data transmission.....	36
2.4.7	SDO error codes.....	38
2.5	PROFINET IO basics	39
2.5.1	Characteristics.....	39
2.5.2	Topology.....	40
2.5.3	Bus protocol.....	41
2.5.4	Structure of reference data	46
2.5.5	Transfer of process data.....	48
2.5.5.1	Process data telegrams	49
2.5.6	Parameter data transmission.....	51
2.5.6.1	Structure of acyclic parameter data exchange (Records)	52
2.5.6.2	Data records for acyclic parameter orders	53
2.5.6.3	Data record format	54
2.5.6.4	Examples of data record transfer	58
3	Initial setup	61
3.1	Commissioning of the NORD system bus	61
3.2	Connecting the field bus.....	63

3.3	Setting the field bus protocol.....	64
3.4	Installing the device description file.....	64
3.5	Setting up the EtherNet/IP	65
3.5.1	Automatic device detection.....	65
3.5.2	EtherNet/IP field bus address.....	65
3.6	Setting up EtherCAT	67
3.6.1	Automatic device detection.....	67
3.6.2	EtherCAT field bus address.....	68
3.7	Setting up POWERLINK	69
3.7.1	Automatic device detection.....	69
3.7.2	Initialisation of parameters.....	69
3.7.3	POWERLINK field bus address.....	70
3.8	Setting up PROFINET IO.....	71
3.8.1	Addressing the frequency inverter.....	71
3.8.2	Specify the data format for process data.....	73
3.9	Example: Commissioning the field bus communication	73
4	Parameters.....	75
4.1	NORD standard parameters	76
4.2	Field bus-specific standard parameters	77
4.2.1	EtherCAT standard parameters.....	77
4.2.2	EtherNet/IP standard parameters.....	78
4.2.3	POWERLINK standard parameters.....	80
4.2.4	PROFINET IO standard parameters.....	82
4.3	NORD information parameters.....	84
4.4	Field bus-specific information parameters.....	86
4.4.1	EtherNet/IP information parameters.....	86
4.4.2	POWERLINK information parameters.....	87
4.4.3	PROFINET IO information parameters.....	88
4.5	Frequency inverter parameter settings.....	90
5	Error monitoring and error messages.....	92
5.1	Bus operation monitoring function.....	92
5.2	Resetting error messages.....	93
5.3	Error messages – general communication errors	94
5.4	Troubleshooting – Industrial Ethernet	95
5.4.1	POWERLINK.....	95
5.4.1.1	Error monitoring via the frequency inverter.....	95
5.4.1.2	Error monitoring via POWERLINK.....	95
5.4.2	PROFINET IO.....	98
5.5	LEDs.....	99
5.5.1	Device-specific LEDs.....	100
5.5.1.1	"DEV" LED.....	100
5.5.1.2	"BUS" LED.....	100
5.5.2	Industrial Ethernet status LEDs.....	101
5.5.2.1	EtherCAT.....	101
5.5.2.2	Ethernet/IP.....	102
5.5.2.3	POWERLINK.....	103
5.5.2.4	PROFINET IO.....	104
6	Additional information.....	105
6.1	Data transmission	105
6.1.1	Introduction.....	105
6.1.1.1	Process data.....	105
6.1.1.2	Parameter data.....	105
6.1.2	Transfer of process data.....	106
6.1.2.1	Control word.....	106
6.1.2.2	Status word.....	107
6.1.2.3	Frequency inverter status machine.....	108
6.1.2.4	Setpoints and actual values.....	112
6.1.3	Example of setpoint specification	114
6.2	Topology overview	115
6.2.1	Linear topology.....	115
6.2.2	Star topology.....	116
6.2.3	Ring topology.....	117
6.2.4	Tree topology.....	118

7	Appendix.....	119
	7.1 Service notes	119
	7.2 Documents and software	120

List of illustrations

Figure 1: Example of the structure of a NORD system bus	14
Figure 2: Remote maintenance via Internet (schematic diagram)	16
Figure 3: EtherCAT telegram.....	18
Figure 4: NMT status machine.....	19
Figure 5: EtherNet/IP adaptation to the OSI layer model.....	22
Figure 6: Ethernet telegram (minimum frame length 64 Byte)	24
Figure 7: POWERLINK adaptation to the OSI layer model.....	28
Figure 8: Ethernet telegram (minimum frame length 64 Byte)	30
Figure 9: POWERLINK transfer cycle.....	31
Figure 10: NMT status machine.....	33
Figure 11: PROFINET IO communication via Application Relation AR	40
Figure 12: PROFINET IO telegram (communication within a sub-net)	41
Figure 13: PROFINET IO data cycle times	43
Figure 14: Structure of the application data area – Telegram traffic	46
Figure 15: Example – PROFINET IO device model.....	48
Figure 16: Sequence of acyclic PROFINET IO parameter data exchange	52
Figure 17: Example of monitoring parameter settings	93
Figure 18: LEDs – status displays on the device.....	99
Figure 19: Frequency inverter status machine.....	108
Figure 20: Linear topology (example)	115
Figure 21: Star topology (example)	116
Figure 22: Ring topology (example).....	117
Figure 23: Tree topology (example).....	118

1 Introduction

1.1 General

1.1.1 Documentation

Designation:	BU 0620
Part number:	6076202
Series:	Bus communication with NORDAC PRO, SK 550P <ul style="list-style-type: none"> • EtherCAT® • Ethernet/IP® • POWERLINK • PROFINET® IO

1.1.2 Document History

Edition	Order number	Software version	Remarks
BU 0620 , May 2019	6076202 / 1819	V 1.0 R0	• First issue
BU 0620 , March 2020	6076202 / 1020	V 1.1 R1	• Error correction

1.1.3 Copyright notice

As an integral component of the device or the function described here, this document must be provided to all users in a suitable form.

Any editing or amendment or other utilisation of the document is prohibited.

1.1.4 Publisher

Getriebebau NORD GmbH & Co. KG

Getriebebau-Nord-Straße 1
22941 Bargteheide, Germany

<http://www.nord.com/>

Tel.: +49 (0) 45 32 / 289-0

Fax: +49 (0) 45 32 / 289-2253

1.1.5 About this manual

This manual is intended to assist you with the integration of a NORDAC PRO, SK 550P from Getriebbau NORD GmbH & Co. KG into a field bus system. It is intended for qualified electricians who plan, install and set up the field bus system. The information in this manual assumes that the qualified electricians who are entrusted with this work are familiar with the technology of the field bus system and programmable logic controllers (PLC).

The information in this manual only contains information and descriptions for frequency inverters from Getriebbau NORD GmbH & Co. KG. It does not contain any descriptions of the controllers and the necessary software for other manufacturers.

1.2 Other applicable documents

This manual is only valid in combination with the operating instructions for the relevant frequency inverter ([BU 0600](#)). Only these documents contain all of the information that is required for safe integration and commissioning in a field bus system.

The current versions of the relevant documents can be found under www.nord.com.

1.3 Presentation conventions

1.3.1 Warning information

DANGER

Indicates an immediate danger, which may result in death or very serious injury if it is not avoided.

WARNING

Indicates a dangerous situation, which may result in death or very serious injury if it is not avoided.

CAUTION

Indicates a dangerous situation, which may result in minor injuries if it is not avoided.

NOTICE!

Indicates a situation, which may result in damage to the product or the environment if it is not avoided.

1.3.2 Other information

Information

Indicates hints for use and especially important information to ensure reliability of operation.

1.3.3 Text markings

The following markings are used to differentiate between various types of information:



Text

Type of information	Example	Marking
Instructions	1. 2.	Instructions for actions whose sequence must be complied with are numbered sequentially.
Bullet points	•	Bullet points are marked with a dot.
Parameters	P850	Parameters are indicated by the prefix "P", a three-digit number and bold type.
Arrays	[-01]	Elements of arrays are indicated by square brackets.
Factory settings	{ 0.0 }	Factory settings are indicated by curly brackets.
Software descriptions	"Cancel"	Menus, fields, buttons and tabs are indicated by quotation marks and bold type.

Numbers

Type of information	Example	Marking
Binary numbers	100001b	Binary numbers are indicated by the suffix "b"
Hexadecimal numbers	0000h	Hexadecimal numbers are indicated by the suffix "h"

Symbols used

Type of information	Example	Marking
Cross-reference	 Section 2 "Basics"	Internal cross-reference A mouse click on the text calls up the stated point in the document.
	 Supplementary manual	External cross-reference
Hyperlink	http://www.nord.com/	References to external websites are indicated in blue and underlined. A mouse click calls up the website.

1.3.4 Abbreviations

Abbreviations used in this manual

Abbreviation	Meaning
AG	Absolute encoder
AK	Order label/response label
AR	Application Relation
ASnd	Asynchronous Send (asynchronous sending), POWERLINK telegram type which contains SDO or NMT messages
CAN	Controller Area Network
CIP	Common Industrial Protocol, application protocol for EtherNet/IP
CN	Controlled Node, slave on a POWERLINK field bus
CoE	CAN over EtherCAT
CR	Communication Relation
DAP	Device Access Point
DHCP	Dynamic Host Configuration Protocol, communication protocol for managing IP addresses in a network
DIP	Dual In-Line Package (= double row housing), compact switch block
DLR	Device Level Ring, EtherNet/IP option for ring topologies
EMC	Electromagnetic compatibility
FI	Frequency inverter
HMI	Human-Machine Interface – interface between humans and machines
ID	Identifier
IGBT	Insulated-Gate Bipolar Transistor (semiconductor component)
IND	Index
IP	Internet protocol
I/O	Input, Output
IW	Actual value
MN	Managing Node, POWERLINK bus master (PLC, industrial PC) for control of data communication
NMT	Network Management
PDO	Process Data Object
PKE	Parameter label
PKW	Parameter label value
PNU	Parameter number
PPO	Parameter/Process Data Object
PReq	Poll Request, call-up of cyclic data from CN
PRes	Poll Response, transmission of cyclic data from CN
PWE	Parameter value
PZD	Process data
Rx	Receive

Abbreviation	Meaning
SDO	Service Data Object
SoA	Start of Asynchronous, indicates the start of the asynchronous phase
SoC	Start of Cycle, start of a new transmission cycle
PLC	Programmable Logical Controller
CTW	Control word
SW	Setpoint
TCP	Transmission Control Protocol
Tx	Transmit
UCMM	Unconnected Message Manager, function of an EtherNet/IP- bus participant for the transmission and reception of Explicit Messages
UDP	User Datagram Protocol
USS	Universal serial interface
STW	Status word

2 Basics

The prerequisite for integration of a frequency inverter in a field bus system is an interface which enables communication between them. This interface consists of hardware components (including elements for the electrical connection to a field bus system and a communication processor) and firmware which allows the frequency inverter to communicate with the field bus protocol.

The NORDAC *PRO*, SK 550P frequency inverter is equipped with a bus interface for connection of the following Ethernet-based field bus systems:

- EtherCAT
- EtherNet/IP
- POWERLINK
- PROFINET IO

The supported field bus protocol is set with a parameter.

In addition, there is the option of connecting several NORD frequency inverters via the NORD system bus and therefore indirectly integrating these into a higher-level field bus system.

2.1 NORD system bus

2.1.1 Description

Communication between the various devices from Getriebebau NORD GmbH & Co. KG (frequency inverters and optional modules) and other accessories (absolute encoders) is carried out via a separate NORD system bus. The NORD system bus is a CAN field bus; communication is via the CANopen protocol.

If a frequency inverter with a field bus interface (SK 550P) is connected to further devices via the system bus, these can also be indirectly integrated into the field bus communication without a separate field bus interface. Several frequency inverters can be accessed via an SK 550P.

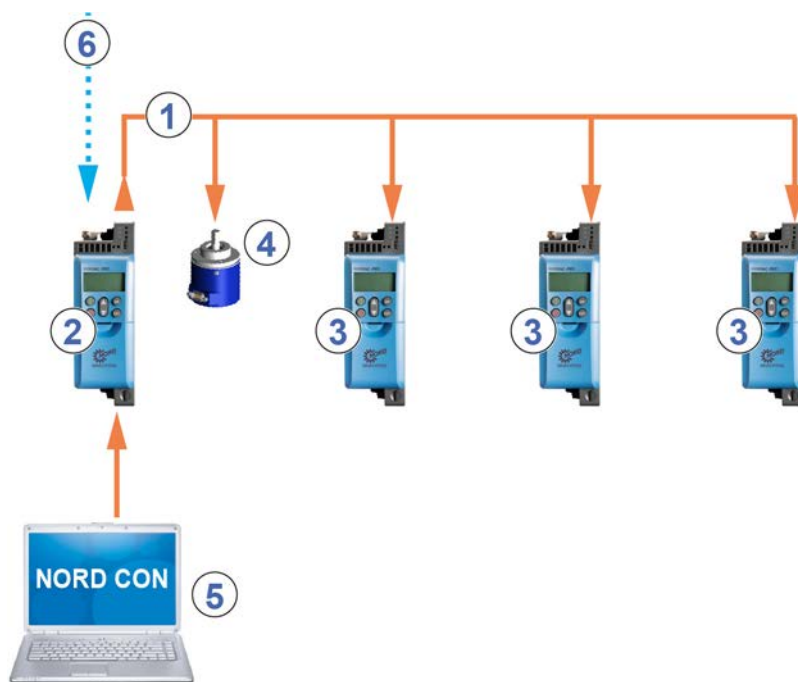

Figure 1: Example of the structure of a NORD system bus

Item	Description
1	NORD system bus (CAN field bus)
2	SK 550P frequency inverter with field bus interface
3	Frequency inverter SK 5x0P
4	Absolute encoder
5	NORDCON computer (on Windows® based PC, on which the NORDCON parameterisation and control software is installed)
6	Field bus

2.1.2 NORD system bus participants

Up to 8 frequency inverters with the associated absolute encoders can be integrated into the NORD system bus. All participants on the NORD system bus must be assigned a unique address (CAN ID). The addresses of the frequency inverters are set with parameter **P515 CAN Address**.

The addresses of connected absolute encoders are set via DIP switches. Absolute encoders must be assigned directly to a frequency inverter. This is carried out using the following equation:

$$\text{Absolute encoder address} = \text{CAN ID of the frequency inverter} + 1$$

This results in the following matrix:

Device	FI 1 (SP 550P)	AG 1	FI 2	AG 2	...
CAN ID	32	33	34	35	...

The termination resistor must be activated on the first and last participant in the system bus ( Frequency inverter manual) The bus speed of the frequency inverter must be set to "250 kBaud" (**P514 CAN Baud Rate**) This also applies to any absolute encoders which are connected.

2.1.3 Remote maintenance

The frequency inverter and all devices from Getriebebau NORD GmbH & Co. KG can also be accessed via LAN or Internet for maintenance purposes.

i Information

Remote maintenance is not possible if EtherCAT is used.

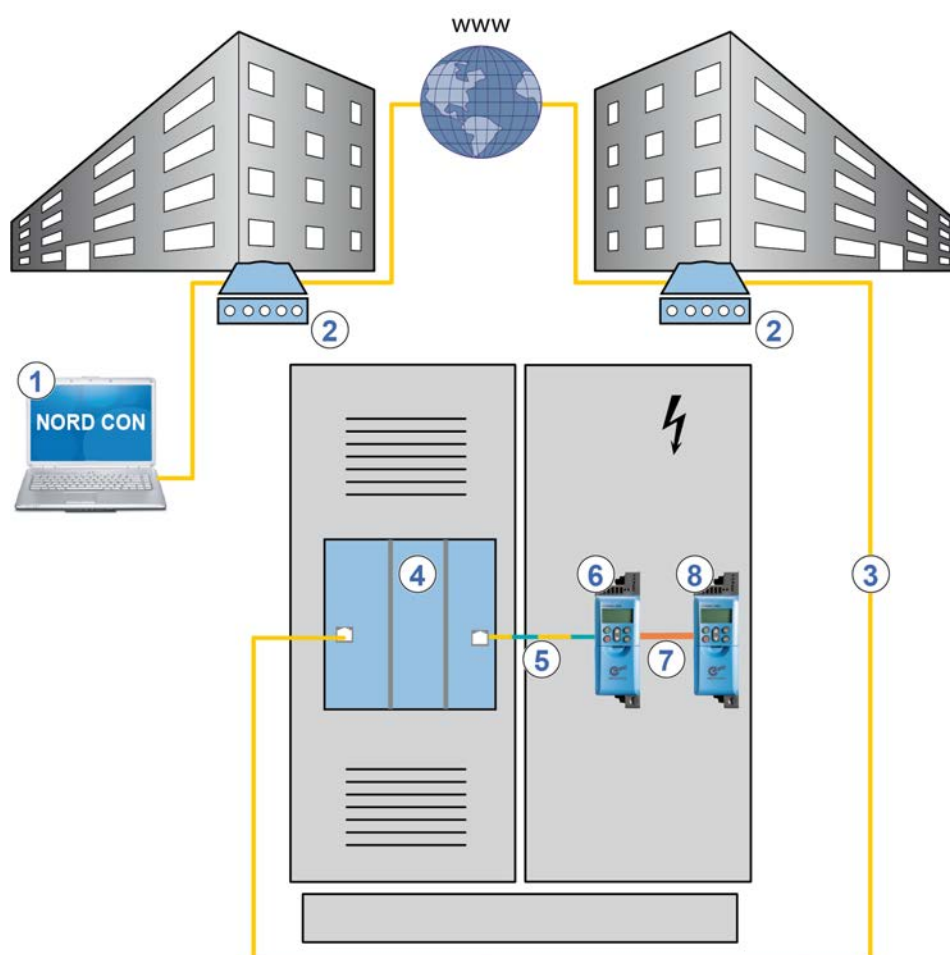

Figure 2: Remote maintenance via Internet (schematic diagram)

Item	Description
1	NORDCON software
2	Modem
3	LAN
4	Field bus gateway or bus master (PLC)
5	Field bus
6	Frequency inverter SK 550P
7	NORD system bus
8	NORD frequency inverter SK 5x0P

2.2 EtherCat basics

2.2.1 Characteristics

EtherCAT (**E**thernet **C**ontrol **A**utomation **T**echnology) is a real time Ethernet. It uses standard frames and the physical layers from the Ethernet standard IEEE 802.3 EtherCAT is published in the standard IEC 61158.

Each bus participant only takes the data which are intended for it while the telegram which is sent by the bus master passes through it. Output data is inserted into the telegram in the same way. At the same time, the telegram is forwarded with a slight delay (a few nanoseconds). The bus participant recognises the commands which are intended for it and executes these. The last bus participant returns the completely processed telegram, so that it can be sent to the controller by the first bus participant as a response telegram.

Addressing of the EtherCAT bus participant is not necessary; this is carried out automatically by the bus master (PLC) according to the physical connection sequence on the bus.

Performance description

Standards	IEC 61158. IEC 61784, ISO 15745, SEMI E54.20
Possible number of bus participants	65,535
Transfer rate	100 MBit (Fast Ethernet, Full Duplex)
Update time	1000 FI axes (each with 8 Byte input and output data) in 1 ms
Wiring	Standard Ethernet cable CAT5 or better
Cable length	Max. 100 m between two nodes

2.2.2 Topology

The following topologies are supported:

- Linear topology
- Star topology
- Tree topology

2.2.3 Bus protocol

EtherCAT application data are embedded in the standard Ethernet frames. For the transfer of process data, an EtherCAT frame is identified with the label "0x88A4" in the type field "Ethertype".

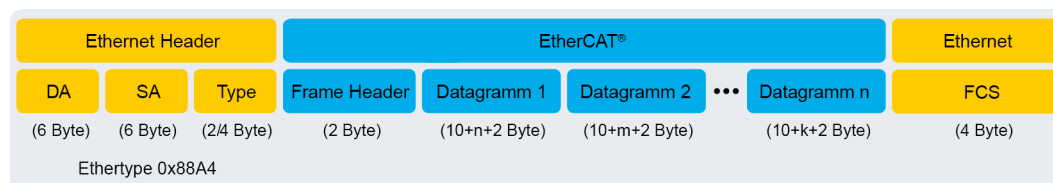

Figure 3: EtherCAT telegram

	Designation	Description
Ethernet Header	DA	Destination Address = Destination address of the EtherCAT frame
	SA	Source Address = source address of the EtherCAT frame
	Type	Type of EtherCAT frame (Ethertype 0x88AB)
Frame Header	—	Information about the length of datagrams within the EtherCAT frame and type of the datagram
Ethernet	FCS	Checksum for the EtherCAT frame

The EtherCAT telegram may consist of several datagrams (EtherCAT commands). The datagram specifies which access the bus master may carry out in the bus system (read, write, read and write, access to one or more bus participants). Each datagram addresses a certain range of the up to 4 Gigabyte logical process image. When the bus system is started up, each bus participant is allocated one or more unique addresses. Several bus participants with an address in the same range can therefore be accessed with a single datagram.

See  Section 2.2.7 "Parameter data transmission" for detailed information.

2.2.4 Hot-Connect function

In EtherCat, "Hot Connect" refers to the removal or addition of bus participants while the bus is in operation. This can be done by switching the bus participant off or on, or by disconnection or connection to parts of the network.

Normally, the EtherCAT master assigns the addresses to the bus participants according to their physical sequence on the field bus. Without the Hot Connect function, the controller would have to re-adapt the bus configuration each time that a bus participant is switched in or out.

Bus participants which are configured for the Hot Connect function must be uniquely identifiable. Because of this, bus participants can be removed or added individually or as a Hot Connect group at any time, without the need for modifying the PLC project. Several configuration levels of the EtherCAT field bus system can therefore be operated with a single PLC project.

The configuration is done by setting an address ("Second Address") via DIP switches ( Section 4.2.1 "EtherCAT standard parameters"), which is read in when the bus interface is switched on.

2.2.5 NMT status machine

When the bus system is started up, the bus interface runs through the EtherCAT NMT status machine. The switch-over between the individual states is made via the bus master (PLC).

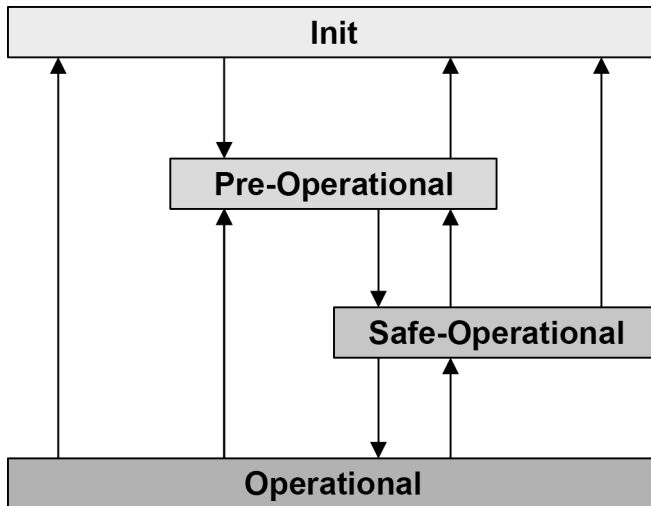

Figure 4: NMT status machine

2.2.6 Transfer of process data

The control word (STW) and up to 3 setpoints (SW) are transferred from the bus master to the frequency inverter and the status word (ZSW) and up to 3 actual values (IW) are transferred from the frequency inverter to the bus master as process data (PZD).

The structure of EtherCAT process data is fixed and is determined by the device description file (📖 Section 3.4 "Installing the device description file").

2.2.6.1 Process data telegrams

The process data telegram for a frequency inverter contains 12 bytes of frequency inverter data:

Direction of transmission	Transmitted data					
	1st word	2nd word	3rd word	4th word	5th word	6th word
	12 Byte					
To the frequency inverter	Control word	Setpoint 1	Setpoint 2	Setpoint 3	Setpoint 4	Setpoint 5
From the frequency inverter	Status word	Actual value 1	Actual value 2	Actual value 3	Actual value 4	Actual value 5

2.2.7 Parameter data transmission

In the "CAN over EtherCAT" protocol (CoE) transfer of parameter data is only carried out via a single SDO channel. The following are transferred:

- Parameter data of the frequency inverter as well as up to 7 frequency inverters connected via the system bus,
- Parameter data which is queried by the bus master from a frequency inverter (FI).

As the NORD parameter numbers of the frequency inverter (0 to 999) are within a number range of the EtherCAT field bus system which is already occupied, Getriebebau NORD GmbH & Co. has defined the following parameter number range:

	FI 1	FI 2	FI 3	FI 4	FI 5	FI 6	FI 7	FI 8
Start Offset	2000h							
Device Offset	0	800h	1000h	1800h	2000h	2800h	3000h	3800h
Numerical range	2000h-27FFh	2800h-2FFFh	3000h-37FFh	3800h-3FFFh	4000h-47FFh	4800h-4FFFh	5000h-57FFh	5800h-5FFFh

NORD parameter numbers must be converted according to the following formula:

Start offset + Device offset + NORD parameter number = EtherCAT parameter number

- **Example for parameter no. 102** ($P102 \rightarrow 102_{\text{dec}} = 66\text{h}$),
Frequency inverter FI 3 $2000\text{h} + 1000\text{h} + 66\text{h} = 3066\text{h}$

Information

For parameters with a sub-index, the first value is always on sub-index "1". Sub-index "0" contains the maximum size of the array.

2.2.7.1 EtherCAT parameters (CoE directory)

Index	Sub-index	Object name	Description	Read/Write	Type (value)
1000h	0	Device type	Device type and functionality	RO	U32
1008h	0	Device name	Device name	RO	STR
1009h	0	Hardware version	Hardware configuration level	RO	STR
100Ah	0	Software Version	Software version	RO	STR
1018h	REC	Identity object	General device information	—	U32
	0	Largest sub-index	Number of elements (=4)	RO	U8
	1	Vendor ID	Manufacturer code (Getriebebau Nord: 00000538h)	RO	U32
	2	Product code	Device version (product number)	RO	U32
	3	Revision number	Software version and revision number (2 x 16 Bit)	RO	U32
	4	Serial number	Not supported	RO	U32
1600h...1607h*	0	Largest sub-index	Number of elements	RO	U8
1600h...1607h*	0-4	RxPDO Mapping	Setpoints for FI 1 to FI 8	RO	U32
1A00h...1A07h*	0	Largest sub-index	Number of elements	RO	U8
1A00h...1A07h*	0-4	TxPDO Mapping	Actual values for FI 1 to FI 8	RO	U32

Index	Sub-index	Object name	Description	Read/Write	Type (value)
1C00h	0-4	Sync.Manager Com. Type	Shows the assignment and use of Sync channels	RO	U8
1C10h	0	Sync.Manager Channel 0	Mailbox received	RO	UCHAR
1C11h	0	Sync.Manager Channel 1	Send mailbox	RO	UCHAR
1C12h	5	Sync.Manager Process Data Output	Process data output	RO	U16
1C13h	5	Sync.Manager Process Data Input	Process data input	RO	U16

* xx00 = FI 1, xx01 = FI 2, ..., xx07 = FI 8

2.2.7.2 SDO error codes

If an SDO transmission fails, a corresponding error code is produced:

Error code	Description
05030000h	Toggle bit unchanged
05040000h	Timeout SDO message (timeout for the SDO response of the bus interface)
05040001h	SDO command invalid/unknown
05040005h	No memory (Insufficient memory)
06010000h	Illegal access to an object
06010001h	Reading access to write-only parameter
06020002h	Writing access to read-only object
06020000h	Object does not exist in the object dictionary (access to a non-existent parameter)
06040043h	Parameter incompatibility
06060047h	Internal incompatibility in the bus interface
06060000h	Access failed due to hardware error
06070012h	Incorrect data type, parameter too long
06070013h	Incorrect data type, parameter too short
06090011h	Sub-Index of parameter does not exist
06090030h	Parameter value range overflow
06090031h	Parameter value too large
06090032h	Parameter value too small
06090036h	Maximum value smaller than the minimum value
08000000h	General error
08000020h	Data transfer or saving not possible, as there is no communication between the bus interface and the frequency inverter

2.3 EtherNet/IP basics

2.3.1 Features

EtherNet/IP (Ethernet Industrial Protocol) is an open communication protocol for industrial automation systems, which uses the basic technology of Ethernet TCP/IP and the CIP (Common Industrial Protocol) application protocol. EtherNet/IP based on the OSI model (Open Systems Interconnection Model = Reference model for network protocols as layer architecture), whereby the EtherNet/IP adaptation to the CIP technology is made in the three upper layers (5...7) and the CIP adaptation to the EtherNet/IP technology is made in the four lower layers (1...4).

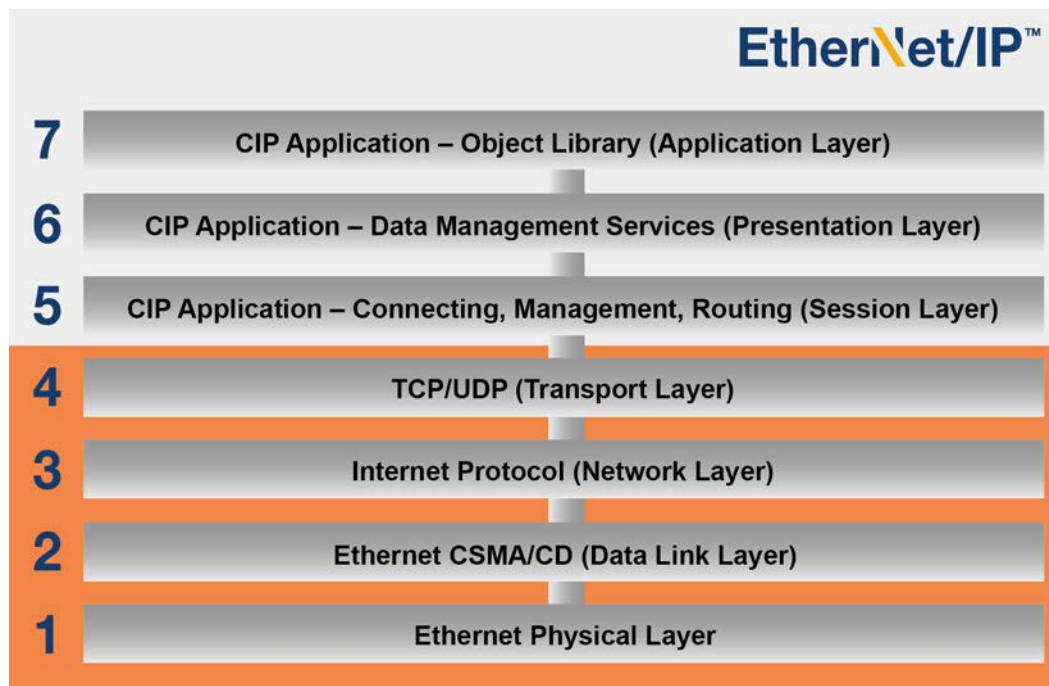

Figure 5: EtherNet/IP adaptation to the OSI layer model

Layer	OSI description	EtherNet/IP adaptation
1	Physical layer, defines the hardware, coding, speed etc. of data transfer	Technology according to standard IEEE 802.3: Definition of the physical media, framework format for data communication, CSMA/CD (Carrier Sense Multiple Access/Collision Detection data communication rules = Multiple access with carrier checks and collision detection).
2	Link layer, defines the communication physics (access method in the field bus and data backup).	Technology according to standard IEEE 802.3: Access procedure according to CSMA/CD which regulates the behaviour of devices in the field bus system.
3...4	The allocation layer (Network) takes over the routing of the data packages to the next bus participant, the transport layer (Transport) allocates the data packages to an application.	TCP/IP (Transmission Control Protocol/Internet Protocol) and TCP/UDP (Transmission Control Protocol/User Datagram Protocol)
5...7	CIP application layers (object oriented), define the interface to the application program with the application-orientated commands.	

EtherNet/IP is managed by the association of users and manufacturers, ODVA (Open DeviceNet Vendors Association).

EtherNet/IP® and CIP® are registered trademarks of the ODVA.

EtherNet/IP is an object oriented field bus system according to CIP, which operates with the Producer/Consumer method. In contrast to conventional transmission/reception methods, in which messages are addressed to particular recipients, with the Consumer/Producer method the field bus participants determine whether they are to process a message on the basis of the Connection ID which is contained in the data telegram.

EtherNet/IP devices can be integrated into an EtherNet/IP field bus system without configuration, however they must be provided with a unique IP address.

Performance description

Possible number of bus participants	255
Transfer rate	100 MBit (Switched Ethernet, Full Duplex)
Supported functions	UCMM, DLR
Supported connection types	<ul style="list-style-type: none"> • Explicit Messaging Connection (parameter data) • I/O Connection (process data): 1 Exclusive Owner, 2 Listen Only
Wiring	Standard Ethernet cable CAT 5 or better
Cable length	Max. 100 m between 2 devices

2.3.2 Topology

The following topologies are supported:

- Linear topology
- Star topology
- Ring topology (No external switch required for bus participants with DLR option (Device Level Ring)).

2.3.3 Bus protocol

The data which are to be communicated via the EtherNet/IP field bus are embedded in standard Ethernet frames.

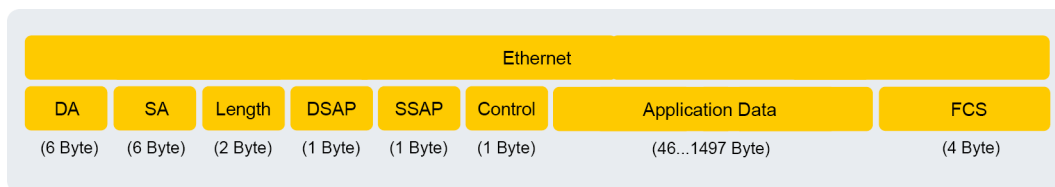

Figure 6: Ethernet telegram (minimum frame length 64 Byte)

Designation	Description
DA	Destination Address = Destination address of the Ethernet frame
SA	Source Address = source address of the Ethernet frame
Length	Information about the length of the application data
DSAP	Destination Service Access Point
SSAP	Source Service Access Point
Control	Type of LLC frame (Logical Link Control Frame)
Application Data	Useful load (min. 46 Byte, max. 1497 Byte)
FCS	Checksum for the Ethernet frame

Data communication (Network Layer and Transport Layer)

A connection between the transmitting and receiving bus participants must be established (via Unconnected Message Manager UCMM) for the exchange of application data. A connection which has been established is used to transmit so-called "Explicit Messages" (data which is necessary for configuration, diagnosis and management) or "I/O Messages" (real time I/O data, also known as "Implicit Messages").

CIP protocol (Application Layer)

The CIP application layer defines the exchange of I/O Messages and Implicit Messages. Communication between two field bus participants is carried out according to a connection-oriented communication model via a point-to-point connection. The data exchange is by means of objects, which are entered in the object index of the field bus device.

In the CIP protocol, each field bus participant receives an object library. CIP objects are subdivided into classes, instances and attributes. A class consists of objects which define the system components of a field bus participant. An instance is a particular object within a class. All instances of a class have the same attributes, but individual attribute values.

See  Section 2.3.5 "Parameter data transmission" for detailed information.

2.3.4 Transfer of process data

In the process data area (PZD), control words and setpoints are transferred from the master to the frequency inverter and in return, status words and actual values are sent from the frequency inverter to the master. The structure of the PZD area is always the same in terms of the sequence of its elements (words), however, dependent upon direction of data Master → Slave / Slave → Master, it is labelled differently. Each word has a length of 16 Bit. To communicate 32 Bit values (e.g. position values), 2 words are required (e.g. setpoint 1 and setpoint 2).

Exchange of process data between frequency inverter and the EtherNet/IP bus master is carried out via I/O Connections. After establishment of an "Exclusive Owner" connection, setpoints and actual values can be exchanged. In addition, two "Listen Only" connections are available, via which the current actual values of the frequency inverter can be "tapped".

2.3.4.1 Assembly Object

The process data (without protocol information) are communicated with the aid of the I/O Message Object. Assignment of the relevant setpoints and actual values is performed via the Assembly Object. The following table contains defined configurations (instances).

Instance	Data length	Description	Length
100	96 Byte	8 frequency inverters (for each frequency inverter: CTW + SW1 + SW2 + SW3 + SW4 + SW5)	Variable
101	96 Byte	8 frequency inverters (for each frequency inverter: STW + IW1 + IW2 + IW3 + IW4 + IW5)	Variable

2.3.5 Parameter data transmission

Access to all parameters of the frequency inverters is via Explicit Messages. A point-to-point connection is established according to the Client/Server principle for the transmission.

The connected frequency inverters are accessed via various classes.

EtherNet/IP Class	Accessed device
101	Frequency inverter FI 1
102	Frequency inverter FI 2
103	Frequency inverter FI 3
104	Frequency inverter FI 4
105	Frequency inverter FI 5
106	Frequency inverter FI 6
107	Frequency inverter FI 7
108	Frequency inverter FI 8

Coding of frequency inverter parameters in EtherNet/IP format

Parameter number in EtherNet/IP format	
Class	 previous table
Attribute	Parameter number
Instance	Sub-index

EtherNet/IP- format in parameter numbers	
Parameter number	Attribute
Sub-index	Instance

An instance is created, depending on the structure of the parameter.

The following applies for parameters without arrays which depend on parameter sets (e.g. parameter **P103**):

Parameter set	Bit 1	Bit 0	Instance
1	0	0	0
2	0	1	1
3	1	0	2
4	1	1	3

The following applies for parameters with arrays which do not depend on parameter sets (e.g. parameter **P465**):

Array	...	Bit 3	Bit 2	Bit 1	Bit 0	Instance
[-01]		0	0	0	0	0
[-02]		0	0	0	1	1
[-03]		0	0	1	0	2
[-04]		0	0	1	1	3
[-05]		0	1	0	0	4
...						

The following applies for parameters with arrays which depend on parameter sets (e.g. parameter P400):

array	Parameter set	Array			Parameter set		Instance
		...	Bit 3	Bit 2	Bit 1	Bit 0	
[-01]	1		0	0	0	0	0
[-01]	2		0	0	0	1	1
[-01]	3		0	0	1	0	2
[-01]	4		0	0	1	1	3
[-02]	1		0	1	0	0	4
[-02]	2		0	1	0	1	5
...							

Examples:

Device	Parameters	Array	Parameter set		Class	Attribute	Instance
F11	P103	—	1	→	101	103	0
F14	P103	—	3	→	104	103	2
F13	P465	[-01]	—	→	103	465	0
F13	P465	[-02]	—	→	103	465	1
F12	P400	[-01]	3	→	103	400	2
F12	P400	[-03]	1	→	103	400	12
F12	P400	[-03]	3	→	103	400	14

2.4 POWERLINK basics

2.4.1 Characteristics

POWERLINK is a real time Ethernet for the transfer of real time data with the emphasis on the transfer of process data in automated systems. POWERLINK uses Layers 2 (data transfer) and 7 (application layer) of the OSI model (Open Systems Interconnection Model = reference model for network protocols as layer architecture, ISO 11898). POWERLINK integrates the CANopen profile into Layer 7 of the OSI model.

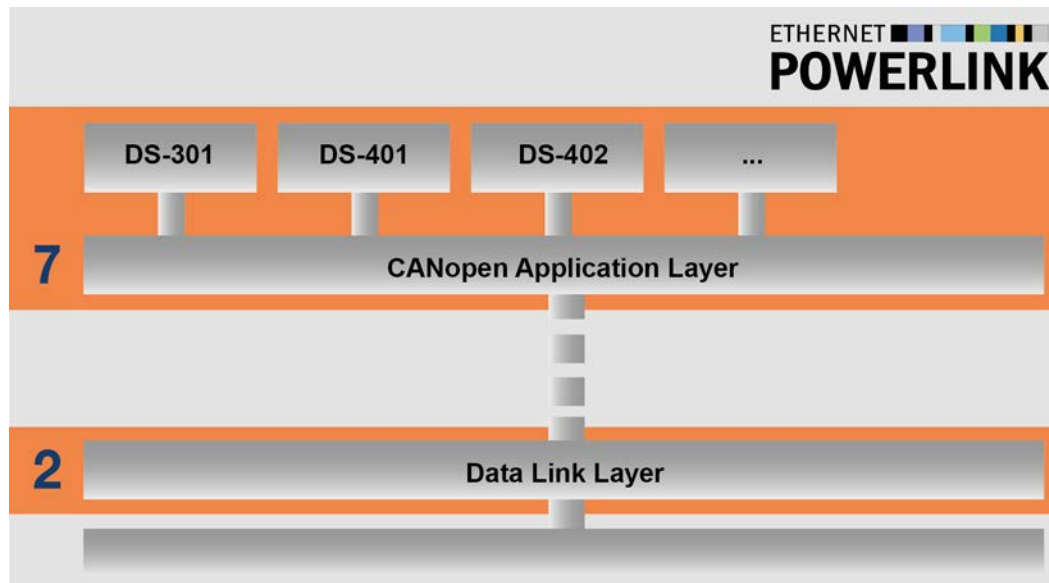

Figure 7: POWERLINK adaptation to the OSI layer model

Item	Description
2 Data Link Layer	Physical layer, defines the hardware, coding, speed etc. of data transfer
7 CANopen Application Layer	CANopen application layer (object oriented), defines the interface to the application program with the application-orientated commands.
DS-301	CANopen communication profile DS-301
DS-401	CANopen device profile DS-401, I/O module
DS-402	CANopen device profile DS-402, drive units

POWERLINK is maintained by the user organisation Ethernet POWERLINK Standardization Group (EPSG) and is published in the standards IEC 61784-2, IEC 61158-3, IEC 61158-4, IEC 61158-5 and IEC 61158-6. POWERLINK complies with Ethernet standard IEEE 802.3 and is available free of charge as a licence-free open source version.

For the cyclic exchange of data via the POWERLINK field bus system, the control system (PLC or industrial PC) becomes a so-called "Managing Node" (MN, leading node = bus master), which determines the cycle time for synchronisation and controls the cyclic exchange of data. The other bus participants are "Controlled Nodes" (CN, = Slaves) The MN sends queries to all CNs in a specified sequence. Each CN sends a response immediately.

Depending on the configuration of the bus master, POWERLINK field devices can be connected to or disconnected from the field bus during network operation without impairing network functions. A restart of the field bus system is not necessary.

Addressing of the POWERLINK bus participants is carried out by:

- the unique MAC address of the device,
- the assigned unique IP address.

Performance description

Standards	IEC 61784-2, IEC 61158-3, IEC 61158-4, IEC 61158-5 and IEC 61158-6
Possible number of bus participants	240
Transfer rate	100 MBit (Switched Ethernet, Full Duplex)
Supported functions	<ul style="list-style-type: none"> • Hot Plugging (CN connection during bus operation) • Isochronous PDO transfer (static mapping) • Asynchronous data transfer (SDO over ASND or UDP/IP)
Wiring	Standard Ethernet cable CAT5 or better
Cable length	Max. 100 m between two bus interfaces

2.4.2 Topology

The following topologies are supported:

- Linear topology
- Star topology
- Tree topology
- Ring topology (only possible if supported by the bus master)

Special POWERLINK hubs or switches are necessary if star or tree structures are used.

2.4.3 Bus protocol

The data which are to be communicated via the POWERLINK field bus are embedded in standard Ethernet frames.

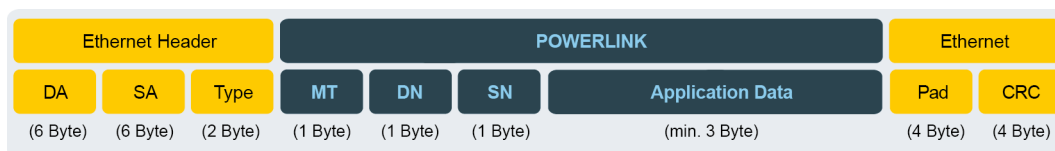

Figure 8: Ethernet telegram (minimum frame length 64 Byte)

Designation	Description
DA	Destination Address = Destination address of the Ethernet frame
SA	Source Address = source address of the Ethernet frame
Type	Type of Ethernet frame (0x88AB)
MT	Message Type = POWERLINK message type
DN	Destination Node
SN	Source Node
Application Data	Useful load (min. 3 Byte, max. 1475 Byte)
Pad	Padding Bytes = Bytes to fill up the Ethernet frame to the required minimum frame length of 64 Byte
CRC	Checksum for the Ethernet frame

POWERLINK uses pre-defined message types

Message Type	ID	Name	Use	Ethernet transfer type
SoC	01h	Start of Cycle	Defines the start of a new transfer cycle	Multicast
PReq	03h	Poll Request	Call up cyclic data from CN	Unicast
PRes	04h	Poll Response	Transmission of current cyclic data from CN	Multicast
SoA	05h	Start of Asynchronous	Indicate the start of the asynchronous phase	Multicast
ASend	06h	Asynchronous Send	Send asynchronous data	Multicast

To ensure deterministic data transfer on the field bus without collisions, POWERLINK data transfer is controlled by the Managing Node (MN, bus master). The Controlled Nodes (CN, Slaves) may only transmit when they are ordered to do so.

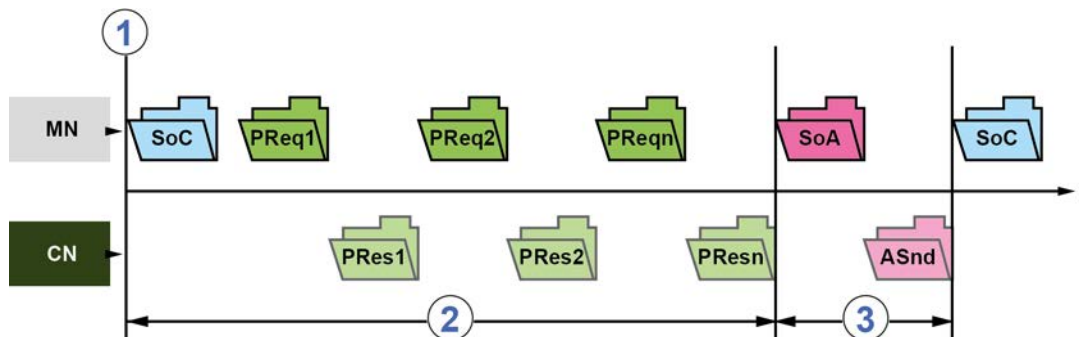

Figure 9: POWERLINK transfer cycle

Item	Description
1	Start of transfer cycle
2	Isochronous phase
3	Asynchronous phase

A transfer cycle starts with the message type "SoC". After this, each CN is queried with a "PReq" by the MN, to which the CN responds with a "PRes". After the end of the transfer cycle, the asynchronous phase starts with the transfer of the "SoA" package. In this phase, a CN which is ordered to do so by the MN transmits acyclic data.

With POWERLINK, all communication and user objects are specified in an object directory (OV) which is based on the CANopen field bus standard, and which serves as a link between the application and the communication device. Each communication object in the object directory is designated with a 16 Bit index. An index may contain up to 256 sub-indices (8 Bit). The assignment to a particular index is defined in the CANopen profiles DS-301 (communication profile) and DS-402 (application profile).

Index range	Use
0000h	Not used
0001h...009Fh	Data types (special case)
00A0h...0FFFh	Reserved
1000h...1FFFh	Communication profile
2000h...5FFFh	Manufacturer-specific objects
6000h...9FFFh	Up to 8 standardised device profiles
A000h...AFFFh	Standardised interface profile
C000h...FFFFh	Reserved

See  Section 2.4.6 "Parameter data transmission" for detailed information.

2.4.3.1 Prescribed POWERLINK address range

When allocating the unique Node ID (fourth byte of the IP address) for the bus interface, the address ranges prescribed by POWERLINK must be strictly complied with.

POWERLINK Node ID		POWERLINK designation	Meaning	Access options
0	C_ADR_INVALID	Invalid	Invalid POWERLINK address	no (none)
1 ... 239	—	POWERLINK Controlled Node	POWERLINK address for field bus slave (CN)	<ul style="list-style-type: none"> • no (none) • mandatory • optional • isochronous • asynchronous only
240	C_ADR_MN_DEF_NODE_ID	POWERLINK Managing Node	POWERLINK address for the bus master (MN)	Mandatory isochronous
241 ... 250	Reserved (EPSG profile DS-302-A [1])			
251	C_ADR_SELF_ADR_NODE_ID	POWERLINK Pseudo Node	POWERLINK address for self-addressing of a bus participant	No (none)
252	C_ADR_DUMMY_NODE_ID	POWERLINK Dummy Node	POWERLINK address as place holder	No (none)
253	C_ADR_DIAG_DEF_NODE_ID	Diagnostic device	POWERLINK standard address for diagnostic devices	<ul style="list-style-type: none"> • optional • isochronous • asynchronous only
254	C_ADR_RT1_DEF_NODE_ID	POWERLINK to legacy Ethernet router	POWERLINK standard address for Type 1 routers (obsolete Ethernet routers)	<ul style="list-style-type: none"> • no (none) • mandatory • optional • isochronous
255	C_ADR_BROADCAST	POWERLINK broadcast	POWERLINK broadcast address	No (none)

2.4.4 NMT status machine

When the bus system is started up, the bus interface runs through the POWERLINK NMT status machine.

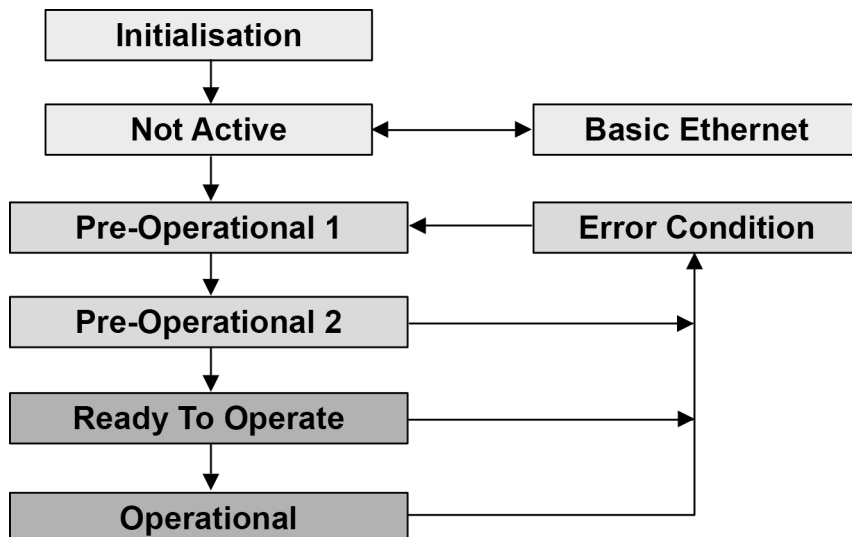

Figure 10: NMT status machine

Status	Description
Initialisation	Initialisation phase: <ul style="list-style-type: none"> No communication of process data and parameters The field bus system is monitored for POWERLINK frames. If no frame is received within the set time (timeout) the bus interface changes to the state "Basic Ethernet". If a POWERLINK frame is detected before the set time has elapsed, the bus interface changes to the state "Pre-Operational".
Pre-Operational 1	Field bus running: <ul style="list-style-type: none"> Parameter communication possible No process data communication The Controlled Node waits for the reception of a SoC-Frame and then changes to the state "Pre-Operational 2". If the red LED "BE" illuminates in this state, the Managing Node has failed.
Pre-Operational 2	<ul style="list-style-type: none"> Parameter communication possible No process data communication In this state, the interface is configured by the Managing Node. After this, a command is given to switch to the state "Ready to operate". If the red LED "BE" illuminates in this state, the Managing Node has failed.
Ready To Operate	Ready for operation <ul style="list-style-type: none"> Parameter communication active Limited communication of process data possible. Configuration of the bus interface by the Managing Node is complete. Normal cyclic and asynchronous communication is possible. The transmitted PDO data complies with the PDO mapping. Cyclic data are not evaluated. If the red LED "BE" illuminates in this state, the Managing Node has failed.
Operational	Normal operation: <ul style="list-style-type: none"> Parameter communication active Process data communication active
Basic Ethernet	Parameter communication only possible via UDP/IP. If communication is detected on the POWERLINK field bus during this state, the bus interface changes to the state "Pre-Operational 1". If the red LED "BE" illuminates, the Managing Node has failed.
Stopped	Output data are not output and input data are not supplied. This state can only be achieved and exited by a corresponding command from the Managing Node.

2.4.5 Transfer of process data

In the process data area (PZD), control words and setpoints are transferred from the master to the frequency inverter and in return, status words and actual values are sent from the frequency inverter to the master. The structure of the PZD area is always the same in terms of the sequence of its elements (words), however, dependent upon direction of data Master → Slave / Slave → Master, it is labelled differently. Each word has a length of 16 Bit. To communicate 32 Bit values (e.g. position values), 2 words are required (e.g. setpoint 1 and setpoint 2).

For POWERLINK the length and structure of the process data are fixed and are determined by the device description file (XDD file). 6 process values are available for each direction of transmission and connected frequency inverter: 1 control word or 1 status word and 5 setpoints or 5 actual values.

PDO mapping

The frequency inverter supports dynamic mapping. In the default mapping, all of the maximum possible 8 frequency inverters are mapped. The process data telegram contains 96 bytes of frequency inverter data:

Transmission direction	Transmitted data (96 Byte)					
	Frequency inverter FI 1					
	1st word	2nd word	3rd word	4th word	5th word	6th word
To the FI (RX)	Control word	Setpoint 1	Setpoint 2	Setpoint 3	Setpoint 4	Setpoint 5
Address	5000.1h	5000.2h	5000.3h	5000.4h	5000.5h	5000.6h
From the FI (TX)	Status word	Actual value 1	Actual value 2	Actual value 3	Actual value 4	Actual value 5
Address	5010.1h	5010.2h	5010.3h	5010.4h	5010.5h	5010.6h
Transmission direction	Frequency inverter FI 2					
	7th word	8th word	9th word	10th word	11th word	12th word
	To the FI (RX)	Control word	Setpoint 1	Setpoint 2	Setpoint 3	Setpoint 4
Address	5001.1h	5001.2h	5001.3h	5001.4h	5001.5h	5001.6h
From the FI (TX)	Status word	Actual value 1	Actual value 2	Actual value 3	Actual value 4	Actual value 5
Address	5011.1h	5011.2h	5011.3h	5011.4h	5011.5h	5011.6h
Transmission direction	Frequency inverter FI 3					
	13th word	14th word	15th word	16th word	17th word	18th word
	To the FI (RX)	Control word	Setpoint 1	Setpoint 2	Setpoint 3	Setpoint 4
Address	5002.1h	5002.2h	5002.3h	5002.4h	5002.5h	5002.6h
From the FI (TX)	Status word	Actual value 1	Actual value 2	Actual value 3	Actual value 4	Actual value 5
Address	5012.1h	5012.2h	5012.3h	5012.4h	5012.5h	5012.6h
Transmission direction	Frequency inverter FI 4					
	19th word	20th word	21st word	22nd word	23rd word	24th word
	To the FI (RX)	Control word	Setpoint 1	Setpoint 2	Setpoint 3	Setpoint 4
Address	5003.1h	5003.2h	5003.3h	5003.4h	5003.5h	5003.6h
From the FI (TX)	Status word	Actual value 1	Actual value 2	Actual value 3	Actual value 4	Actual value 5
Address	5013.1h	5013.2h	5013.3h	5013.4h	5013.5h	5013.6h

Transmission direction	Frequency inverter FI 5					
	25th word	26th word	27th word	28th word	29th word	30th word
To the FI (RX)	Control word	Setpoint 1	Setpoint 2	Setpoint 3	Setpoint 4	Setpoint 5
Address	5004.1h	5004.2h	5004.3h	5004.4h	5004.5h	5004.6h
From the FI (TX)	Status word	Actual value 1	Actual value 2	Actual value 3	Actual value 4	Actual value 5
Address	5014.1h	5014.2h	5014.3h	5014.4h	5014.5h	5014.6h
Transmission direction	Frequency inverter FI 6					
	31st word	32nd word	33rd word	34th word	35th word	36th word
To the FI (RX)	Control word	Setpoint 1	Setpoint 2	Setpoint 3	Setpoint 4	Setpoint 5
Address	5005.1h	5005.2h	5005.3h	5005.4h	5005.5h	5005.6h
From the FI (TX)	Status word	Actual value 1	Actual value 2	Actual value 3	Actual value 4	Actual value 5
Address	5015.1h	5015.2h	5015.3h	5015.4h	5015.5h	5015.6h
Transmission direction	Frequency inverter FI 7					
	37th word	38th word	39th word	40th word	41th word	42nd word
To the FI (RX)	Control word	Setpoint 1	Setpoint 2	Setpoint 3	Setpoint 4	Setpoint 5
Address	5006.1h	5006.2h	5006.3h	5006.4h	5006.5h	5006.6h
From the FI (TX)	Status word	Actual value 1	Actual value 2	Actual value 3	Actual value 4	Actual value 5
Address	5016.1h	5016.2h	5016.3h	5016.4h	5016.5h	5016.6h
Transmission direction	Frequency inverter FI 8					
	43rd word	44th word	45th word	46th word	47th word	48th word
To the FI (RX)	Control word	Setpoint 1	Setpoint 2	Setpoint 3	Setpoint 4	Setpoint 5
Address	5007.1h	5007.2h	5007.3h	5007.4h	5007.5h	5007.6h
From the FI (TX)	Status word	Actual value 1	Actual value 2	Actual value 3	Actual value 4	Actual value 5
Address	5017.1h	5017.2h	5017.3h	5017.4h	5017.5h	5017.6h

2.4.6 Parameter data transmission

Access to all parameters of the frequency inverter is via objects (SDO)

Object address (SDO-ID)		Accessed device
Device ID	Address range	
2000h	2000h...25FFh	Frequency inverter FI 1
2600h	2600h...2BFFh	Frequency inverter FI 2
2C00h	2C00h...31FFh	Frequency inverter FI 3
3200h	3200h...37FFh	Frequency inverter FI 4
3800h	3800h...3DFFh	Frequency inverter FI 5
3E00h	3E00h...43FFh	Frequency inverter FI 6
4400h	4400h...49FFh	Frequency inverter FI 7
4A00h	4A00h...4FFFh	Frequency inverter FI 8

Information

Processing during transmission/querying of SDOs depends on the PLC which is used ( manufacturer's information)

Access to the parameters of the frequency inverter is carried out by creating an index and a sub-Index.

Index

In order to generate an index, the relevant parameter number must be converted into the SDO ID according to the following formula:

Formula	SDO ID = Device ID + Parameter number
Calculation example	Parameter P102, frequency inverter FI 5
	SDO-ID = 3800h + 102 = 3800h + 66h = 3866h

Sub-index

Generation of a sub-index depends on the structure of the relevant parameter:

NORD-specific					POWERLINK-sub-index
Parameter type	Example	Sub-index	Array element	Parameter set	
Simple	P218	0	—	—	00h
Depends on parameter set	P102	Array size			00h
		0	—	P1	01h
		0	—	P2	02h
		0	—	P3	03h
		0	—	P4	04h
Array parameters	P480	Array size			00h
		1	[-01])	—	01h
		2	[-02])	—	02h
		3	[-03])	—	03h
Parameter set dependent array parameter	P525	Array size			00h
		1	[-01])	P1	01h
				P2	02h
				P3	03h
				P4	04h
		2	[-02])	P1	05h
				P2	06h
				P3	07h
P4	08h				

2.4.7 SDO error codes

In case of problems during parameter data communication (e.g. exceeding the value range) an abort telegram is transferred. The error codes correspond to the POWERLINK standard EPSG DS-301.

Error code	Description
05040000h	Timeout SDO message (timeout for the SD response from the bus interface)
05040001h	SDO command invalid/unknown
05040002h	Impermissible size of transferred data
05040003h	Error in sequence layer
05040005h	No memory (Insufficient memory)
06010000h	Illegal access to an object
06010001h	Reading access to write-only parameter
06020002h	Writing access to a read-only parameter
06020000h	Access to a non-existent parameter
06040043h	Parameter incompatibility
06060047h	Internal incompatibility in the bus interface
06060000h	Access failed due to hardware error
06070010h	The data type does not match the length of access
06070012h	Incorrect data type, parameter too long
06070013h	Incorrect data type, parameter too short
06090011h	Sub-Index of parameter does not exist
06090030h	Parameter value range overflow
06090031h	Parameter value too large
06090032h	Parameter value too small
06090036h	Maximum value smaller than the minimum value
08000000h	General error
08000020h	Data transfer or saving not possible, as there is no communication between the bus interface and the frequency inverter
08000021h	Bus interface does not respond

2.5 PROFINET IO basics

2.5.1 Characteristics

PROFINET IO is a protocol for communication with peripherals based on the Ethernet standard IEEE 802.3. PROFINET IO is based on PROFIBUS DP and uses Switched-Ethernet technology as the physical communication medium for the rapid communication of I/O data and parameters. PROFINET IO is specified in the standards IEC 61158 and IEC 61784.

In contrast to the PROFIBUS Master-Slave method, PROFINET IO is a Provider-Consumer model, which supports communication relations (CR) between equal field bus participants. In addition to the cyclic exchange of process data, diagnostic data, parameters and alarms can be communicated via the PROFINET IO field bus system.

PROFIBUS® and PROFINET® are registered trademarks of PROFIBUS and PROFINET International (PI).

PROFINET IO bus participants are classified according to their tasks:

Name	PROFINET IO bus participant	Task
IO Controller	Controller (PLC)	Performs the master function for I/O data communication with bus participants and controls the process. As a provider, the IO controller sends the output data to the IO devices and as a consumer it processes the input data which is sent from the IO devices.
IO Device	Decentralised field bus device	As a provider, the IO device sends the input data to the IO controller and as a consumer it processes the output data which is sent from the IO controller.
IO Supervisor	Programming device, HMI or PC	PROFINET IO tool for parameterisation and diagnosis of IO devices, which is only used temporarily for commissioning and diagnosis.

Addressing of PROFINET IO bus participants is carried out via:

- The unique MAC address of the device,
- The unique assigned device name and
- The unique assigned IP address.

For communication between the IO controller and an IO device a so-called "Application Relation" **AR** is established, with which the "Communication Relations" **CR** are specified.

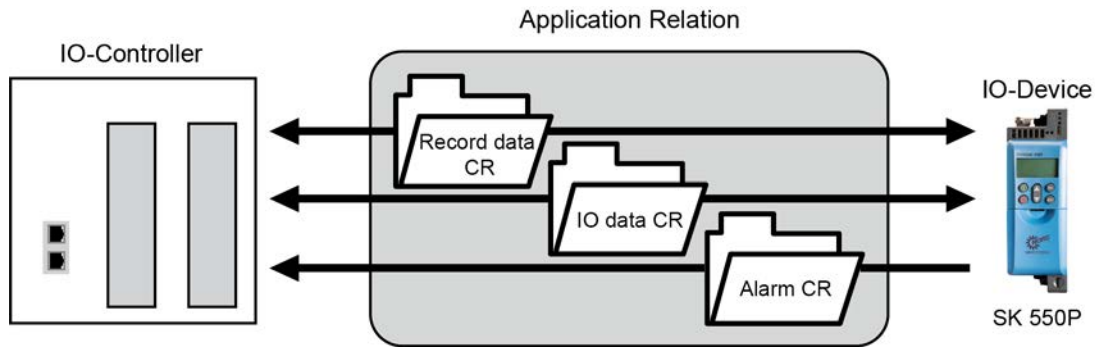

Figure 11: PROFINET IO communication via Application Relation AR

Communication Relation CR	Description
IO data CR	For cyclic communication of process data
Record data CR	For acyclic communication of parameter data
Alarm CR	For alarm messages in real time

Performance description

Standards	IEC 61158, IEC 61784
Possible number of bus participants	Practically unlimited, depending on the number of participants with which the IO controller can communicate.
Transfer rate	100 MBit (Switched Ethernet, Full Duplex)
Update interval	≥ 5 ms (exchange of process data with the frequency inverter)
Conformance Class	B, C
Transmission and reception cable	Auto Crossover, Auto Negotiation, Auto Polarity
Wiring	Standard Ethernet cable CAT 5 or better
Cable length	Max. 100 m between two nodes

2.5.2 Topology

The following topologies are supported:

- Linear topology
- Star topology
- Tree topology
- Ring topology (Media Redundancy Protocol (MRP) required)

2.5.3 Bus protocol

The PROFINET IO process data are embedded in standard Ethernet frames. For communication of process data, a PROFINET IO frame is identified with the label "8892h" and a frame ID in the type field "Ethertype".

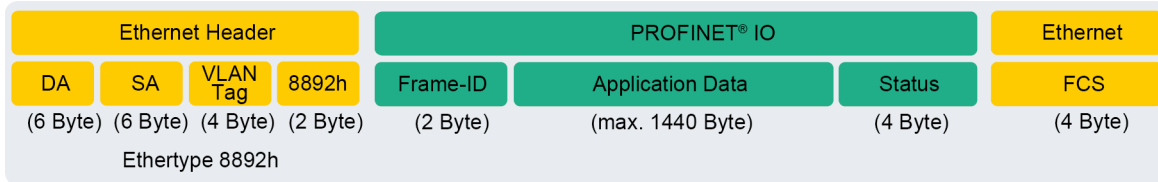

Figure 12: PROFINET IO telegram (communication within a sub-net)

	Designation	Description
Ethernet Header	DA	Destination Address = Destination address of the PROFINET IO frame
	SA	Source Address = Source address of the PROFINET IO frame
	VLAN Tag	Identifier for communicating the priority
	8892h	Ethertype identifier
PROFINET IO	Frame ID	Data identifier for cyclic or acyclic communication
	Status	Status information
Ethernet	FCS	Checksum of the PROFINET IO frame

PROFINET IO is subdivided into various performance classes, the so-called "Conformance Classes" CC-A, CC-B and CC-C.

Conformance Class	Description
CC-A	<ul style="list-style-type: none"> • Cyclic exchange of I/O data with real time characteristics • Acyclic data exchange for reading and writing of parameters and diagnostic data, including the function Identification & Maintenance I&M for reading out device information • Alarm function for signalling device and network faults in three levels (maintenance requirement, urgent maintenance requirement, diagnosis)
CC-B	<ul style="list-style-type: none"> • Cyclic exchange of I/O data with real time characteristics • Acyclic data exchange for reading and writing of parameters and diagnostic data, including the function Identification & Maintenance I&M for reading out device information • Alarm function for signalling device and network faults in three levels (maintenance requirement, urgent maintenance requirement, diagnosis) • Network diagnosis with the Simple Network Management Protocol (SNMP) • Topology detection with the Link Layer Discovery Protocol (LLDP)
CC-C	<ul style="list-style-type: none"> • Cyclic exchange of I/O data with the Isochronous Real Time Protocol • Acyclic data exchange for reading and writing of parameters and diagnostic data, including the function Identification & Maintenance I&M for reading out device information • Alarm function for signalling device and network faults in three levels (maintenance requirement, urgent maintenance requirement, diagnosis) • Network diagnosis with the Simple Network Management Protocol (SNMP) • Topology detection with the Link Layer Discovery Protocol (LLDP) • Reservation of bandwidth: Part of the available communication bandwidth of 100 MBit is exclusively reserved for real time tasks • Synchronisation of the application program clock to the bus cycle

The process data are communicated cyclically from the IO controller to the IO devices in real time and inversely from the IO devices into the process image of the IO controller. As the IO controller transfers the data without a request, when the system is started up, the IO devices are informed that they will receive current data in a particular bus cycle.

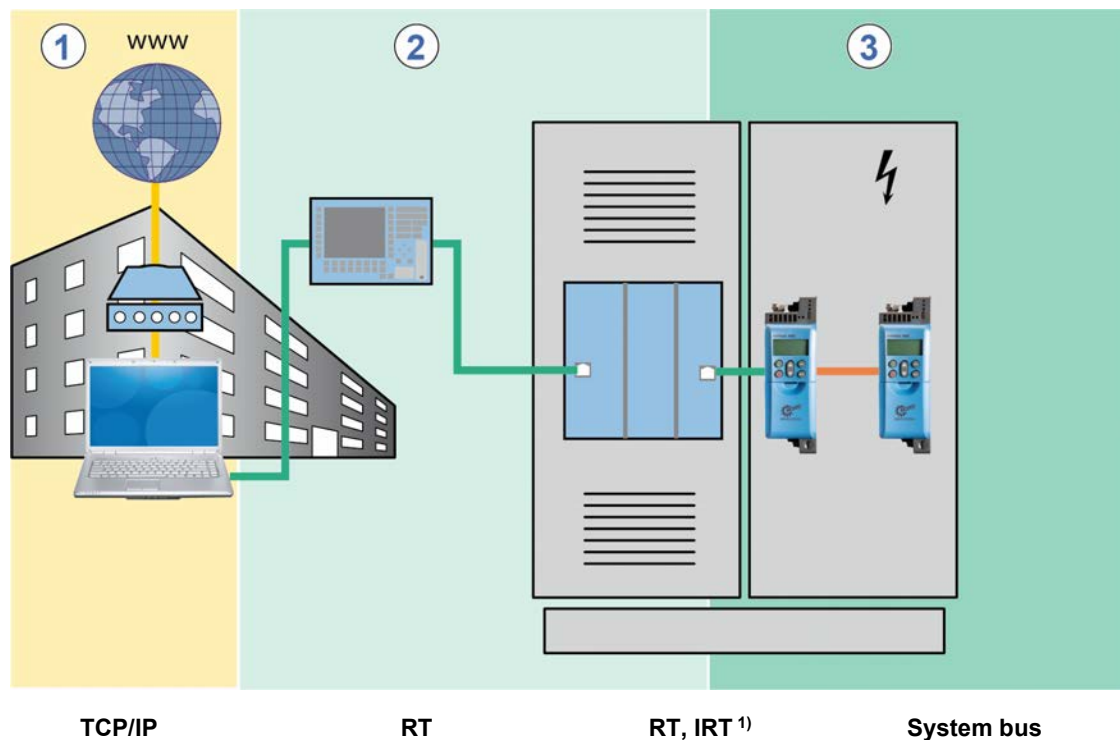

¹⁾ See Information RT, IRT

Figure 13: PROFINET IO data cycle times

Item	Description
1	Standard communication (IT services, TCP/IP)
2	Process automation
3	Motion Control (drive control)
TCP/IP	Internet protocol, cycle time less than 100 ms
RT	Real time protocol, cycle time less than 10 ms
IRT	Isochronous real time protocol, cycle time 0.25 ms...1.0 ms
System bus	NORD-specific bus system between the bus interface and frequency inverters, cycle time ≥ 5 ms

PROFINET IO real time communication is divided into the following classes:

RT class	Description
RT_CLASS_1	Unsynchronised real time communication within a sub-network (identical to network ID) Unsynchronised RT communication is the normal form of PROFINET IO data communication and is implemented in all IO field devices. Industrial standard switches can be used in this RT class. Suitable for typical cycle times of 10 ms.
RT_CLASS_2 (IRT Flex)	RT_CLASS_2 frames can be communicated either synchronised or unsynchronised. With synchronised communication the start of a bus cycle is defined for all participants. This defines precisely when a field device may transmit. This is always the start of the bus cycle (clock synchronisation) for all field devices involved in RT_CLASS_2 communication. Combination with RT_Class_1 is possible.
RT_CLASS_3 (IRT or IRT Top)	Synchronised communication within a sub-net. Transmission of process data takes place in a sequence which is specified by the system engineering. This optimised data communication requires considerable planning effort, special hardware and the use of real time switches. Suitable for cycle times of 0.25 ms...1 ms.
RT_CLASS_UDP	Unsynchronised data exchange of UDP data packages between different sub-nets. Suitable for the communication of PROFINET IO data which are not time-critical. This RT communication (Transport Protocol TCP/UDP-ID) can be implemented with all standard network components (e.g. Internet, company Intranet, etc.) Data cycles of 5 ms with 100 Mbit/s can be achieved in Full Duplex mode.

Details of communication sequence

PROFINET IO works on the basis of real time communication (RT). It is therefore possible to configure the bus system so that in addition to RT communication, isochronous real time communication (IRT) is possible, which is especially important for time-sensitive procedures such as for Motion Control applications. With a corresponding configuration of an IO controller, communication in PROFINET IO operates in two phases, the IRT phase and the open phase.

The IRT phase is exclusively reserved for IRT frames. In the course of planning, the user precisely specifies the sequence in which the participants transmit. Communication between the participants is carried out synchronously. Any accumulating RT frames or UDP/IP frames are temporarily saved in the switches without processing. In this way, the IRT frames can be transferred to the IO controller without waiting times. The resulting telegraph run time for the IRT frames ultimately depends on the number of switches which are integrated into the communication line and their throughput times.

In the open phase, which is defined by the IO controller, the temporarily stored RT or UDP/IP frames are transferred. However, a destination port can only receive one frame at a time from the switch. Further frames which are intended for this destination port are temporarily saved in the switch. Depending on the structure or the setup of the communication line, there may be a delay in the exchange of information during the open phase.

This means that with isochronous real time communication (IRT) the run times for messages between the devices and the IO controller are always identical; in contrast, for real time communication (RT) they depend on the bus load and are therefore different in each cycle. The difference between RT and IRT communication therefore does not lie in the performance of the individual components, but rather in the limitations due to the extension of the communication line.

The SK 550P bus interface has an integrated switch with two ports for setting up a linear topology.

Communication between the NORD drive components is via the NORD system bus. The required communication time is added to the run time for PROFINET IO communication.

The specific values for the update interval for process data, parameter reading and writing access can be obtained from the frequency inverter manual (BU 0600).

2.5.4 Structure of reference data

The cyclic exchange of application data between the IO controller and the frequency inverters is carried out via two areas:

- PKW area = **P**arameter **L**abel **V**alue (parameter level)
- PZD area = **P**rocess**D**ata (process data level)

Parameter values can be read and written via the PKW area. These are essentially configuration, monitoring and diagnostic tasks.

The frequency inverter is controlled via the PZD area. This is done by transfer of the control word, the status word and by setpoint and actual values.

An access always consists of an order and a response telegram. In the order telegram, the application data from the IO controller is transferred to the IO device. In the response telegram, the application data is transferred from the IO device to the IO controller.

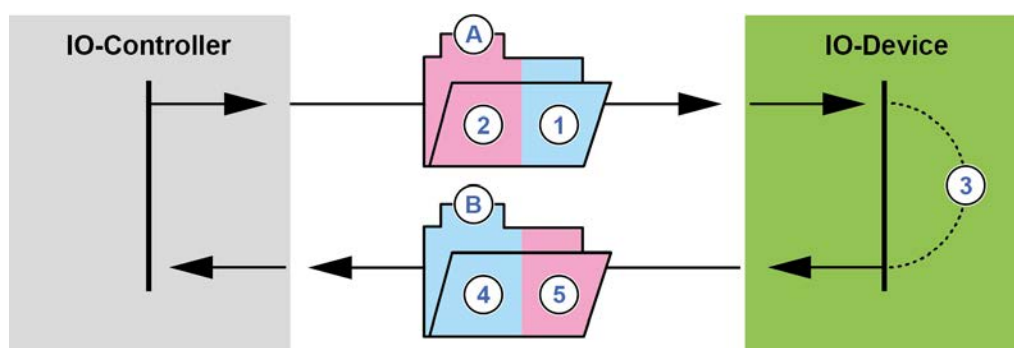

Figure 14: Structure of the application data area – Telegram traffic

Item	Meaning
A	Order telegram
1	Parameter order
2	Control word and setpoints
3	Processing
W	Response telegram
4	Parameter response
5	Status word and actual values

Processing of the process data is carried out in the FI with high priority, in order to ensure a rapid response to control commands or a change in status can be transmitted to the IO controller without delay.

Processing of PKW data is carried out with low priority and can take considerably longer.

The cyclic data traffic is carried out via parameter process data objects (PPO) which are defined in PROFIBUS, with which both process data (PZD) as well as parameters (PKW) are transferred from the IO controller to the IO device. NORD frequency inverters can process PPO types 1, 2, 3, 4 and 6.

Structure of PPO types:

	PKW				PZD					
	PKE	IND	PWE	PWE	PZD1	PZD2	PZD3	PZD4	PZD5	PZD6
					STW	SW1	SW2	SW3	WAF 4	WAF 5
					ZSW	IW1	IW2	IW3	IW4	IW5
1st word	2nd word	3rd word	4th word	5th word	6th word	7th word	8th word			
PPO 1	x	x	x	x	x	x				
PPO 2	x	x	x	x	x	x	x	x		
					1st word	2nd word	3rd word	4th word	5th word	6th word
PPO 3					x	x				
PPO 4					x	x	x	x		
PPO 6					x	x	x	x	x	x

For detailed information see  Section 2.5.5.1 "Process data telegrams".

2.5.5 Transfer of process data

The control word (CTW) and up to 5 setpoints (SW) are transferred from the IO controller to the frequency inverter and the status word (STW) and up to 5 actual values (IW) are transferred from the frequency inverter to the IO controller as process data.

Addressing of the process data is performed with a slot/index combination. The slots and sub-slots of NORD frequency inverters are read by the IO controller from the device description file (📖 Section 3.4 "Installing the device description file").

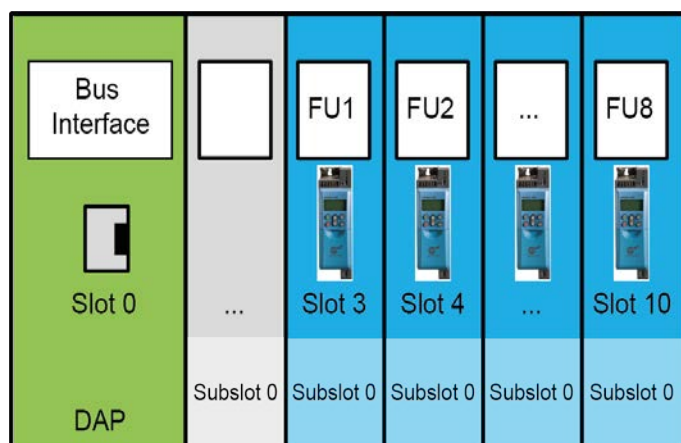

Figure 15: Example – PROFINET IO device model

Designation	Description
DAP	Device Access Point, access point for communication with the Ethernet interface
FI 1	Frequency inverter 1 (SK 550P)
FI 2...FI 8	Frequency inverters 2...8 (SK 5x0P)

The length and structure of the process data are determined by the PPO types which the IO controller reads out from the device description file. The PPO types must be assigned to the slots for the bus participants during the configuration of the IO controller (PLC project). The PPO types are defined in the PROFIBUS profile.

2.5.5.1 Process data telegrams

Getriebbau NORD GmbH & Co. KG uses the PPO types PPO3, PPO4 and PPO6 as process data telegrams for cyclic communication of process data.

PPO3

Transmission direction	Transmitted data (4 Byte)	
	1st word	2nd word
to the frequency inverter	Control word	Setpoint 1
from the frequency inverter	Status word	Actual value 1

PPO4

Transmission direction	Transmitted data (8 Byte)			
	1st word	2nd word	3rd word	4th word
to the frequency inverter	Control word	Setpoint 1	Setpoint 2	Setpoint 3
from the frequency inverter	Status word	Actual value 1	Actual value 2	Actual value 3

PPO6

Transmission direction	Transmitted data (12 Byte)					
	1st word	2nd word	3rd word	4th word	5th word	6th word
to the frequency inverter	Control word	Setpoint 1	Setpoint 2	Setpoint 3	Setpoint 4	Setpoint 5
from the frequency inverter	Status word	Actual value 1	Actual value 2	Actual value 3	Actual value 4	Actual value 5

Getriebbau NORD GmbH & Co. KG uses the PPO types PPO1 and PPO2 for the cyclic exchange of process and parameter data.

PPO1

Transmission direction	Transmitted data (12 Byte)					
	1st word	2nd word	3rd word	4th word	5th word	6th word
to the frequency inverter	AK and PNU	IND	PWE HI	PWE LO	Control word	Setpoint 1
from the frequency inverter	AK and PNU	IND	PWE HI	PWE LO	Status word	Actual value 1

AK Order label

IND Parameter index

PNU Parameter number

PWE Parameter value

([↩](#) Section 2.5.6 "Parameter data transmission")

PPO2

Transmission direction	Transmitted data (16 Byte)							
	1st word	2nd word	3rd word	4th word	5th word	6th word	7th word	8th word
to the frequency inverter	AK and PNU	IND	PWE HI	PWE LO	CTW	Setpoint 1	Setpoint 2	Setpoint 3
from the frequency inverter	AK and PNU	IND	PWE HI	PWE LO	STW	Actual value 1	Actual value 2	Actual value 3

AK Order label

IND Parameter index

PNU Parameter number

PWE Parameter value

([📄](#) Section 2.5.6 "Parameter data transmission")

2.5.6 Parameter data transmission

Transmission of parameter data is carried out acyclically. As with the process data, the parameter data are assigned via slots (📖 Section 2.5.5 "Transfer of process data"). Parameter data for the frequency inverter FI 1 are transferred... (slot assignment ...)

Using the PKW area (📖 Section 2.5.5 "Transfer of process data"), parameter processing can also be carried out in the cyclical data traffic. For this, the IO-Controller formulates an order and the inverter formulates the appropriate response to this. The PKW area is only used for the transfer or PPO types 1 and 2.

In principle, the PKW area consists of

- A **parameter identification**, in which the type of order (Write, Read etc.) and the relevant parameters are specified.
- An **Index (IND)**, with which the individual parameter sets or arrays are addressed,
- The **Parameter value (PWE)**, which contains the value which is to be read or written.

Field ¹		Data size	Explanation
PKE	Parameter label (Order label AK and parameter number PNU)	2 Byte	Parameter of the bus interface or the frequency inverter. The parameter number plus "1000". The order label is attached to the parameter number (upper nibble).
IND	Parameter index	2 Byte	Parameter sub-index
PWE	Parameter value	4 Byte	New setting value

¹ Description of the fields in the following sections.

A parameter order must be repeated until the inverter responds with the corresponding response telegram.

Information

Max. 100,000 permissible writing cycles

If parameter changes are made (order by the IO-Controller via the PKW channel), the maximum number of permissible writing cycles to the frequency inverter EEPROM (100,000 cycles) must not be exceeded. I.e. continuous cyclical writing must be prevented.

For certain applications it is sufficient if the values are only saved in the RAM of the frequency inverter. The corresponding setting can be made by selecting the appropriate AK or via the parameter **P560 Save in EEPROM**.

2.5.6.1 Structure of acyclic parameter data exchange (Records)

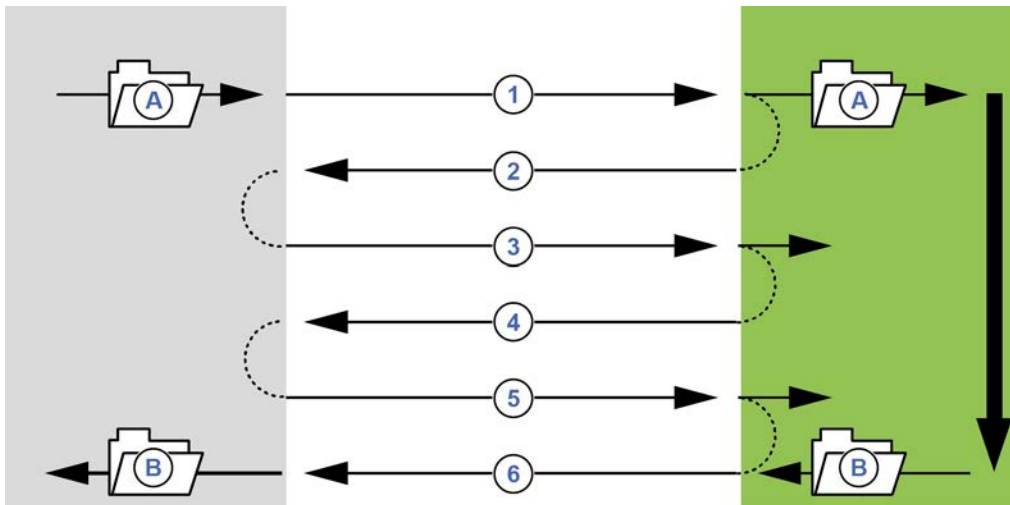

Figure 16: Sequence of acyclic PROFINET IO parameter data exchange

Item	Meaning	Comments
A	Parameter order	
W	Parameter response	
1	Write Request (with data, Slot 3...10)	By means of a "Write Request" the data record is transferred to the IO device as a parameter order.
2	Write Response (without data, Slot 3...10)	With "Write Response" the IO controller receives confirmation of the receipt of the message.
3	Read Request (without data, Slot 3...10)	With a "Read Request" the IO controller orders a response from an IO device.
4	Read Response (-) (without data, Slot 3...10)	The IO device responds with a "Read Response (-)", if processing is not yet complete.
5	Read Request (without data, Slot 3...10)	With a "Read Request" the IO controller orders a response from an IO device.
6	Read Response (+) (with data, Slot 3...10)	After processing the parameter order, the IO device responds with "Read Response (+)". The parameter order is complete.

During the communication of parameter orders, the positive response from the IO device to the IO controller can be delayed by one or more communication cycles. The IO controller must therefore repeat the order until the corresponding response is received from the IO device.

2.5.6.2 Data records for acyclic parameter orders

Parameter orders are transferred as data records. The data records are generally transferred to FI 1 (Slot 3). The number of the data record determines the recipient of the parameter order:

Data record 100	Order to the bus interface (Parameter P850...P899)
Data record 101	Order to frequency inverter 1 (Parameter P000...P849 and P900...P999)
Data record 102	Order to frequency inverter 2 (Parameter P000...P849 and P900...P999)
...	
Data record 108	Order to frequency inverter 8 (Parameter P000...P849 and P900...P999)

The structure of these data records is described in Section  2.5.6.3 "Data record format".

Information

Parameter numbers

Getriebebau NORD GmbH & Co. KG parameter numbers P000...P999 must be converted into the numerical range 1000...1999, i.e. "1000" must be added to the parameter numbers for parameterisation.

2.5.6.3 Data record format

Parameter label PKE

The order or response and the associated parameters are encrypted in the parameter label PKE.

PKE																IND	PWE1	PWE2	
15	14	13	12	11	10	9	8	7	6	5	4	3	2	1	0				
AK				SPM	PNU														

The parameter label (PKE) is always a 16 bit value.

- PNU** Bits 0...10 contain the number of the required parameters or the number of the current parameter in the response telegram of the frequency inverter.
Parameter numbers  Manual for the relevant frequency inverter.
- SPM** Bit 11 is the toggle-bit for spontaneous messages. This function is **not** supported.
- AK** Bits 12...15 contain the order or response label.

Information

Parameter numbers

Getriebebau NORD GmbH & Co. KG parameter numbers P000...P999 must be converted into the numerical range 1000...1999, i.e. "1000" must be added to the parameter numbers for parameterisation.

Order label and response label AK

A total of 15 parameter orders can be transferred from the IO-Controller.

The right-hand column of the following table lists the corresponding label of a positive response. The label of a positive response depends on the order label.

Meaning of order labels

Order label	Function	Response label (positive)
0	No order	0
1	Order parameter value	1 or 2
2	Change parameter value (word)	1
3	Change parameter value (double word)	2
4 ¹	Reserved	—
5 ¹	Reserved	—
6	Order parameter value (array)	4 or 5
7	Change parameter value (array, word)	4
8	Change parameter value (array, double word)	5
9 ¹	Order the number of array elements	6
10 ¹	Reserved	—
11 ¹	Change parameter value (array, double word) without writing to the EEPROM	5
12 ¹	Change parameter value (array, word) without writing to the EEPROM	4
13 ¹	Change parameter value (double word) without writing to the EEPROM	2
14 ¹	Change parameter value (word) without writing to the EEPROM	1

¹ Only relevant for frequency inverters with a mounted bus interface

The SK 550P supports all of the above order codes

All other frequency inverters connected to the NORD system bus only support the order codes 1, 2, 3, 6, 7 and 8.

Meaning of response labels

Response label	Meaning
0	No response
1	Transfer parameter value (word)
2	Transfer parameter value (double word)
4	Transfer parameter value (array, word)
5	Transfer parameter value (array, double word)
6	Transfer the number of array elements
7	Order cannot be executed (with error number in PWE2)

The label for a negative response is always the value "7" (order cannot be executed) for all order labels. In case of a negative response, an error message is also listed in the response from the frequency inverter in PWE2.

Meaning of error messages in parameter value PWE2

Error message	Meaning
0	Invalid parameter number
1	Parameter value cannot be changed
2	Lower or upper value limit exceeded
3	Incorrect sub-index
4	No array
5	Invalid data type
6	Only resettable (only 0 may be written)
7	Description element cannot be changed
9	Description data not present
201	Invalid order element in the last order received
202	Internal response label cannot be depicted

**Information****Order and response labels**

Both the order label and the response label are abbreviated as "AK" in the data telegram. Because of this, especially the response or order labels "AK1", "AK2" and "AK4" to "AK7" must be carefully interpreted.

Parameter index IND

The structure and function of the parameter index depends on the type of parameter to be transmitted.

PKE	IND																PWE1	PWE2
	15	14	13	12	11	10	9	8	7	6	5	4	3	2	1	0		
	P1...P4								No information (all "0")									
	Arrays 1...64								P1...P4									
	Sub-index																	

For **values which depend on the parameter set**, the parameter set can be selected via Bit 8 and Bit 9 of the index (0 = Parameter set 1, 1 = Parameter set 2 etc.).

For **array parameters** the sub-index can be addressed via Bit 10 to Bit 15 (0 = Array element 1, 1 = Array element 2 etc.).

For **parameters which do not depend on the parameter set**, Bit 8 to Bit 15 are used for the sub-index. In order for the sub-index to be effective, the corresponding order label (numbers 6, 7, 8 and 11 and 12) must be used.

Examples for address formation for array parameters which depend on parameter sets

Array element						Parameter set									
15	14	13	12	11	10	9	8	7	6	5	4	3	2	1	0
0	0	0	1	0	1	0	1	No information (all "0")							
5 (0001 01b)						2 (01b)									

Array element						Parameter set		No information							
15	14	13	12	11	10	9	8	7	6	5	4	3	2	1	0
0	1	0	1	0	1	1	1	No information (all "0")							
21 (0101 01b)						4 (11b)									

Structure of parameter and sub-index values  Manual for the relevant frequency inverter.

Parameter value PWE

According to the parameter, parameter values are transmitted as a word (16 Bit) or as a double word (32 Bit). For negative values, the High bytes must be filled up with "FFh"

The parameter value is transferred as an integer value.

For parameters with resolutions "0.1" or "0.01" the parameter value must be multiplied by the inverse of the resolution.

Example

A run-up time of 99.99 seconds is to be set.

$$99.99s = \frac{99.99 \times 1}{0.01} = 99.99 \times 100 = 9999$$

The value "9999" (270Fh) must be transferred.

2.5.6.4 Examples of data record transfer

Reading of parameter P717 current speed

Data record 100 is used.

Example telegram

Field	Data size	Byte	Date	Explanation
Order label AK	1 Byte (upper Nibble)	2	1h	Order parameter value (read)
and Parameter value PWE	1 Byte (lower Nibble)			6B5h
			16B5h	
Parameter index	2 Byte	3	00h	Parameter sub-index
		4	00h	
Parameter value	4 Byte	5	00h	Setting value not set with read order
		6	00h	
		7	00h	
		8	00h	

Example code (SIMATIC STEP 7 V5.5)	Explanation
CALL „WRREC“, DB53 REQ :=#bStart ID :=DW#16#7FC INDEX :=100 LEN :=8 DONE :=#bEnd BUSY :=#bBusy ERROR :=#bError STATUS :=wStatus RECORD :=P#DB10.DBX0.0 BYTE 8	→ Write Request → Diagnosis address → Data record 100 → Length: 8 Byte → Data: 16h,B5h, 00h,00h, 00h,00h, 00h,00h
CALL “RDREC”, DB52 REQ :=#bStart ID :=DW#16#7FC INDEX :=100 MLEN :=8 VALID :=... BUSY :=... ERROR :=... STATUS :=... LEN :=... RECORD :=P#DB10.DBX12.0 BYTE 8	→ Read Response → Diagnosis address → Data record 100 → Response: 16h,B5h, 00h,00h, 00h,00h, 03h,FCh
Read value: P717 = 1020 (03FCh)	

Writing of parameter P102 acceleration time, Index 1

Data record 101 is used.

Example telegram

Field	Data size	Byte	Date	Explanation
Order label AK	1 Byte (upper Nibble)	2	2h	Order parameter value (read)
and Parameter value PWE	1 Byte (lower Nibble)		44Eh	
			244Eh	
Parameter index	2 Byte	3	01h	Parameter sub-index
		4	00h	
Parameter value	4 Byte	5	00h	The time "2.5 s" (250 = FAh) is to be set.
		6	00h	
		7	00h	
		8	FAh	

Example code (SIMATIC STEP 7 V5.5)	Explanation
CALL „WRREC“, DB53 REQ :=#bStart ID :=DW#16#7FC INDEX :=101 LEN :=8 DONE :=#bEnd BUSY :=#bBusy ERROR :=#bError STATUS :=wStatus RECORD :=P#DB10.DBX0.0 BYTE 8	→ Write Request → Diagnosis address → Data record 101 → Length: 8 Byte → Data: 24h, 4Eh, 01h, 00h, 00h, 00h, 00h, FAh
CALL “RDREC”, DB52 REQ :=#bStart ID :=DW#16#7FC INDEX :=101 MLEN :=8 VALID :=... BUSY :=... ERROR :=... STATUS :=... LEN :=... RECORD :=P#DB10.DBX12.0 BYTE 8	→ Read Response → Reference → Data record 101 → Response: 14h, 4Eh, 01h, 00h, 00h, 00h, 00h, 00h

Telegram structure for parameterisation via PPO1 or PPO2

The parameter **P102 acceleration time** is to be set to the value "10 s" in parameter set 3 (only the PKW channel is considered). As the acceleration time has an internal resolution of "0.01 s" in the FI, the parameter value "1000" ("3E8h") must be transferred.

Procedure

1. Specify the order label (CAK 7 = "Change parameter value (Array, Word)").
2. Select parameter (P102 = P66h).
3. Select parameter set 3 (IND = 02)
4. Set parameter value (1000 = 3E8h).
5. Check response telegram (positive for array word 4)

Order telegram from IO controller

Word	1		2		3		4	
Byte	0	1	2	3	4	5	6	7
Designation	PKE	PKE	IND	IND	PWE	PWE	PWE	PWE
Value	70h	66h	02h	00h	00h	00h	03h	E8h

Response telegram from frequency inverter (after complete processing of the order)

Word	1		2		3		4	
Byte	3	4	5	6	7	8	9	10
Designation	PKE	PKE	IND	IND	PWE	PWE	PWE	PWE
Value	40h	66h	02h	00h	00h	00h	03h	E8h

3 Initial setup

3.1 Commissioning of the NORD system bus

Up to 8 frequency inverters with the corresponding peripherals (e.g. absolute encoders) can be connected to a NORD system bus.

Electrical Connection

The electrical connection to the system bus is made via terminal X15.



Addressing

All participants on the NORD system bus (bus nodes) must be assigned a unique address (CAN ID).

P515[1] = 32

Further frequency inverters must be assigned the CAN IDs 34, 36, 37, 38, 40, 42, 44, and 46. The unique assignment of peripheral bus participants (e.g. absolute encoders) to a specific frequency inverter is made at the same time via the CAN ID. This is carried out using the following equation:

$$\text{Absolute encoder address} = \text{CAN ID of the frequency inverter} + 1$$

This results in the following matrix:

Device	FI 1	AG1	FI 2	AG2	...
CAN ID	32	33	34	35	...

Assignment of the CAN ID of the frequency inverter is made via the parameter P515 "CAN Address" in array element [-01] "Slave Address". Assignment of an absolute encoder is usually made via its DIP switches (note the description of the absolute encoder).

Terminating resistor

The termination resistor must be activated on the first and last participant in the system bus.
This is done by setting the "CAN" DIP switch on terminal block X15 to the "ON" position.



DIP switch

ON - OFF



Bus speed

The bus speed of the frequency inverter must be set to "250 kBaud" (P514 "CAN baud rate") This applies for all bus nodes, i.e. also for connected absolute encoders.

3.2 Connecting the field bus

The electrical connection to the field bus system is made via the two RJ45 sockets (X17).



Field bus connection

RJ45 (1) RJ45 (2)

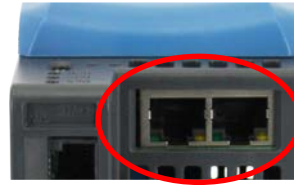

Connection socket assignment

	RJ45 (1)	RJ45 (2)
PROFINET IO	Port 1	Port 2
Ethernet/IP	Port 1	Port 2
EtherCAT	IN	OUT
POWERLINK	Port 1	Port 2

3.3 Setting the field bus protocol

The frequency inverter can communicate with various field bus systems via the field bus interface. The protocol is set with parameter **P899**. The following values are possible:

- 0: No change
- 1: PROFINET IO
- 2: EtherCAT
- 3: Ethernet/IP
- 4: POWERLINK

After successful completion of the change, the parameter resets to the setting 0. For successful change of the field bus system, there must be no communication via Ethernet, or control is not via Ethernet (**P509/P510**)

The present field bus protocol can be read out with parameter **P870**.

3.4 Installing the device description file

In order for the frequency inverter to be identified by the bus master during the bus scan, the bus master requires a device description file.

The present device description file which is necessary for detection of the frequency inverter can be downloaded from our website www.nord.com, directly under the link

[NORDAC Options](#).

The device description file contains a description of the device characteristics of the frequency inverter.

3.5 Setting up the EtherNet/IP

The bus interface must be set up in order to commission the field bus system. This consists of the following work:

Type of work	Description 
Configure the control project	Section 3.4 "Installing the device description file"
Assign the bus address	Section 3.5.2 "EtherNet/IP field bus address"
Make the required parameter settings	Section 4 "Parameters"

The bus master must first be configured for communication with the frequency inverter (PLC project of the bus master). The configuration must be produced with a software system for EtherNet/IP field bus systems.

An example of the procedure for setting up the field bus system can be found at the end of this section ( Section 3.9 "Example: Commissioning the field bus communication")

Detailed information about EMC compliant installation can be found in the Technical Information [TI 80_0011](#) under www.nord.com

3.5.1 Automatic device detection

In order for the frequency inverter to be automatically detected by the bus master during the bus scan, the following settings must be made in the configuration software after installation of the device description file:

- Enter the frequency inverter in the EtherNet/IP field bus system
- Specify the characteristics (Assembly, IP address) of the frequency inverter

3.5.2 EtherNet/IP field bus address

In order for the frequency inverter to be detected by the bus master, an IP address must be assigned to the inverter. The settings can be made by two different methods

1. Setting the IP address via DHCP or BOOTUP mode

Set parameter **P856 Addressing mode** to "DHCP" or "BOOTUP" ( Section 4.2.2 "EtherNet/IP standard parameters"), then set up the frequency inverter in the EtherNet/IP configuration software.

2. Set the IP address via parameters in the NORDCON software as described below.

Information

On setting parameter **P865** to the value "0" the IP address from the settings in parameters **P850 IP address**, **P851 IP Sub-net Mask** and **P852 IP Gateway** is adopted.

Setting the IP address via parameters in the NORDCON software (Item 2.)

The following parameters must be set in the NORDCON software::

- **P856 Addressing Mode**
- **P850 IP Address**
- **P161 IP Sub-Net Mask**
- **P852 IP Gateway** (if the gateway function is configured)

Requirement

- The EtherNet/IP field bus system has been installed and commissioned according to the manufacturer's instructions.
- A NORDCON computer is available ( [BU 0000](#)).

Procedure

1. Open the entry for the frequency inverter in the tree directory of the NORDCON software, call up the standard parameter **P856 Addressing Mode**, select the setting "0" and save this with "**ENTER**".
2. Call up the standard parameter **P850 IP Address**, enter the IP address and save with "**ENTER**".
3. Call up the standard parameter **P851 IP Sub-net Mask**, enter the IP sub-net mask and save with "**ENTER**".
4. Call up the standard parameter **P852 IP Gateway**, enter the IP address for the gateway function and save this with "**ENTER**".
5. Restart the frequency inverter (switch the power supply off and on again) so that the parameter settings are read in.

3.6 Setting up EtherCAT

The frequency inverter must be set up in order to commission the field bus system. This consists of the following work:

Type of work	Description 
Configure the control project	Section 3.4 "Installing the device description file"
Assign the bus address	Section 3.6.2 "EtherCAT field bus address"
Make the required parameter settings	Section 4 "Parameters"

First of all, the bus master (PLC project) must be configured. The configuration must be performed with a software system for EtherCAT field bus systems, real time execution and diagnosis (e.g. "TwinCAT" from Beckhoff Automation GmbH & Co. KG).

An example of the procedure for setting up the field bus system can be found at the end of this section ( Section 3.9 "Example: Commissioning the field bus communication")

Detailed information about EMC compliant installation can be found in the Technical Information [TI 80_0011](#) under www.nord.com

3.6.1 Automatic device detection

After installation of the device description file, the frequency inverter is automatically detected and uniquely identified by the configuration software in a bus scan. This is carried out via the parameters

- "Software Version",
- "Vendor ID" (NORD manufacturer code "00000538h") and
- "Product Code",

which are saved in the "CoE directory" ( Section 2.2.7 "Parameter data transmission").

The parameter "Product Code" is communicated to the bus master during the start-up phase of the field bus system. The bus master then adopts the settings from the device description file on the basis of this code.

3.6.2 EtherCAT field bus address

EtherCat devices do not need to be addressed. Addressing is performed automatically by the bus master (PLC) according to their physical sequence on the bus.

If the Hot Connect function is used, a unique address ("Second Address") must be assigned to the frequency inverter. Assignment is made via parameter **P850 Second Address**.

The address is read out by the frequency inverter when it is connected to the power supply ("POWER ON").

Information

Bus participants without Hot Connect function must always be physically arranged at the start of the field bus system. No bus participant without this function may be located in the EtherCAT line after a bus participant with the Hot Connect function.

Requirement

- The EtherCAT field bus system has been installed and commissioned according to the manufacturer's instructions.

Procedure

1. Set the bus address ("Second Address") with parameter **P850 Second Address**.
2. Configure the frequency inverter for the Hot Connect function (ADO 0x134) in the operator's EtherCAT configuration project.

3.7 Setting up POWERLINK

The frequency inverter must be set up for field bus communication in order to commission the field bus system. This consists of the following work:

Type of work	Description 
Configure the control project	Section 3.4 "Installing the device description file"
Assign the bus address	Section 3.7.3 "POWERLINK field bus address"
Make the required parameter settings	Section 4 "Parameters"

First of all, the bus master (PLC project) must be configured. The configuration must be produced with a software system for POWERLINK field bus systems.

An example of the procedure for setting up the field bus system can be found at the end of this section ( Section 3.9 "Example: Commissioning the field bus communication")

Detailed information about EMC compliant installation can be found in the Technical Information [TI 80_0011](#) under www.nord.com

3.7.1 Automatic device detection

In order for the frequency inverter to be automatically detected by the bus master during the bus scan, the following settings must be made in the configuration software after installation of the device description file:

- Enter the frequency inverter in the POWERLINK field bus system
- Enter the frequency inverter from the PLC database into the project (add Controlled Node)
- Address the frequency inverter (assign POWERLINK Node ID)
- Link the process data to variables

3.7.2 Initialisation of parameters

In order to write parameters automatically when the PLC is started, the relevant device-specific parameters must be provided with an initial value in the device configuration of the PLC. All of the parameters are written once when the PLC establishes communication with the Controlled Node.

Information

The frequency inverter must be ready for operation when the PLC is started. Otherwise it cannot save any data and responds with an error. If the PLC module monitoring ( Section 5.4 "Troubleshooting – Industrial Ethernet") is enabled, the PLC then switches to Service Mode.

3.7.3 POWERLINK field bus address

In order for the frequency inverter to be detected by the bus master, an IP address must be assigned to the inverter.

Only the fourth byte of the IP address (NODE ID) needs to be set. The first three bytes of the IP address and the four bytes of the sub-net mask are specified by POWERLINK.

IP address	192.168.100.xxx (xxx = Node-ID)
Sub-net mask	255.255.255.0

The following frequency inverter parameters must be set:

- **P850 Node ID**
- **P852 IP Gateway** (if the gateway function is configured)

Information

POWERLINK prescribes certain ranges for the allocation of addresses, which must be complied with.  Section 4.2.3 "POWERLINK standard parameters".

Requirement

- The POWERLINK field bus system has been installed and commissioned according to the manufacturer's instructions.
- A parameterisation tool (e.g. NORDCON or ParameterBox) is available.

Procedure

1. Call up parameter **P850 Node ID** and set the Node ID.
2. Call up parameter **P852 IP Gateway** and set the IP address for the gateway.

Information

The IP address of the gateway must only be in the range "192.168.100.1" ... "192.168.100.240". Otherwise the error "5605 set config." will be triggered.

3. Restart the frequency inverter (switch the power supply off and on again) so that the parameter settings are read in.

3.8 Setting up PROFINET IO

The bus interface must be set up in order to commission the field bus system. This consists of the following work:

Type of work	Description 
Configure the control project	Section 3.4 "Installing the device description file"
Assign the bus address	Section 3.8.1 "Addressing the frequency inverter "
Make the required parameter settings	Section 4 "Parameters"

The bus master must first be configured for communication with the frequency inverter (PLC project of the IO controller). The configuration must be produced with a software system for PROFINET IO field bus systems (e.g. "Simatic Step 7" from Siemens AG).

For integration of NORD frequency inverters into the Siemens AG SIMATIC Manager, Getriebebau NORD GmbH & Co. KG provides standard S7 modules, which can be used for both PROFINET IO as well as for PROFIBUS field bus systems ( Manual [BU 0940](#)).

An example of the procedure for setting up the field bus system can be found at the end of this section ( Section 3.9 "Example: Commissioning the field bus communication")

Detailed information about EMC compliant installation can be found in the Technical Information [TI 80_0011](#) under www.nord.com

3.8.1 Addressing the frequency inverter

In order for the frequency inverter to be detected by the IO controller, an IP address and a device name must be assigned to the frequency inverter. The settings must be made in both the operator's PROFINET IO configuration software as well as in the NORDCON software.

The following parameters are relevant for establishing communication via PROFINET IO:

- **P850 IP Address**
- **P161 IP Sub-net Mask**
- **P854 Device Name**
- **P852 IP Gateway** (if the gateway function is configured)

Only the assignment of the device name (**P854**) by the commissioner is necessary. Assignment of the IP address data (**P850, P851, P852**) is normally carried out automatically by the IO controller.

Requirement

- The PROFINET IO field bus system has been installed and commissioned according to the manufacturer's instructions.
- Access to the parameters is possible (a TU5-CTR module or a NORDCON computer ([BU 0000](#)) are available).

Procedure

1. Assign a device name, an IP address and a sub-net mask and if necessary activate the gateway function in the PROFINET IO configuration software for the bus master.
2. Call up parameter **P854 Device Name** of the frequency inverter, enter the device name and save.

 Information

In order for the frequency inverter to be detected when the IO controller is started up, the device name which is entered here must conform with the device name which is assigned in the PLC project.

Observe the following conventions when entering the device name:

- The device name may have a maximum of 127 characters. Lower case letters a...z, numbers 0...9, hyphens /- and fullstops "." are permissible.
- A character string between two hyphens or two full stops may only have a maximum length of 63 characters.
- The device name must not contain any special characters (umlauts, brackets, slashes and underscores etc.) or spaces.
- The device name must not begin or end with a hyphen.
- The device name must not begin or end with a number.
- The device name must not have the format "n.n.n.n" or start with the character sequence "port-
nnn" (n = 0...9).

In addition, the IP address data can be parameterised as follows:

3. Enter parameter **P850 IP Address**, enter the IP address and save.

 Information

If the IP address of the frequency inverter has been configured in the PLC project, this is automatically assigned to the bus interface when the IO controller is started up. In this case, the currently set IP address can be obtained via parameter **P875**.

If the IP address which is entered does not conform with the IP sub-net mask which is entered in parameter **P851** the IP sub-net mask is corrected automatically.

4. Enter parameter **P851 IP Sub-net Mask**, enter the IP sub-net mask and save.

 Information

If the IP sub-net mask has been configured in the PLC project, this is automatically assigned to the frequency inverter when the IO controller is started up. In this case, the currently set IP sub-net mask can be determined via parameter **P876**.

The IP sub-net mask is only saved after a value is entered in the array element [-04].

If the IP sub-net mask does not conform with the IP address which is entered in **P850** the entry is not saved.





5. Call up parameter **P852 IP Gateway**, enter the IP address of the gateway and save.

 Information

If the IP address for the gateway function has been configured in the PLC project, this is automatically assigned to the frequency inverter when the IO controller is started up. In this case, the present IP address can be determined via parameter **P877**.

3.8.2 Specify the data format for process data

For the cyclic transfer of process data for the frequency inverter, the data format must be specified in the configuration project. Detailed information about the process data can be found in the following sections:

- EtherCAT  Section 2.2.6 "Transfer of process data"
- EtherNet/IP  Section 2.3.4 "Transfer of process data"
- POWERLINK  Section 2.4.5 "Transfer of process data "
- PROFINET IO  Section 2.5.5 "Transfer of process data"

3.9 Example: Commissioning the field bus communication





The following example contains an overview of the necessary steps for commissioning the frequency inverter in a field bus system. The example does not contain details of application-specific settings (motor data, control parameters, etc.)

Example:

3 frequency inverters are to be independently controlled via a field bus interface in positioning operation with a single speed and a single position specification.

Frequency inverter type	Name	Connected motor	Characteristics
Frequency inverter SK 550P	FI 1	4-pole/n=1390 rpm/50 Hz	Motor with CANopen absolute encoder AG 1
Frequency inverter SK 5x0P	FI 2	4-pole/n=1390 rpm/50 Hz	Motor with CANopen absolute encoder AG 2
Frequency inverter SK 5x0P	FI 3	4-pole/n=1390 rpm/50 Hz	Motor with CANopen absolute encoder AG 3

Communication	Step	Explanation		
NORD system bus	1	Set the termination resistors.		
		Set the CAN DIP switch on frequency inverter FI 1 to the "ON" position.		
		Set the CAN DIP switch on frequency inverter FI 2 to the "OFF" position.		
	2	Set up system bus.	Set the CAN DIP switch on frequency inverter FI 3 to the "ON" position.	
		3	Set the system bus addresses.	FI via P515 , absolute encoder via DIP switches
			FI 1	Address "32"
	FI 2		Address "34"	
	FI 3		Address "36"	
	AG 1		Address "33"	
	AG 2		Address "35"	
4	Set the system bus baud rate.	AG 3	Address "37"	
		Set "250 kBaud" on FI 1 to FI 3 and on AG 1 to AG 3.		

Communication	Step	Explanation	
	5	Set the parameters for system bus communication.	
		Set the following parameters on each frequency inverter:	
		P509 6 (CANopen)	
		P510, [-01] 0 (Auto)	
		P510, [-02] 0 (Auto)	
		P543, [-01] 1 (Actual Frequency)	
		P543, [-02] 10 (Actual Position incl. LowWord)	
		P543, [-03] 15 (Actual Position incl. HighWord)	
		P546, [-01] 1 (Setpoint Frequency)	
P546, [-02] 23 (Setpoint Frequency incl. LowWord)			
P546, [-03] 24 (Setpoint Frequency incl. HighWord)			
Field bus	6	Set up the field bus communication.	 Sections 3.5 "Setting up the EtherNet/IP" to 3.8 "Setting up PROFINET IO"
NORD system bus	7	Set the parameters for system bus monitoring.	Set the following parameters on each frequency inverter ( BU 0600):
		P120, [-01] 1 (Auto) or 2 (monitoring active immediately)	
	8	Check the system bus communication.	Check the display of the following information parameters on all frequency inverters ( BU 0600):
		P748 "CANopen status"	
		P740, [-01] "Control word" ¹ (047Eh = "Ready for switch-on")	
P740, [-02] "Setpoint 1"			
P741, [-01] "Status word" (0B31h = "Ready for switch-on")			
P741, [-02] "Actual Value 1"			
Field bus	9	Check the field bus communication.	Check the display of the following information parameters ( Section 4.4 "Field bus-specific information parameters"):
		P872 "Bus status"	
		P873 "Process data In ETH"	
P874 "Process data Out ETH"			

¹ On condition that the PLC has already sent the control word. Otherwise "0h" is displayed in the parameter.

4 Parameters

The frequency inverter parameters are communicated as words (16 Bit/Word). The exception to this are position values (POSIICON) which are communicated as double words (32 Bit).

For field bus operation, several parameters must be set on the frequency inverter.

The parameters can be set with

- An SK TU5-CTR control module,
- NORDCON software ( Manual [BU 0000](#)) or
- The operator's PLC project.

The parameters are classified as

- NORD-specific and field bus-specific standard parameters and
- NORD-specific and field bus-specific information parameters:

The basic settings of the frequency inverter can be made via NORD standard parameters.

Field-bus specific settings of the bus interface can be made via the field bus-specific standard parameters.

NORD information parameters are used to display current and archived error messages, as well as actual operating states.

Field bus-specific information parameters are used to display statuses and settings which are specific for the field bus.

Parameter no.	Description
P850...858	Field bus-specific standard parameters (can be set and saved)
P870...874	NORD information parameters (display)
P875...879	Field bus-specific information parameters (display)

The following sections contain a detailed description of the parameters which are relevant for field bus communication.

4.1 NORD standard parameters

P899	Changing the bus protocol													
Setting range	0...4													
Factory setting	{ 0 }													
Description	Enter the relevant value to change the field bus protocol. After successful completion of the change, the parameter resets to the setting 0. In order to change the field bus protocol, there must be no communication via Ethernet, or control is not via Ethernet (P509/P5109).													
Setting values	<table border="1"> <thead> <tr> <th>Value</th> <th>Meaning</th> </tr> </thead> <tbody> <tr> <td>0</td> <td>No action</td> </tr> <tr> <td>1</td> <td>PROFINET IO</td> </tr> <tr> <td>2</td> <td>EtherCAT</td> </tr> <tr> <td>3</td> <td>Ethernet/IP</td> </tr> <tr> <td>4</td> <td>Powerlink</td> </tr> </tbody> </table>	Value	Meaning	0	No action	1	PROFINET IO	2	EtherCAT	3	Ethernet/IP	4	Powerlink	
Value	Meaning													
0	No action													
1	PROFINET IO													
2	EtherCAT													
3	Ethernet/IP													
4	Powerlink													

4.2 Field bus-specific standard parameters

4.2.1 EtherCAT standard parameters

P850	Second Address			
Setting range	0...4096			
Factory setting	{ 0 }			
Description	Setting of the "Second Address" for the Hot Connect function.			
Note	The address which is set is only adopted by the frequency inverter after a "POWER ON".			

4.2.2 EtherNet/IP standard parameters

P850	IP address			
Setting range	0...255			
Array	[-01] = IP-High (NET-ID)		[-03] = IP (NET-ID)	
	[-02] = IP (NET-ID)		[-04] = IP Lo (Host)	
Factory setting	{ [-01] = 192 }	{ [-02] = 168 }	{ [-03] = 1 }	{ [-04] = 100 }
Description	Set the 4 byte IP address for the frequency inverter. After setting, restart the frequency inverter (switch the power supply off and on again) so that the parameter setting is read in.			
Note	<ul style="list-style-type: none"> In order for the set IP address to be adopted, parameter P856 Addressing Mode must be set to the value "0". The IP address which is set at present can be determined via the parameter P875. 			
P851	IP sub-net mask			
Setting range	0...255			
Array	[-01] = IP Sub 1	[-02] = IP Sub 2	[-03] = IP Sub 3	[-04] = IP Sub 4
Factory setting	{ [-01] = 255 }	{ [-02] = 255 }	{ [-03] = 255 }	{ [-04] = 0 }
Description	Set the 4 byte IP sub-net mask. After setting, restart the frequency inverter (switch the power supply off and on again) so that the parameter setting is read in.			
Note	<ul style="list-style-type: none"> In order for the set IP address to be adopted, parameter P856 Addressing Mode must be set to the value "0". The address of the IP sub-mask which is set can be determined via the parameter P876. 			
P852	IP Gateway			
Setting range	0...255			
Array	[-01] = IP High (NET-ID)		[-03] = IP (NET-ID)	
	[-02] = IP (NET-ID)		[-04] = IP Lo (Host)	
Factory setting	{ [-01] = 0 }	{ [-02] = 0 }	{ [-03] = 0 }	{ [-04] = 0 }
Description	Set the 4 byte IP address for the gateway. After setting, restart the frequency inverter (switch the power supply off and on again) so that the parameter setting is read in.			

P853	Right TCP Ethernet																
Setting range	0...3																
Factory setting	{ 0 }																
Description	Specifies the access rights for parameters and setpoints for TCP access.																
Note	Writing only possible via USS or USB.																
Setting values	<table border="1"> <thead> <tr> <th>Value</th> <th colspan="2">Meaning</th> </tr> </thead> <tbody> <tr> <td>0</td> <td colspan="2">Read parameter/control Off</td> </tr> <tr> <td>1</td> <td colspan="2">Read & write parameter/control Off</td> </tr> <tr> <td>2</td> <td colspan="2">Read parameter/control On</td> </tr> <tr> <td>3</td> <td colspan="2">Read & write parameter/control On</td> </tr> </tbody> </table>		Value	Meaning		0	Read parameter/control Off		1	Read & write parameter/control Off		2	Read parameter/control On		3	Read & write parameter/control On	
Value	Meaning																
0	Read parameter/control Off																
1	Read & write parameter/control Off																
2	Read parameter/control On																
3	Read & write parameter/control On																

P856	Addressing Mode													
Setting range	0...2													
Factory setting	{ 1 }													
Description	The setting of this parameter determines the method by which the IP address is set. After setting, restart the frequency inverter (switch the power supply off and on again) so that the parameter setting is read in.													
Note	<ul style="list-style-type: none"> If this parameter is set to the value "0", the IP address is adopted from the settings of parameters P850, P851 and P852. 													
Setting values	<table border="1"> <thead> <tr> <th>Value</th> <th colspan="2">Meaning</th> </tr> </thead> <tbody> <tr> <td>0</td> <td>Fixed</td> <td>Set parameters P850, P851, P852</td> </tr> <tr> <td>1</td> <td>BOOTP</td> <td>Set the IP configuration in the EtherNet/IP configuration software in BOOTUP mode</td> </tr> <tr> <td>2</td> <td>DHCP</td> <td>Set the IP configuration in the EtherNet/IP configuration software via DHCP</td> </tr> </tbody> </table>		Value	Meaning		0	Fixed	Set parameters P850, P851, P852	1	BOOTP	Set the IP configuration in the EtherNet/IP configuration software in BOOTUP mode	2	DHCP	Set the IP configuration in the EtherNet/IP configuration software via DHCP
Value	Meaning													
0	Fixed	Set parameters P850, P851, P852												
1	BOOTP	Set the IP configuration in the EtherNet/IP configuration software in BOOTUP mode												
2	DHCP	Set the IP configuration in the EtherNet/IP configuration software via DHCP												

4.2.3 POWERLINK standard parameters

P850	Node ID
Setting range	0...255
Description	Set the node ID. After setting, restart the frequency inverter (switch the power supply off and on again) so that the parameter setting is read in.
Note	<ul style="list-style-type: none"> The current address of the IP sub-mask which can be determined via the parameter P875 [-04].

P852	IP Gateway	
Setting range	0...255	
Array	[-01] = IP High (NET-ID)	[-03] = IP (NET-ID)
	[-02] = IP (NET-ID)	[-04] = IP Lo (Host)
Factory setting	{ [-01] = 0 }	{ [-03] = 0 }
	{ [-02] = 0 }	{ [-04] = 0 }
Description	Set the 4 byte IP address for the gateway. After setting, restart the frequency inverter (switch the power supply off and on again) so that the parameter setting is read in.	
Note	The IP address of the gateway must only be in the range "192.168.100.1" ... "192.168.100.240". Otherwise the error "5605 set config." will be triggered.	

P853	Right TCP Ethernet										
Setting range	0...3										
Factory setting	{ 0 }										
Description	Specifies the access rights for parameters and setpoints for TCP access.										
Note	Writing only possible via USS or USB.										
Setting values	<table border="1"> <thead> <tr> <th>Value</th> <th>Meaning</th> </tr> </thead> <tbody> <tr> <td>0</td> <td>Read parameter/control Off</td> </tr> <tr> <td>1</td> <td>Read & write parameter/control Off</td> </tr> <tr> <td>2</td> <td>Read parameter/control On</td> </tr> <tr> <td>3</td> <td>Read & write parameter/control On</td> </tr> </tbody> </table>	Value	Meaning	0	Read parameter/control Off	1	Read & write parameter/control Off	2	Read parameter/control On	3	Read & write parameter/control On
Value	Meaning										
0	Read parameter/control Off										
1	Read & write parameter/control Off										
2	Read parameter/control On										
3	Read & write parameter/control On										

P854	Device name
Setting range	0...122 (ASCII)
Factory setting	{ 0 }
Description	Enter the device name for the frequency inverter in the POWERLINK bus system. After setting, restart the frequency inverter (switch the power supply off and on again) so that the parameter setting is read in.
Note	If no device name is entered here, the frequency inverter is registered in the POWERLINK field bus system with the standard name "Powerlink <nnn>-0xED" (nnn = Node ID).

P858	POWERLINK cycle			
Setting range	400...2000 μ s			
Factory setting	{ 1000 }			
Description	Setting of the bus cycle time which is used for synchronisation of the frequency inverter (Controlled Node CN) with the bus master (Managing Node MN).			

4.2.4 PROFINET IO standard parameters

P850	IP address			
Setting range	0...255			
Array	[-01] = IP-High (NET-ID)		[-03] = IP (NET-ID)	
	[-02] = IP (NET-ID)		[-04] = IP Lo (Host)	
Factory setting	{ [-01] = 192 }	{ [-02] = 168 }	{ [-03] = 20 }	{ [-04] = 200 }
Description	Set the 4 byte IP address for the frequency inverter.			
Note	<p>If the IP address of the frequency inverter has been configured in the PLC project, this is automatically assigned to the frequency inverter when the IO controller is started up. This parameter is then set to "0". In this case, the currently set IP address can be obtained via parameter P875.</p> <p>In order for the set IP address to be adopted, parameter P856 Addressing Mode must be set to the value "0".</p> <p>If the IP address which is entered does not conform with the IP sub-net mask which is entered in parameter P851 the IP sub-net mask is corrected automatically.</p> <p>If the IP address is changed (e.g. with NORDCON software), this is only saved after a value is entered in the element [-04].</p>			
P851	IP sub-net mask			
Setting range	0...255			
Array	[-01] = IP Sub 1	[-02] = IP Sub 2	[-03] = IP Sub 3	[-04] = IP Sub 4
Factory setting	{ [-01] = 255 }	{ [-02] = 255 }	{ [-03] = 255 }	{ [-04] = 0 }
Description	Set the 4 byte IP sub-net mask.			
Note	<p>If the IP sub-net mask has been configured in the PLC project, this is automatically assigned when the IO controller is started up. This parameter is then set to "0". In this case, the currently set IP sub-net mask can be determined via parameter P876.</p> <p>In order for the set IP address to be adopted, parameter P856 Addressing Mode must be set to the value "0".</p> <p>If the IP sub-net mask is changed (e.g. with NORD CON software), this is only saved after a value is entered in the array element [-04].</p> <p>If the IP sub-net mask does not conform with the IP address which is entered in P850 the entry is not saved.</p>			

P852	IP Gateway			
Setting range	0...255			
Array	[-01] = IP High (NET-ID)		[-03] = IP (NET-ID)	
	[-02] = IP (NET-ID)		[-04] = IP Lo (Host)	
Factory setting	{ [-01] = 0 }	{ [-02] = 0 }	{ [-03] = 0 }	{ [-04] = 0 }
Description	Set the 4 byte IP address for the gateway.			
Note	<p>If the IP address of the gateway has been configured in the PLC project, this is automatically assigned to the frequency inverter when the IO controller is started up. This parameter is then set to "0". In this case, the currently set IP address can be obtained via parameter P877.</p> <p>In order for the set IP address to be adopted, parameter P856 Addressing Mode must be set to the value "0".</p> <p>If the IP address is changed (e.g. with NORDCON software), this is only saved after a value is entered in the index [-04].</p>			
P854	Device name			
Setting range	0...122 (ASCII)			
Factory setting	{ 0 }			
Description	Enter the device name for the frequency inverter in the field bus system.			
Note	<p>In order for the frequency inverter to be detected when the IO controller is started up, the device name which is entered here must conform with the device name which is assigned in the PLC project.</p> <p>Observe the following conventions when entering the device name:</p> <ul style="list-style-type: none"> • The device name may have a maximum of 240 characters. Lower case letters a...z, numbers 0...9, hyphens "-" and fullstops "." are permissible. • A character string between two hyphens or two full stops may only have a maximum length of 63 characters. • The device name must not contain any special characters (umlauts, brackets, slashes and underscores etc.) or spaces. • The device name must not begin or end with a hyphen. • The device name must not begin or end with a number. • The device name must not have the format "n.n.n.n" or start with the character sequence "port-<i>nnn</i>" (<i>n</i> = 0...9). 			

4.3 NORD information parameters

P870	Present bus protocol																																																																																									
Display range	0...4																																																																																									
Description	Displays the presently set bus protocol																																																																																									
Display values	<table border="1"> <thead> <tr> <th>Value</th> <th colspan="4">Meaning</th> </tr> </thead> <tbody> <tr> <td>0</td> <td colspan="4">No bus system active</td> </tr> <tr> <td>1</td> <td colspan="4">PROFINET IO</td> </tr> <tr> <td>2</td> <td colspan="4">EtherCAT</td> </tr> <tr> <td>3</td> <td colspan="4">Ethernet/IP</td> </tr> <tr> <td>4</td> <td colspan="4">Powerlink</td> </tr> </tbody> </table>					Value	Meaning				0	No bus system active				1	PROFINET IO				2	EtherCAT				3	Ethernet/IP				4	Powerlink																																																										
Value	Meaning																																																																																									
0	No bus system active																																																																																									
1	PROFINET IO																																																																																									
2	EtherCAT																																																																																									
3	Ethernet/IP																																																																																									
4	Powerlink																																																																																									
P872	Bus status																																																																																									
Display range	0...FFFFh																																																																																									
Description	Displays the operating state of the bus interface.																																																																																									
Display values	<table border="1"> <thead> <tr> <th>Bit</th> <th colspan="4">Meaning</th> </tr> </thead> <tbody> <tr> <td>0</td> <td colspan="4">Module ready for operation</td> </tr> <tr> <td>1</td> <td colspan="4">Cyclic PZD communication</td> </tr> <tr> <td>2</td> <td colspan="4">Field bus timeout</td> </tr> <tr> <td>3</td> <td colspan="4">Timeout P513</td> </tr> <tr> <td>4</td> <td colspan="4">netX not accessible</td> </tr> <tr> <td>5</td> <td colspan="4">netX in error state</td> </tr> <tr> <td>6</td> <td colspan="4">(Reserved)</td> </tr> <tr> <td>7</td> <td colspan="4">(Reserved)</td> </tr> <tr> <td>8</td> <td colspan="4">FI 1 online</td> </tr> <tr> <td>9</td> <td colspan="4">FI 2 online</td> </tr> <tr> <td>10</td> <td colspan="4">FI 3 online</td> </tr> <tr> <td>11</td> <td colspan="4">FI 4 online</td> </tr> <tr> <td>12</td> <td colspan="4">FI 5 online</td> </tr> <tr> <td>13</td> <td colspan="4">FI 6 online</td> </tr> <tr> <td>14</td> <td colspan="4">FI 7 online</td> </tr> <tr> <td>15</td> <td colspan="4">FI 8 online</td> </tr> </tbody> </table>					Bit	Meaning				0	Module ready for operation				1	Cyclic PZD communication				2	Field bus timeout				3	Timeout P513				4	netX not accessible				5	netX in error state				6	(Reserved)				7	(Reserved)				8	FI 1 online				9	FI 2 online				10	FI 3 online				11	FI 4 online				12	FI 5 online				13	FI 6 online				14	FI 7 online				15	FI 8 online			
Bit	Meaning																																																																																									
0	Module ready for operation																																																																																									
1	Cyclic PZD communication																																																																																									
2	Field bus timeout																																																																																									
3	Timeout P513																																																																																									
4	netX not accessible																																																																																									
5	netX in error state																																																																																									
6	(Reserved)																																																																																									
7	(Reserved)																																																																																									
8	FI 1 online																																																																																									
9	FI 2 online																																																																																									
10	FI 3 online																																																																																									
11	FI 4 online																																																																																									
12	FI 5 online																																																																																									
13	FI 6 online																																																																																									
14	FI 7 online																																																																																									
15	FI 8 online																																																																																									
P873	Process data bus In																																																																																									
Display range	0...FFFFh																																																																																									
Array	[-01]	Control word	[-02]...[-06]	Setpoint 1...5	to FI 1																																																																																					
	[-07]	Control word	[-08]...[-13]	Setpoint 1...5	to FI 2																																																																																					
	[-13]	Control word	[-14]...[-19]	Setpoint 1...5	to FI 3																																																																																					
	[-19]	Control word	[-20]...[-24]	Setpoint 1...5	to FI 4																																																																																					
	[-25]	Control word	[-26]...[-30]	Setpoint 1...5	to FI 5																																																																																					
	[-31]	Control word	[-32]...[-36]	Setpoint 1...5	to FI 6																																																																																					
	[-37]	Control word	[-38]...[-42]	Setpoint 1...5	to FI 7																																																																																					
	[-43]	Control word	[-44]...[-48]	Setpoint 1...5	to FI 8																																																																																					
Description	Display of data received from the bus master.																																																																																									

P874	Process data bus Out				
Display range	0...FFFFh				
Array	[-01]	Status word	[-02]...[-06] =	Actual value 1...5	from FI 1
	[-07]	Status word	[-08]...[-12]	Actual value 1...5	from FI 2
	[-13]	Status word	[-14]...[-18]	Actual value 1...5	from FI 3
	[-19]	Status word	[-20]...[-24]	Actual value 1...5	from FI 4
	[-25]	Status word	[-26]...[-30]	Actual value 1...5	from FI 5
	[-31]	Status word	[-32]...[-36]	Actual value 1...5	from FI 6
	[-37]	Status word	[-38]...[-42]	Actual value 1...5	from FI 7
	[-43]	Status word	[-44]...[-48]	Actual value 1...5	from FI 8
Description	Display of data sent from the frequency inverter to the bus master.				

4.4 Field bus-specific information parameters

4.4.1 EtherNet/IP information parameters

P875	Present IP address			
Display range	0...255			
Array	[-01]...[-04]			
Description	Displays the present IP address of the frequency inverter if only one connection is active.			
P876	Present IP sub-net mask			
Display range	0...255			
Array	[-01]...[-04]			
Description	Displays the present sub-net IP address if only one connection is active.			
P878	MAC Address			
Display range	0...FFh			
Array	[-01]...[-03] = Manufacturer ID (Getriebebau NORD GmbH & Co. KG "F0.5F.5A") [-04]...[-06] = free address area (for Getriebebau NORD GmbH & Co. KG)			
Description	Display of the unique MAC address of the frequency inverter.			
P879	Active Assembly			
Display range	0...255			
Array	[-01] = Assembly number for setpoints [-02] = Assembly number for actual values			
Description	Display of the currently assigned assembly object.			

4.4.2 POWERLINK information parameters

P875	Present IP address			
Display range	0...255			
Array	[-01]...[-04]			
Description	Displays the present IP address of the frequency inverter if only one connection is active.			
P876	Present IP sub-net mask			
Display range	0...255			
Array	[-01]...[-04]			
Description	Displays the present sub-net IP address if only one connection is active.			
P877	Present IP gateway			
Display range	0...255			
Array	[-01]...[-04]			
Description	Display of the currently set IP address for the gateway (Parameter P852).			
P878	MAC Address			
Display range	0...FFh			
Array	[-01]...[-03] = Manufacturer ID (Getriebebau NORD GmbH & Co. KG "F0.5F.5A") [-04]...[-06] = free address area (for Getriebebau NORD GmbH & Co. KG)			
Description	Display of the unique MAC address of the frequency inverter.			

4.4.3 PROFINET IO information parameters

P875	Present IP address			
Display range	0...255			
Array	[-01]...[-04]			
Description	Displays the present IP address of the frequency inverter if only one connection is active.			
Note	The IP address which is displayed here may deviate from the IP address which is set in parameter P850 (in case of addressing by the IO controller).			
P876	Present IP sub-net mask			
Display range	0...255			
Array	[-01]...[-04]			
Description	Displays the present sub-net IP address if only one connection is active.			
Note	The sub-net mask which is displayed here may deviate from the sub-net mask which is set in parameter P851 (in case of addressing by the IO controller).			
P877	Present IP gateway			
Display range	0...255			
Array	[-01]...[-04]			
Description	Display of the currently set IP address for the gateway (Parameter P852).			
P878	MAC Address			
Display range	0...FFh			
Array	[-01]...[-03] = Manufacturer ID (Getriebebau NORD GmbH & Co. KG "F0.5F.5A") [-04]...[-06] = free address area (for Getriebebau NORD GmbH & Co. KG)			
Description	Display of the unique MAC address of the frequency inverter.			

P879	PPO Type			
Display range	0...255			
Array	[-01] ... [-08] FI 1... FI 8			
Description	Display of the currently assigned PPO type			
Note	The PPO type is assigned via the PROFINET IO configuration software.			
Display values	Value	Meaning		
	3	Empty slot		
	6	PPO3		
	7	PPO4		
	8	PPO6		
	9	PPO1		
	10	PPO2		

4.5 Frequency inverter parameter settings

After addressing of the bus interface, the additional parameters of the frequency inverter must be set as listed below.

A detailed description of the parameters can be found in the manual for the frequency inverter.

Additional parameters

The following table contains a list of additional parameters which are relevant for the bus interface.

No.	Parameter name	Recommended setting	Comments
P509	Control word source	"8" = Ethernet	Further frequency inverters "6" = CANopen
P510	Setpoint source	"8" = Ethernet	Further frequency inverters "6" = CANopen
P513	Telegram downtime (Array [-3] = CANopen, [-4] = Ethernet)	Off	
P514	CAN baud rate	"5" = 250 kBaud	
P515	CAN address (Array [-01])	32	System bus address, further frequency inverters 34, 36, 38 ... 46
P543	Actual bus value Arrays [-01]...[-05]	Depending on the function: Setting according to the required functions is necessary.	Refer to the frequency inverter operating manual
P546	Function Bus setpoint Arrays [-01]...[-05]	Depending on the function: Setting according to the required functions is necessary	Refer to the frequency inverter manual

Information parameter

Information parameters are used to display current and archived error messages, as well as present operating states and settings.

The following table contains a list of information parameters which are relevant for the bus interface.

No.	Parameter name	Comments							
P700	Present operating status	Array [-01]:	Present error						
		Array [-02]:	Present warning						
		Array [-03]:	Reason for switch-on block						
		Array [-04]:	Extended present fault						
P701	Last error								
P740	PZD bus in								
P741	PZD bus out								
P744	Configuration	Array [-02]:	XU5 type						
		Possible values: <table border="1"> <thead> <tr> <th>Value</th> <th>Meaning</th> </tr> </thead> <tbody> <tr> <td>0</td> <td>No extension present</td> </tr> <tr> <td>1</td> <td>Reserved</td> </tr> <tr> <td>2</td> <td>Industrial Ethernet present</td> </tr> </tbody> </table>		Value	Meaning	0	No extension present	1	Reserved
Value	Meaning								
0	No extension present								
1	Reserved								
2	Industrial Ethernet present								
P745	Module version	Array [-07]:	XU5 version						
		Array [-08]:	XU5 revision						
		Array [-09]:	XU5 special version						
		Array [-10]:	XU5 Stack 1						
		Array [-11]:	XU5 Stack 2						
P746	Module status	Array [-03]:	XU5 status						
		Possible values: <table border="1"> <thead> <tr> <th>Value</th> <th>Meaning</th> </tr> </thead> <tbody> <tr> <td>0</td> <td>Not ready</td> </tr> <tr> <td>1</td> <td>Ready</td> </tr> </tbody> </table>		Value	Meaning	0	Not ready	1	Ready
Value	Meaning								
0	Not ready								
1	Ready								
P748	CANopen status	Array [-01]:	Displays the system bus status						

5 Error monitoring and error messages

The frequency inverters are equipped with monitoring functions and generate error messages in case of deviations from the normal operating state.

5.1 Bus operation monitoring function

Regardless of bus-specific watchdogs, a wide range of monitoring functions are integrated in the frequency inverter. With the aid of this "Timeout" monitoring, communication problems are detected, which are either related to general functionalities ("No bus communication") or are related to special components ("Failure of a participant").

Communication failures in the NORD system bus are registered in the frequency inverter and result in specific error messages.

Function	Parameters
Set option monitoring	P120
Set telegram downtime (timeout)	P513
Display field bus status	P872
Display of frequency inverter errors	P700

Information

The setting ("Off" = No error) of parameter **P513 Telegram timeout time** [-03] und [-04] ensures that the frequency inverter ignores all communication errors on both the field bus and the system bus level. The frequency inverter maintains its operating status.

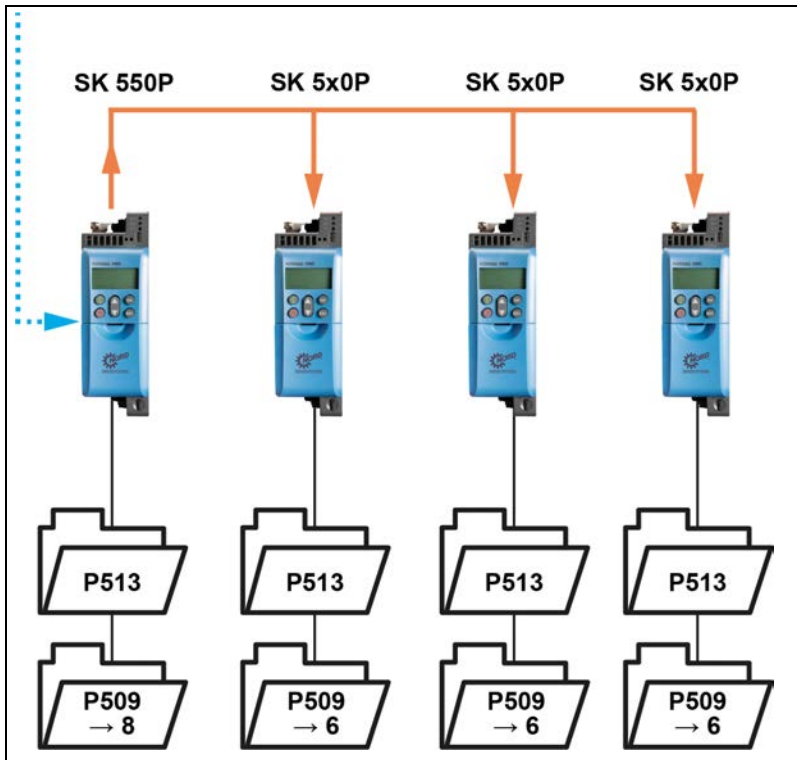

Figure 17: Example of monitoring parameter settings

Setting values for parameter **P509 setpoint source**:

- 6 = CANopen
- 8 = Ethernet

5.2 Resetting error messages

There are several methods for resetting (acknowledging) an error message.

- Switch the mains voltage off and on again, or
- Activate the **digital inputs** programmed via parameter **P420** with the setting 12 = "Acknowledge fault", or
- Switch off "Enable" on the frequency inverter (if no digital input is parameterised to the function "Acknowledge errors"), or
- Perform a bus acknowledgement, or
- Automatic error acknowledgement by activating parameter **P506 Auto. Acknowledge Error**.

5.3 Error messages – general communication errors

Error messages which occur in relation to the field bus interface are depicted with parameters **P700** and **P701**.

Error number (P700 [-01])	DS402: Extended error number (P700 [-04])	Error description
10.0	0x7580	CAN /CANopen connection error
10.0	0x7581	CAN Broadcast telegram timeout
10.0	0x7582	CANopen NodeGuard telegram timeout
10.0	0x7583	CANopen HeartBeat monitoring telegram timeout
10.0	0x7584	USS telegram timeout
10.0	0x7585	CAN in Bus Off state
10.0	0x7586	USB telegram timeout
10.0	0x7587	Ini CAN Hardware Problem
10.1	0x7590	Reserve
10.2	0x7591	Telegram timeout for field bus interface (Time-out through PLC)
10.3	0x7592	Telegram timeout for field bus interface (Time-out through P513)
10.4	0x7593	External bus module initialisation failure
10.5	0x7594	External Bus module system failure
10.5	0x7595	System error; netX and controller not compatible
10.5	0x7596	Error when changing the field bus protocol
10.5	0x7597	System errors: Package to field bus interface too long
10.5	0x7598	Condition for change of field bus protocol not present
10.6	0x7599	Ethernet cable not connected
10.7	0x759A	Reserve
10.8	0x759B	Communication error to field bus interface

5.4 Troubleshooting – Industrial Ethernet

5.4.1 POWERLINK

If the module monitoring is switched on, the PLC continuously monitors the connection to the participants in the fieldbus system (CN). If the connection is interrupted by an error in the CN, the PLC stops and changes to Service Mode.

Possible reasons for interruption of the connection:

- The frequency inverter triggers an error and parameter `<v>T - P163/P857</v>` **FI sets bus error** is set to "1" (factory setting)
- The bus load is too high

If the module monitoring is switched off in the PLC, the PLC remains in RUN mode, even in case of a CN error and no error is generated in the PLC logger. However, the PLC attempts to restore communication with the CN.

For the PLC to monitor the POWERLINK connection and not to change to Service Mode in case of a frequency inverter error, parameter `<v>T - P163/P857</v>` can be set to "False" in the PLC project. To then detect a frequency inverter malfunction, the Bit 3 "Fault" and the Bit 1 "Ready for operation" in the status word must be monitored.

5.4.1.1 Error monitoring via the frequency inverter

Faults can be detected by monitoring Bit 3 "Fault" in the status word of the process data. If a fault occurs in the frequency inverter, this flag is set and the cause of the fault can be determined with parameter `P700` or the frequency inverter object (e.g. "3000h" + "700" = "32BC").

5.4.1.2 Error monitoring via POWERLINK

If a fault occurs in the frequency inverter, the CN generates an error entry in object "1003h" = "ERR_History_ADOM". In addition, errors are transmitted to the Managing Node via the "Emergency Queue", if the Managing Node supports this function.

The error message has the following structure:

Byte 0	Byte 1	Byte 2	Byte 3	Byte 4	Byte 5	Byte 6...13
Entry Type	Error code		Time stamp		FI-ID ¹ (ASCII)	FI Error Code (ASCII)

¹ The FI ID identifies the frequency inverter in which the error occurred (FI1 = 1, FI2 = 2, etc.)

For detailed information about the object  POWERLINK specification DS-301.

Error Groups

The CANopen communication profile DS-301, which is used by POWERLINK ("CANopen over POWERLINK" protocol), defines the following error groups:

Error code	Meaning
00xxh	No error
10xxh	Undefined error type
20xxh	Current error
30xxh	Voltage error
40xxh	Temperature error
50xxh	Hardware error
60xxh	Software error
70xxh	Additional module
80xxh	Communication
90xxh	External error
FF00h	Specific to device

Allocation of frequency inverter error codes

Error code	Error index	Frequency inverter (P700)*	
		Error code	Meaning
1000h	0	0	No error
1000h	1	—	The error number must be read out via parameter P700 or an actual value.
2200h	3	4.0/4.1	Overcurrent frequency inverter/current measurement
2310h	3	3.0	Overcurrent I ² t-limit
2311h	3	3.2	IGBT overcurrent 125 %
2312h	3	3.3	IGBT overcurrent 150 %
3110h	5	5.1	Mains voltage too high
3120h	5	6.1	Mains voltage too low
3130h	5	7.0	Mains connection failure
3210h	5	5.0	Link circuit voltage too high
3230h	5	6.0	Link circuit voltage too low
4210h	9	1.1	Overtemperature in frequency inverter
4310h	9	2.0/2.1/2.2	Motor overtemperature
5000h	1	10.8	Bus interface communication error
5110h	1	11.0	External bus error
5300h	1	17.0	EMC fault
5510h	1	20.0	Reserved
5520h	1	20.8	EEPROM error
5530h	1	8.2	External copy error
6000h	1	15.0...15.8/ 20.1...20.7/21.3	System error
6310h	1	8.0	Parameter loss (maximum EEPROM value exceeded)
7112h	3	3.1	Brake chopper overcurrent
7120h	1	16.0/16.1	Motor error

Error code	Error index	Frequency inverter (P700)*	
		Error code	Meaning
7300h	1	14.3	Absolute encoder error
7305h	1	13.0	Encoder error
7306h	1	14.4	Absolute encoder error
7310h	1	14.5	Position difference
7320h	1	14.6...14.8	Position error
7330h	1	25.0	Position deviation
7331h	1	25.1	Universal encoder communication error
7332h	1	25.2	
7333h	1	25.3	Universal encoder error
7334h	1	25.4	
8100h	17	10.0...10.2	Bus timeout
8111h	17	10.3...10.7/10.9	Bus interface communication error
8300h	1	13.2	Slip error switch-off monitoring
8400h	1	13.1	Speed slip error
8600h	1	14.0...14.1	Reference point error
8612h	1	14.2	
8710h	1	13.5	Acceleration path error
8711h	1	13.6	
9000h	1	12.0...12.2	External watchdog
FF10h	129	18.0	Reserved
FF11h	129	19.0	Connected motor not identified

* For a detailed description of the error code  frequency inverter manual.

5.4.2 PROFINET IO

If an error occurs in the frequency inverters which are connected to the NORD system bus, the frequency inverter which is connected to the PROFINET IO sends a diagnostic alarm as "incoming event" to the IO controller. The error value is coded as follows:

Error number (value from P700) + 100 h = Alarm number of the diagnostic alarm

Example:

Error E10.3 "Timeout by P872/P513" occurs during operation (**P700**, Index 1 = 103). The frequency inverter sends a diagnostic alarm with the value "359" ($100h + 103 = 256 + 103 = 359$) to the IO controller.

Format	Error number	Alarm code	Alarm number
Decimal	10.3 = 103	256	$103 + 256 = 359$
Hexadecimal	67h	100h	167h

If an error has been remedied or acknowledged, a diagnostic alarm is sent as a "outgoing event", which resets the error in the IO controller.

Information

If the connection with one of the frequency inverters which are connected to the NORD system bus is lost, an alarm with the error number "1000" is sent to the diagnostic buffer of the IO controller ($256 + 1000 = 1256$).

5.5 LEDs

The frequency inverter is equipped with several dual colour LEDs (red and green) for diagnostic purposes.

- The device-specific LEDs **(1)** are labelled as "DEV" and "BUS".
- The two status LEDs **A** and **B** **(2)**, which are significant for communication in Industrial Ethernet are not directly labelled.

Explanations for the individual LEDs are described below.



Figure 18: LEDs – status displays on the device

5.5.1 Device-specific LEDs

5.5.1.1 "DEV" LED

The LED labelled **"DEV"** indicates the general device status.

Status	Meaning
Off	<ul style="list-style-type: none"> FI not ready for operation, no mains or control voltage
Lights up green	<ul style="list-style-type: none"> FI is enabled
Flashing green (4 Hz)	<ul style="list-style-type: none"> FI is in switch-on block
Flashing green (0.5 Hz)	<ul style="list-style-type: none"> FI is in standby but not enabled
Flashing green and red alternately (4 Hz)	<ul style="list-style-type: none"> Warning
Flashing red (2 Hz/ 1 Hz)	<ul style="list-style-type: none"> Output of the error number (e.g. Error 3: flashes three times and then pauses)
Flashing green and red	<ul style="list-style-type: none"> FI in Update mode
Flashing green and red simultaneously	<ul style="list-style-type: none"> Update data are communicated

5.5.1.2 "BUS" LED

The LED labelled **"BUS"** indicates the status of communication at the system bus level.

Status	Meaning
Off	<ul style="list-style-type: none"> No process data communication
Lights up green	<ul style="list-style-type: none"> Process data communication active
Flashing green (4 Hz)	<ul style="list-style-type: none"> Bus warning
Flashing green (0.5 Hz)	<ul style="list-style-type: none"> FI is in standby but not enabled
Flashing red (4 Hz)	<ul style="list-style-type: none"> Monitoring error P120 or P513 (E10.0/E10.9)
Flashing red (1 Hz)	<ul style="list-style-type: none"> Field bus interface telegram timeout (E10.2/E10.3)
Lights up red	<ul style="list-style-type: none"> System bus in state "Bus off"

5.5.2 Industrial Ethernet status LEDs

These LEDs indicate the status of communication in Industrial Ethernet. Depending on the selected bus protocol (**P899**) the two LEDs have different, specific meanings.

5.5.2.1 EtherCAT

LED A

LED **A** is labelled "RUN" and indicates the "Ethernet State".

Status	Meaning
Off	State <i>Init</i> <ul style="list-style-type: none"> No communication of process data and parameters
Flashing green	State <i>Pre-Operational</i> <ul style="list-style-type: none"> Parameter communication active No process data communication
Single green flash	State <i>Safe Operational</i> <ul style="list-style-type: none"> Parameter communication active Restricted process data communication No restrictions to actual values Setpoints not evaluated
Lights up green	State <i>Operational</i> <ul style="list-style-type: none"> Parameter communication active Process data communication active

LED B

LED **B** is labelled "ERR" and indicates the "Ethernet Error".

Status	Meaning
Off	State <i>No Error</i> <ul style="list-style-type: none"> EtherCAT functioning normally on the frequency inverter
Flashing red	State <i>Invalid Configuration</i> <ul style="list-style-type: none"> General EtherCAT configuration error, may be generated because of an incorrect XML file
Single red flash	State <i>Unsolicited State Change</i> <ul style="list-style-type: none"> Frequency inverter has changed the EtherCAT state without authorisation
Double red flash	State <i>Application Watchdog Timeout</i> <ul style="list-style-type: none"> EtherCAT or FI timeout (P513 or P151)

5.5.2.2 Ethernet/IP

LED A

LED **A** is labelled "MS" and indicates the "Module State".

Status	Meaning
Off	<ul style="list-style-type: none"> No operating voltage
Flashing green	<ul style="list-style-type: none"> Bus interface not configured in FI
Lights up green	<ul style="list-style-type: none"> Bus interface in FI working correctly
Flashing red	<ul style="list-style-type: none"> Insignificant error Incorrect configuration
Lights up red	<ul style="list-style-type: none"> Error cannot be corrected
Flashing green and red	<ul style="list-style-type: none"> Power up, self test

LED B

LED **B** is labelled "NS" and indicates the "Network State".

Status	Meaning
Off	<ul style="list-style-type: none"> No operating voltage
Flashing green	<ul style="list-style-type: none"> IP address configured but no CIP connection available
Lights up green	<ul style="list-style-type: none"> CIP connection(s) available
Flashing red	<ul style="list-style-type: none"> Time-out, an "exclusive owner connection" has a time-out error
Lights up red	<ul style="list-style-type: none"> Dual IP. The IP address is already being used by the bus interface
Flashing green and red	<ul style="list-style-type: none"> Power up, self test

5.5.2.3 POWERLINK

LED A

LED A is labelled "BS" and indicates the "Module State".

Status	Meaning
Off	<ul style="list-style-type: none"> No communication
Flashing green (1x)	State <i>Pre-Operational 1</i> <ul style="list-style-type: none"> Parameter communication active No process data communication
Flashing green (2x)	State <i>Pre-Operational 2</i> <ul style="list-style-type: none"> As for Pre-Operational 1
Flashing green (3x)	State <i>Ready To Operate</i> <ul style="list-style-type: none"> Parameter communication active Restricted process data communication
Lights up green	State: <i>Operational</i> <ul style="list-style-type: none"> Parameter communication active Process data communication active
Flashing green (10 Hz)	State: <i>Basic Ethernet</i> <ul style="list-style-type: none"> Parameter communication via UDP No process data communication
Flashing green (2.5 Hz)	State: <i>Stopped</i> <ul style="list-style-type: none"> No communication

LED B

LED B is labelled "BE" and indicates the "Network Error".

Status	Meaning
Off	<ul style="list-style-type: none"> No POWERLINK error
Lights up red	<ul style="list-style-type: none"> General POWERLINK error

5.5.2.4 PROFINET IO

LED **A** is labelled "BF" and indicates the "Ethernet Error".

LED **B** is labelled "RUN" and indicates the "Ethernet State".

Status		Meaning
LED A	LED B	
Off	Off	<ul style="list-style-type: none"> • FI is switched off • Ethernet connection to control system present (AR established) • Alarm acknowledged
Off	Lights up green	<ul style="list-style-type: none"> • No Ethernet connection <ul style="list-style-type: none"> – Switch on the frequency inverter – Pull out the Ethernet plug and plug in again
Off	Flashing green	<ul style="list-style-type: none"> • AR not present or lost <ul style="list-style-type: none"> – Plug in the Ethernet plug (Port 1 or Port 2) and establish connection to the switch
Lights up red	Off	<ul style="list-style-type: none"> • Alarm

6 Additional information

6.1 Data transmission

6.1.1 Introduction

With the data communication process data and parameter data are exchanged between the frequency inverter and the bus master (PLC).

6.1.1.1 Process data

- Process data are the control word and up to 5 setpoints, as well as the status word and up to 5 actual values. Control words and setpoints are communicated from the bus master to the frequency inverters. Status words and actual values are communicated from the frequency inverters to the bus master.
- Process data are necessary to control the frequency inverter.
- The transfer of process data is carried out cyclically with priority between the bus master and the frequency inverters.
- In the PLC the process data are stored directly in the I/O area.
- Process data are not saved in the frequency inverter.

 Section 2.5.5.1 "Process data telegrams".

6.1.1.2 Parameter data



- Parameter data are the setting values and device data for the frequency inverter.
- Transfer of the parameter data is carried out acyclically without priority.
- If PPO types 1 and 2 are used ( Section 2.5.5.1 "Process data telegrams") the parameters can be transferred cyclically.

 Section 2.5.6 "Parameter data transmission".

6.1.2 Transfer of process data

6.1.2.1 Control word

The control word (STW) is the first word of a process data telegram which is sent from the bus master to the frequency inverter (order telegram) To switch the drive unit to standby, the frequency inverter must be set to "Ready for switch-on" status by transfer of the first control command "047Eh" ("10001111110b").

Bit	Designation	Value	Control command	Priority ¹															
0	Ready for operation	0	Reverse with brake ramp, with voltage enabled at f=0 Hz (ready for operation)	3															
		1	Set the frequency inverter to standby.	5															
1	Disable voltage	0	Switch off the frequency inverter output voltage (the frequency inverter goes into the status "Switch-on block").	1															
		1	Cancel "Disable voltage"	—															
2	Emergency stop	0	Emergency stop with programmed emergency stop time. At f = 0 Hz voltage enable (the FI goes into "Switch-on block" status)	2															
		1	Cancel operating condition "Emergency stop"	—															
3	Enable operation	0	Block voltage: Switch off the frequency inverter output voltage (the frequency inverter goes into the status "Ready for switch-on").	6															
		1	Enable output voltage Acceleration of the frequency inverter to the present setpoint.	4															
4	Enable pulses	0	Acceleration encoder is set to zero; at f = 0 Hz no voltage enable (FI remains in "Operation enabled" status).	—															
		1	Enable acceleration encoder	—															
5	Enable ramp	0	Freeze the setpoint currently provided by the acceleration encoder (maintain frequency).	—															
		1	Enable setpoint on acceleration encoder	—															
6	Enable setpoint	0	Set the selected setpoint on the acceleration encoder to 0	—															
		1	Activate the selected setpoint on the acceleration encoder.	—															
7	Acknowledge the error (0→1)	0	With the switch from 0 to 1, inactive errors are acknowledged.	7															
		1	Note: If a digital input has been programmed for the "ack.fault" function, this bit must not permanently be set to 1 via the bus, as otherwise, flank evaluation would be prevented.																
8	Start function 480.11	0		—															
		1	Bus bit 8 of the control word is set  Parameter P480 in the frequency inverter manual.																
9	Start function 480.12	0		—															
		1	Bus bit 9 of the control word is set  Parameter P480 in the frequency inverter manual.																
10 ²	Control data valid	0	The transmitted process data are invalid.	—															
		1	The bus master transfers valid process data																
11 ³	Rotation right is on	0		—															
		1	Switch on rotation right.																
12 ³	Rotation left is on	0		—															
		1	Switch on rotation left (priority).																
13	Reserved																		
14	Parameter set Bit 0 On	0	<table border="1" style="display: inline-table; vertical-align: middle;"> <thead> <tr> <th>Bit 15</th> <th>Bit 14</th> <th>it activates the parameter set</th> </tr> </thead> <tbody> <tr> <td>0</td> <td>0</td> <td>Parameter set 1</td> </tr> <tr> <td>0</td> <td>1</td> <td>Parameter set 2</td> </tr> <tr> <td>1</td> <td>0</td> <td>Parameter set 3</td> </tr> <tr> <td>1</td> <td>1</td> <td>Parameter set 4</td> </tr> </tbody> </table>	Bit 15	Bit 14	it activates the parameter set	0	0	Parameter set 1	0	1	Parameter set 2	1	0	Parameter set 3	1	1	Parameter set 4	—
		Bit 15		Bit 14	it activates the parameter set														
0	0	Parameter set 1																	
0	1	Parameter set 2																	
1	0	Parameter set 3																	
1	1	Parameter set 4																	
1																			
15	Parameter set Bit 1 On	0		—															
		1																	

¹ If several control bits are set simultaneously, the priority stated in this column applies.



² The telegram is only interpreted as valid by the frequency inverter and the setpoints which are communicated via the field bus are only set if control bit 10 is set to 1.

³ If Bit 12 = 0, "rotational direction right ON" applies.

If Bit 12 = 1, "rotational direction left ON" applies, irrespective of Bit 11.

6.1.2.2 Status word

The status word (ZSW) is the first word of a process data telegram which is sent from the frequency inverter to the bus master (response telegram). With the status word, the status of the frequency inverter is reported to the bus master. As the response to the control word command "047Eh" the frequency inverter typically responds with "0B31h" ("101100110001b") and therefore indicates the status "Ready for switch-on".

Bit	Meaning	Value	Status message															
0	Ready to start	0																
		1	Initialisation completed, charging relay switched on, output voltage disabled															
1	Ready for operation	0	No switch-on command present, or there is a fault, of the command "Disable voltage" or "Emergency stop" is present, or the status is "Switch-on block".															
		1	There is a switch-on command and there is no fault. The inverter can be started with the command "Enable operation"															
2	Operation enabled	0																
		1	The output voltage is enabled; ramp of the frequency inverter up to the existing setpoint															
3	Fault	0																
		1	Drive unit defective and therefore "Not ready for operation". After acknowledgement, the frequency goes into status "Switch-on block".															
4	Voltage enabled	0	"Disable voltage" command present.															
		1																
5	Emergency stop	0	"Emergency stop" command present.															
		1																
6	Starting disabled	0																
		1	With the command "Standby" the frequency goes into status "Ready for switch-on".															
7	Warning active	0																
		1	Drive operation continues, no acknowledgement necessary															
8	Setpoint reached	0	Actual value does not correspond to the setpoint With use of POSICON: Setpoint position not reached.															
		1	Actual value matches the setpoint (setpoint reached) With use of POSICON: setpoint position has been reached															
9	Bus control active	0	Control on local device active															
		1	The master has been requested to take over control.															
10	Start function 481.9	0																
		1	Bus bit 10 of the status word is set  Parameter P481 in the frequency inverter manual.															
11	Rotation right is on	0																
		1	The frequency inverter output voltage has a right-hand rotation field.															
12	Rotation left is on	0																
		1	The frequency inverter output voltage has a left-hand rotation field.															
13	Start function 481.10	0																
		1	Bus bit 13 of the status word is set  Parameter P481 in the frequency inverter manual.															
14	Parameter set Bit 0 ON	0	<table border="1"> <thead> <tr> <th>Bit 15</th> <th>Bit 14</th> <th>parameter set, that is active</th> </tr> </thead> <tbody> <tr> <td>0</td> <td>0</td> <td>Parameter set 1</td> </tr> <tr> <td>0</td> <td>1</td> <td>Parameter set 2</td> </tr> <tr> <td>1</td> <td>0</td> <td>Parameter set 3</td> </tr> <tr> <td>1</td> <td>1</td> <td>Parameter set 4</td> </tr> </tbody> </table>	Bit 15	Bit 14	parameter set, that is active	0	0	Parameter set 1	0	1	Parameter set 2	1	0	Parameter set 3	1	1	Parameter set 4
		Bit 15		Bit 14	parameter set, that is active													
0	0	Parameter set 1																
0	1	Parameter set 2																
1	0	Parameter set 3																
1	1	Parameter set 4																
1																		
15	Parameter set Bit 1 On	0																
		1																

6.1.2.3 Frequency inverter status machine

The frequency inverter passes through a status machine. The changes between various states are triggered automatically or by control commands in the process data control word. The present status is returned in the process data status word.

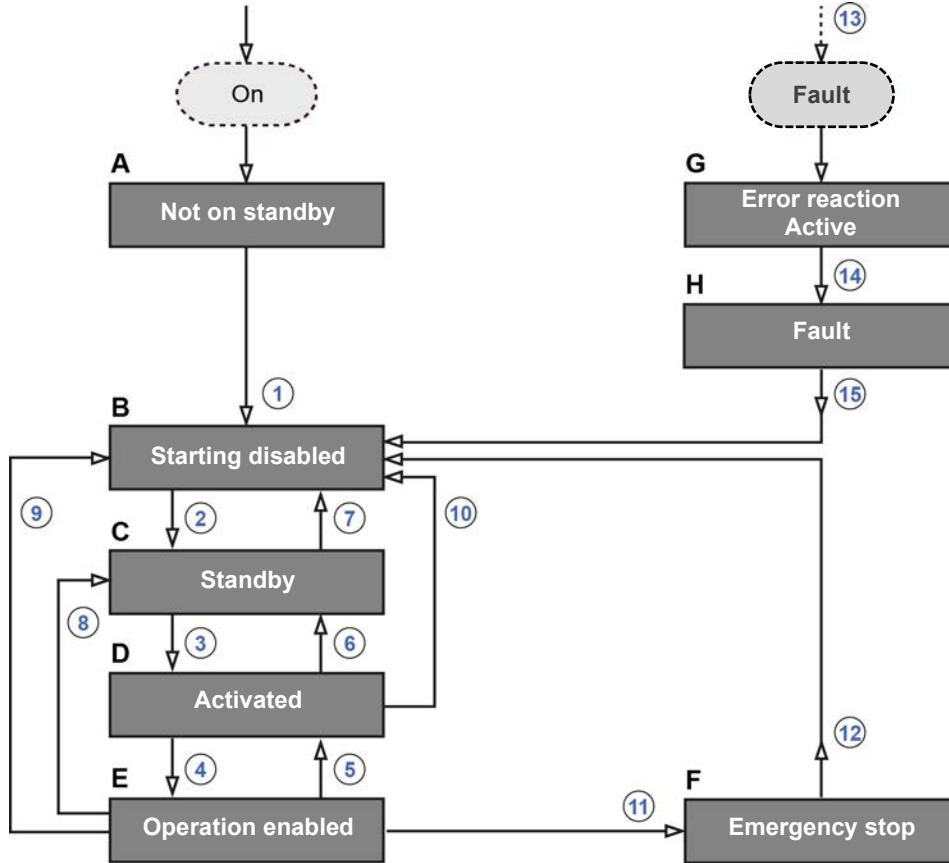

Figure 19: Frequency inverter status machine

Item	Meaning
A...H	Frequency inverter statuses (Table "Frequency inverter statuses")
1...15	Status transitions (Table "Status transitions")

Frequency inverter statuses

Status		Description
A	Not on standby	Initial state after switching on the frequency inverter. As soon as the loading relay engages, the frequency inverter automatically changes to the status "Switch-on block".
B	Switch-on block	Second status after switching on the frequency inverter, which can only be exited with the control command "Shut-down". The charging relay is switched on.
C	Standby	In this status, initialisation of the frequency inverter is complete. The output voltage is blocked.
		<p>i Information</p> <p>During the initialisation process the response to a bus master telegram does not yet contain the response to the control command which has been issued. On the basis of the response from the bus participant, the control system must determine whether the control command has been executed.</p>
D	Activated	Frequency inverter ready for operation.
E	Operation enabled	The frequency inverter receives and processes setpoints.
F	Emergency stop active	Emergency stop function is being executed (the drive is stopped), the frequency inverter changes to the status "Switch-on block".
G	Error reaction active	If an error occurs, the frequency inverter changes to this status and all functions are blocked.
H	Fault	After processing of the response to the fault, the frequency inverter changes to this status, which can only be exited with the control command "Acknowledge fault".

Status transitions

Triggered status transition		Control command	Bit 7...0 of the control word ¹								
			7	6	5	4	3	2	1	0	
1	From "Not ready for switch-on" to "Switch on block"	—	—								
	Automatic activation of the charging relay										
2	From "Switch-on block" to "Ready for switch-on"	Shut down	X	X	X	X	X	1	1	0	
3	From "Ready for switch-on" to "Switched on"	Switch on	X	X	X	X	X	1	1	1	
4	From "Switched on" to "Operation enabled"	Enable operation	X	1	1	1	1	1	1	1	
	Output voltage is enabled										
5	From "Operation enabled" to "Switched on"	Disable operation	X	X	X	X	0	1	1	1	
	Output voltage is disabled										
6	From "Switched on" to "Ready for switch-on"	Shut down	X	X	X	X	X	1	1	0	
	Voltage enabled at "f = 0 Hz"										
7	From "Ready for switch-on" to "Switch-on block"	Disable voltage	X	X	X	X	X	X	0	X	
		Quick stop	X	X	X	X	X	0	1	X	
8	From "Operation enabled" to "Ready for switch-on"	Shut down	X	X	X	X	X	1	1	0	
9	From "Operation enabled" to "Switch on block"	Disable voltage	X	X	X	X	X	X	0	X	
10	From "Switched on" to "Switch on block"	Disable voltage	X	X	X	X	X	X	0	X	
		Quick stop	X	X	X	X	X	0	1	X	
11	From "Operation enabled" to "Emergency stop active"	Quick stop	X	X	X	X	X	0	1	X	
12	From "Emergency stop active" to "Switch on block"	Disable voltage	X	X	X	X	X	X	0	X	
13	Automatically, after the occurrence of a fault from any status	—	—								
14	Automatically after completion of the response to a fault	—	—								
15	End fault	Acknowledge error	0	X	X	X	X	X	X	X	X
			→								
			1	X	X	X	X	X	X	X	X

X = The bit status (0 or 1) is not important for achieving the status. Please also note the list of control bits, [Section 6.1.2.1 "Control word"](#).

¹ Complete list of control bits (Bit 0...15) [Section 6.1.2.1 "Control word"](#).

i Information

Control bit 10

Control bit 10 "Control data valid" must always be set to 1. Otherwise the process data will not be evaluated by the frequency inverter.

Decoded frequency inverter statuses

Status	Status bit ¹						
	6	5	4	3	2	1	0
Not ready for switch-on	0	X	X	0	0	0	0
Starting disabled	1	X	X	0	0	0	0
Ready to start	0	1	1	0	0	0	1
Activated	0	1	1	0	0	1	1
Operation enabled	0	1	1	0	1	1	1
Fault	0	X	X	1	0	0	0
Error active	0	X	X	1	1	1	1
Emergency stop active	0	0	1	0	1	1	1

¹ Complete list of status bits (Bit 0...15)  Section 6.1.2.2 "Status word".

6.1.2.4 Setpoints and actual values

Setpoints (from the bus master to the frequency inverter) and actual values (from the frequency inverter to the bus master) are specified via the following parameters of the frequency inverter:

Transmission direction	Process value	Parameters
To the frequency inverter	Setpoint 1	P546, Array [-01]
	Setpoint 2	P546, Array [-02]
	Setpoint 3	P546, Array [-03]
	Setpoint 4	P546, Array [-04]
	Setpoint 5	P546, Array [-05]
From the frequency inverter	Actual value 1	P543, Array [-01]
	Actual value 2	P543, Array [-02]
	Actual value 3	P543, Array [-03]
	Actual value 4	P543, Array [-04]
	Actual value 5	P543, Array [-05]

Setpoints and actual values are transmitted by three different methods:

Percentage transmission

The process value is transmitted as an integer with a value range of -32768 to 32767 (8000 hex to 7FFF hex). The value "16384" (4000 hex) corresponds to 100 %. The value "-16384" (C000 hex) corresponds to 100%.

For frequencies, the 100% value corresponds to parameter **P105 Maximum Frequency** of the frequency inverter. For current, the 100% value corresponds to parameter **P112 Torque Current Limit** of the frequency inverter.

Frequencies and currents result from the following formulae:

$$Frequency = \frac{Value^* \times P105}{16384}$$

$$Current = \frac{Value^* \times P112}{16384}$$

* 16 Bit- setpoint or actual value which is transmitted via the bus.

Binary transmission

Inputs and outputs as well as digital input bits and bus output bits are evaluated bit-wise.

Transmission of positions

In the frequency inverter, positions have a value range of -50000.00...50000.00 rotations. A rotation of the motor can be subdivided into a maximum of 1000 increments. The subdivision depends on the encoder which is used.

The 32 Bit value range is divided into a "Low" and a "High" word, so that two setpoints or actual values are required for the transmission.

Direction of transmission	Transmitted data					
	1st word	2nd word	3rd word	4th word	5th word	6th word
To the frequency inverter	Control word	32 Bit setpoint		Setpoint 3	Setpoint 4	Setpoint 5
From the frequency inverter	Status word	Actual value 1	32 Bit actual value		Actual value 4	Actual value 5

Only the "Low" word for the position can also be transmitted. This results in a limited value range from 32,767 to -32,768 rotations. This value range can be extended with the ratio factor (**Parameter P607 Ratio** and **P608 Reduction Ratio**), however this reduces the resolution accordingly.

6.1.3 Example of setpoint specification

The following example shows the specification of a setpoint for switching a frequency inverter on and off. The frequency inverter is operated with a setpoint (setpoint frequency) and responds with an actual value (actual frequency). The maximum frequency is set to 50 Hz.

Parameter settings on the frequency inverter:

Parameter No.	Parameter name	Setting value
P105	Maximum frequency	50 Hz
P543	Actual bus value 1	1 (= Actual frequency)
P546	Function bus setpoint 1	1 (= Setpoint frequency)

Example

Order to FI		Response from the FI		Remarks
Control word	Setpoint 1	Status word	Actual value 1	
—	—	0000h	0000h	
—	—	xx40h	0000h	The mains voltage is switched on at the frequency inverter
047Eh	0000h	xx31h	0000h	The frequency inverter switches to "Ready for switch-on" status
047Fh	2000h	xx37h	2000h	The frequency inverter is set to "Operation enabled" status and controlled with a 50 % setpoint.
The frequency inverter is enabled, the motor is supplied with current and rotates with a frequency of 25 Hz.				
0047Eh	2000h	xx31h	0000h	The frequency inverter switches to "Ready for switch-on" status The motor brakes to a standstill according to the parameterised ramp and is disconnected from the power supply.
The frequency inverter is blocked again and the motor is without current.				
047Fh	1000h	xx37h	1000h	The frequency inverter is set to "Operation enabled" status and controlled with a 25% setpoint.
The frequency inverter is enabled, the motor is supplied with current and rotates with a frequency of 12.5 Hz.				

6.2 Topology overview

Depending on the field bus protocol which is used, an Industrial Ethernet can be set up in various ways. Bus-specific special features or prerequisites are described in  Section 2 "Basics".

6.2.1 Linear topology

Linear topology connects field bus participants which are equipped with integrated switches. An HMI can be optionally integrated.

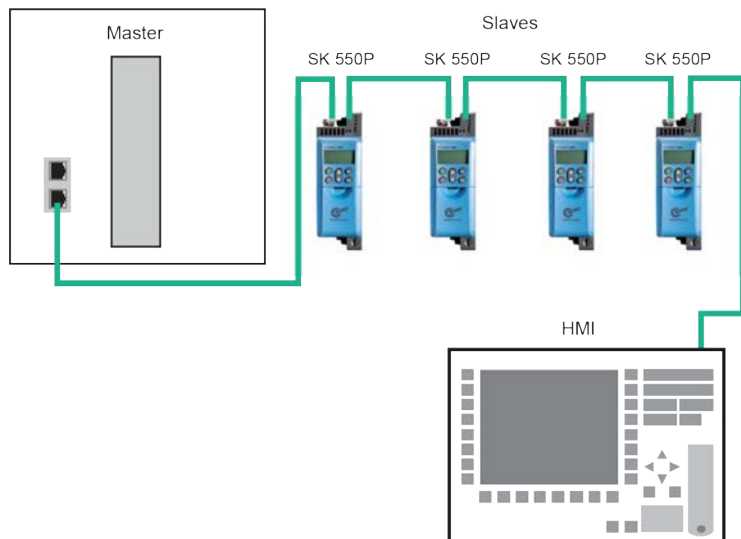

Figure 20: Linear topology (example)

Advantages: Requires little cable material, can be extended at the end of the line with little effort.

Disadvantages: If the line is interrupted (device failure or defective cable) the downstream field bus participants can no longer be accessed.

6.2.2 Star topology

The star topology requires a central switch (in the control cabinet). An HMI can be optionally integrated.

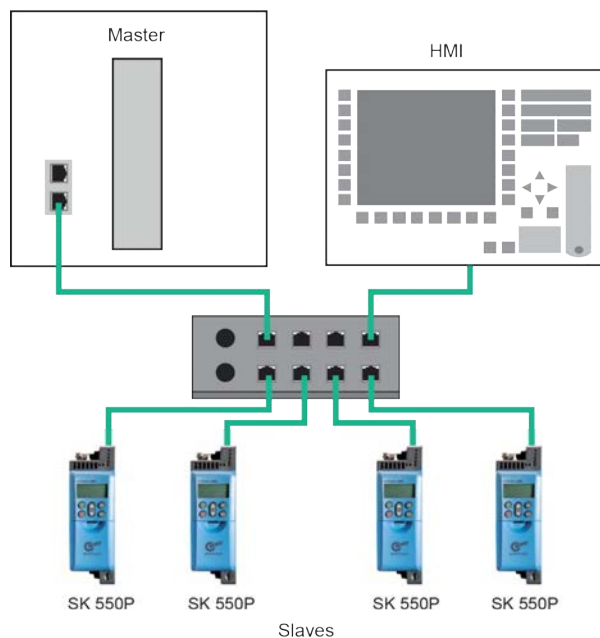

Figure 21: Star topology (example)

Advantages: A device failure has no effect on the other bus participants; can be extended with little effort, simple troubleshooting.

Disadvantages: Operation of the network is not possible in case of problems with the switch.

6.2.3 Ring topology

With a ring topology, one line is closed to form a ring for media redundancy. An HMI can be optionally integrated.

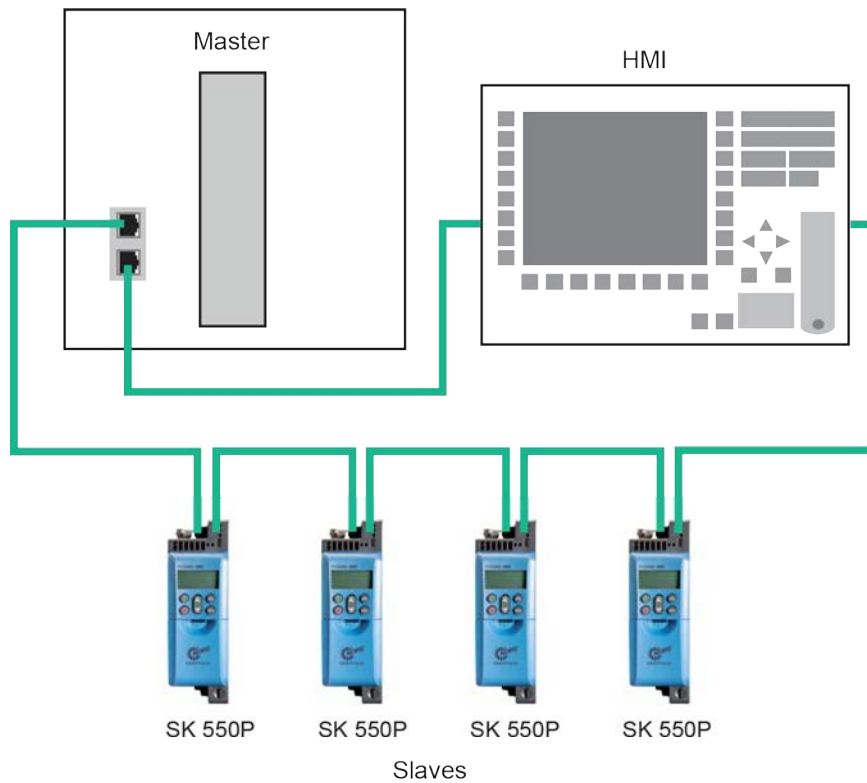

Figure 22: Ring topology (example)

Advantages: Communication continues even if one cable is defective.

Disadvantages: High load states result in bottlenecks.

6.2.4 Tree topology

In a tree topology, linear and star topologies can be mixed. An HMI can be optionally integrated.

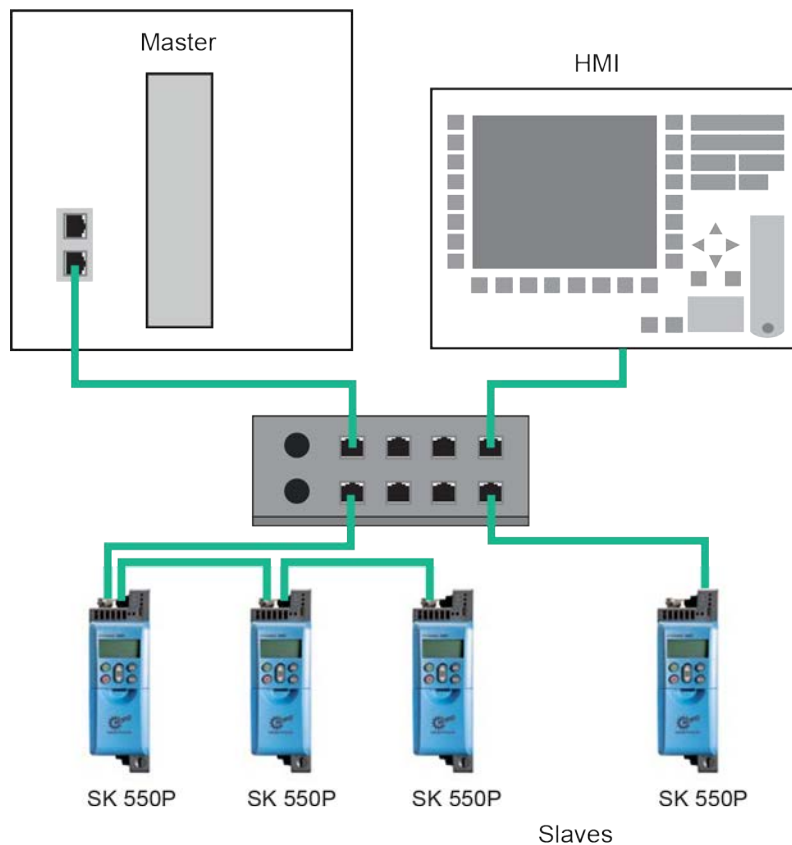

Figure 23: Tree topology (example)

Advantages: Combines the advantages of linear and star topologies, can be easily expanded, simple troubleshooting.

Disadvantages: Operation of the network is not possible in case of problems with the switch.

7 Appendix

7.1 Service notes

Our Technical Support is available in case of technical queries.

If you contact our technical support, please have the precise device type (type plate/display), accessories and/or options, the software version used (P707) and the series number (type plate) at hand.

The device must be sent to the following address if it needs repairing:

NORD Electronic DRIVESYSTEMS GmbH
 Tjüchkampstraße 37
 D-26605 Aurich, Germany

Please remove all non-original parts from the device.

No guarantee is given for any attached parts such as power cables, switches or external displays.

Please back up the parameter settings before sending in the device.

Information

Please note the reason for sending in the component/device and specify a contact for any queries that we might have.

You can obtain a return note from our web site ([Link](#)) or from our technical support.

Unless otherwise agreed, the device is reset to the factory settings after inspection or repair.

Information

In order to rule out the possibility that the cause of a device fault is due to an optional module, the connected optional modules should also be returned in case of a fault.

Contacts (Phone)

Technical support	During normal business hours	+49 (0) 4532-289-2125
	Outside normal business hours	+49 (0) 180-500-6184
Repair inquiries	During normal business hours	+49 (0) 4532-289-2115

The manual and additional information can be found on the Internet under www.nord.com.

7.2 Documents and software

Documents and software can be downloaded from our website www.nord.com.

Other applicable documents and further information

documentation	Contents
BU_0600	Manual for frequency inverter NORDAC <i>PRO SK 500P</i>
BU_0000	Manual for use of NORDCON software

Software

Software	Description
Device description files	Device description file for configuration software in Industrial Ethernet
NORDCON	Parameterisation and diagnostic software

Key word index

A

Active Assembly (P879)	86
Actual value	
IW	19, 48
Actual values	112
Additional parameters	90
Address	119
Addressing Mode (P856)	79
Addressing the frequency inverter	71

B

Binary transmission	112
Bus node	15
Bus Node	61
Bus protocol	18
Bus status (P872)	84

C

CAN Address (P515)	15, 61
CAN Baud Rate (P514)	15
CAN Bus Baud Rate (P514)	62
CAN over EtherCAT (CoE)	20
CAN-ID	15, 61
CANopen	14
Changing the bus protocol (P899)	76
Client/Server principle	26
Commissioning	65, 67, 69, 71, 73
Connection	
Field bus	63
System bus	61
Contact	119
Control bit	106
Control word	106, 110
CTW	48
STW	19

D

Data record transfer	
Examples	58
Data records	

Format	53, 54
Parameter orders	53
Data transmission	105
Device characteristics	64
Device description file	19, 48, 64, 65, 67, 69, 71
Device detection	65, 67, 69
Device Name (P854)	80, 83
Documents	
Other applicable	120

E

Error messages	92
Frequency inverters	94
General communication errors	94
Reset	93
Error monitoring	92
EtherCAT	
characteristics	17
parameter (CoE directory)	20
telegram	18

F

Field bus address	65, 67, 68, 69, 70
-------------------------	--------------------

H

Hot-Connect function	18, 68
----------------------------	--------

I

I/O Connections	25
Information parameter	91
Internet	119
IO	
controller	39
device	39
supervisor	39
IP address (P850)	78, 82
IP Address (P878)	86, 87, 88
IP Gateway (P852)	78, 80, 83
IP Sub-net mask (P851)	78, 82

L

LED	99
-----------	----

M		Present IP gateway (P877).....	87, 88
Monitoring functions	92	Present IP sub-net mask (P867).....	86, 87, 88
N		Process data	73, 105
NMT status machine.....	18, 33	Process data Bus In (P873).....	84
Node ID (P850).....	80	Process data Bus out (P874).....	85
NORD		Process data telegram	19
Parameter numbers	20	Process data telegrams	47, 49, 105
System bus	14	PROFIBUS profile.....	48
NORDCON computer	14	R	
O		Records.....	52
Order label	55	Remote maintenance.....	16
OSI layer model.....	22, 28	Repairs.....	119
P		Response label	55
Parameter		Right TCP Ethernet (P853).....	79, 80
index.....	57	S	
numbers	53, 54	SDO error codes	21
order	52	Second Address.....	68
response	52	Second Address (P850).....	77
Parameter data	105	Service	119
Parameter data transmission....	49, 50, 51, 105	Setpoint	
parameter value PWE2		SW	19, 48
Error messages.....	56	Setpoint specification	
Parameterisation		Example	114
PPO1 or PPO2.....	60	Setpoints	112
Parameters	75, 90	Setting the field bus protocol	64
Data transmission	20, 26, 36	Software	120
Settings	90	Status bit	107
Percentage transmission	112	Status machine	
Permissible writing cycles.....	51	Frequency inverter	108
PKW area	53, 54	Status word	107, 111
POWERLINK cycle (P858).....	81	STW.....	48
PPO type	48	ZSW.....	19
PPO1.....	49	Support	119
PPO2.....	50	T	
PPO3.....	49	Telegram timeout (P513)	92
PPO4.....	49	Terminating resistor	62
PPO6.....	49	Timeout	92
PPO Type (P879)	89	Topology	17, 23, 29, 40
Present bus protocol (P870).....	84	Linear	115
Present IP address (P875)	86, 87, 88	Ring	117



Star.....	116	Transmission of positions	113
Tree.....	118	Troubleshooting	
Transfer of process data.....	19, 48, 51, 73, 106	Industrial Ethernet	69, 95

NORD DRIVESYSTEMS Group

Headquarters and Technology Centre
in Bargteheide, close to Hamburg

Innovative drive solutions
for more than 100 branches of industry

Mechanical products
parallel shaft, helical gear, bevel gear and worm gear units

Electrical products
IE2/IE3/IE4 motors

Electronic products
centralised and decentralised frequency inverters,
motor starters and field distribution systems

7 state-of-the-art production plants
for all drive components

Subsidiaries and sales partners
in 98 countries on 5 continents
provide local stocks, assembly, production,
technical support and customer service

More than 4,000 employees throughout the world
create customer oriented solutions

www.nord.com/locator

Headquarters:

Getriebebau NORD GmbH & Co. KG

Getriebebau-Nord-Straße 1
22941 Bargteheide, Germany

T: +49 (0) 4532 / 289-0

F: +49 (0) 4532 / 289-22 53

info@nord.com, www.nord.com

Member of the NORD DRIVESYSTEMS Group

