

EN
Explosion Protection
G2122



Contents

INDRODUCTION	A 2
COUNTRY-SPECIFIC EXPLANATIONS	A 2 - 14
GENERAL DUST EXPLOSION PROTECTION	B 1 - 8
MOTORS FOR DUST EXPLOSION PROTECTION	C 1 - 26
GENERAL GAS EXPLOSION PROTECTION	D 1 - 10
MOTORS FOR GAS EXPLOSION PROTECTION	E 1 - 8
GENERAL EXPLOSION PROTECTED GEAR UNITS	F 1 - 10
HYBRID MIXTURES	G 1 - 2
PAINTINGS AND COOLING SYSTEMS FOR GEAR UNITS	H 1 - 4
DECENTRALISED INVERTERS AND STARTERS	I 1 - 4
DOCUMENTATION	J 1 - 10

NORD DRIVESYSTEMS Group

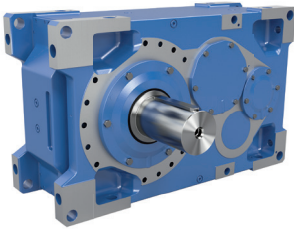

Industrial gear units

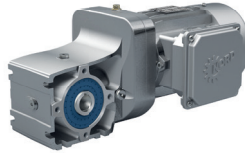

Geared motors



Frequency inverters and motor starters



- ▶ Headquarters and technology centre in Bargteheide near Hamburg.
- ▶ Innovative drive solutions for more than 100 branches of industry.
- ▶ 7 production locations with cutting edge technology produce gear units, motors and drive electronics for complete drive systems from a single source.
- ▶ NORD has 48 subsidiaries in 36 countries and further sales partners in more than 50 countries, providing local stocks, assembly centres, technical support and customer service.
- ▶ More than 4.800 employees throughout the world create customised solutions.



Headquarters in Bargteheide



Gear unit production

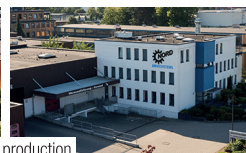

Inverter production



Motor production



Production and assembly



Motor mounting

For many decades, NORD DRIVESYSTEMS has supplied drive units for use in potentially explosive environments. Since 2003 this range has also included specially designed gear units which comply with EU Ex directives (ATEX).

Over the past years a great deal of work has been invested in order to comply with other international regulations such as IEC Ex, EAC Ex, CCC Ex, UKEX as well as the specifications for the North American market.

With a new generation of motors NORD is responding to the stricter efficiency requirements in Europe and China. These motors for dust explosion protection fulfil the ecodesign requirements for electric motors according to EU 2019/1781. NORD frequency inverters are marked with IE2 efficiency.

This catalogue contains information about gear units, motors and inverters for use in gas or dust explosion protection.

The catalogue has a modular structure and if necessary can be compiled separately for gas or dust areas.

In addition, this catalog provides a large amount of additional technical information and supplements catalogues

- ▶ catalogues G1000 (Geared Motors) and M7000 (Motors)
- ▶ the operating instructions B2000 for gear units and B1091 or B1091-1 for motors.

This catalogue provides assistance for use of software tools such as myNORD and NORDcad. The myNORD tool enables quick and simple verification of whether a particular drive is Ex compliant.

Certificates and declarations of conformity can be found on our homepage www.NORD.com
- see ⇒ chapter Documentation  Page J 6-7

Up-to-date and thorough

This catalogue has been compiled with the utmost care on the basis of the current legal situation. We cannot accept any liability for technical changes.

Please note that standards and directives are subject to constant change. Even though we attach great importance to correctness and accuracy, we cannot replace a study of the relevant directives or import regulations with this document.

The nameplates shown in this catalog are examples only.

NORD Drivesystems assumes no responsibility for the up-to-dateness of the data shown on the nameplates.



European Union „ATEX“

For many decades, the EU has been using the ATEX technical standards to ensure the safe operation of machinery and equipment.

With its Ex specifications for mechanical devices regarding the former Directive 94/9/EG the EU acted as a pioneer at that time.

Scope of Application Basis

EU member states + others such as Norway and Switzerland

Technical standards based on IEC standards (IEC - International Electrotechnical Commission)

Based on ...

Directive 2014/34/EU relates to mechanical and electrical devices for use in explosion hazard areas. (In addition to this directive, which directly relates to explosion protection, the Ecodesign, EMC and RoHS directives must also be complied with).

Ex standards

- for motors

- ▶ DIN EN 60079-0, DIN EN 60079-7, DIN EN 60079-31
- ▶ EN 60079-0:2018, EN 60079-31:2014, EN 61800-9-1:2017, EN 61800-5-1:2007+A1:2017, EN 61800-3:2018, EN 61800-9-2:2017, EN 60529:1991+A1:2000+A2:2013+AC:2016, EN 63000:2018

- for inverters

- for gear units

- ▶ DIN EN ISO 80079-36:2016, DIN EN ISO 80079-37:2016

Documents

The suitability of the device for explosion protection is documented by:

- ▶ Type Test Certificate and Declaration of Conformity for Category 2 motors
- ▶ Declaration of Conformity for Category 3 motors
- ▶ Declaration of Conformity for gear units
- ▶ Official bodies involved:
 - Physikalisch-Technische Bundesanstalt PTB
 - DEKRA Testing and Certification GmbH

Audits: The production and quality control of NORD DRIVESYSTEMS is audited at regular intervals by a Notified Body according to the regulations of EU 2014/34.

Energy efficient motors

Energy efficiency requirements for motors:

The regulation (EU) 2019/1781 stipulates minimum efficiencies including explosion-proof motors.

Min. Efficiency acc. to EU 2019/1781			
07/2023 2,4,6 and 8-pole	IE2 Ex db Ex ec Ex tb Ex tc	IE3 Ex db Ex ec Ex tb Ex tc	IE2 Ex eb
07/2021 2,4,6 and 8-pole			
Power [kW]	0,12 ... < 0,75	0,75...1000	0,12...1000



IEC Ex

IEC Ex approval can be helpful for the approval of explosion protected electrical equipment according to national standards.

Australia and New Zealand

Technical standards based on IEC standards
(International Electrotechnical Commission)

IEC Ex 01 IEC Scheme for the Certification to Standards for Electrical Equipment for „Explosive Atmospheres (IEC Ex Scheme) - Basic Rules“ und

IEC Ex 02 IEC Scheme for the Certification to Standards for Electrical Equipment for „Explosive Atmospheres (IEC Ex Scheme) - Rules of Procedure“

- ▶ IEC 60079-0 Explosive atmospheres
- Part 0: Equipment - General requirements

- ▶ IEC 60079-31 Explosive atmospheres
- Part 31: Equipment dust ignition protection by enclosure "t"

- ▶ ISO 80079-36 Non-electrical equipment for Explosive
- Part 36: atmospheres - Basic method and requirements

- ▶ ISO 80079-37 Non-electrical equipment for Explosive
- Part 37: atmospheres - Non electrical type of protection
 constructional safety "c", control of ignition
 source "b", liquid immersion "k"

- ▶ Official bodies involved:
- DEKRA Testing and Certification GmbH and PTB

Audits: IEC Ex audits by Ex- testing laboratories and (Ex-certification bodies) are mandatory. Performed by the PTB as the notified body.

Energy efficiency requirements for motors:

From the point of view of the IEC Ex there are neither requirements nor restrictions with regard to energy efficiency classes. But Australia and New Zealand where IEC Ex is used are requesting IE3. Because of this and because of standardization reasons NORD supplies motors for dust explosion protection in IE3 efficiency.

Currently, NORD does not offer Ex gear units according to IEC Ex.

A drive unit, consisting of a gearbox designed for ATEX explosion protection and a motor with IEC Ex approval is not allowed to be operated within the EU or the European Economic Area. (Special documentation 09/21), see ⇒  page 4.

Scope of Application

Basic

Based on ...

Ex standards
- for motors

- for gear units

Documents

Energy efficient
motors

Attention



Specific national regulations



EAC Ex

EAC (abbreviation for EurAsian Conformity) is a label which states that a product complies with the specifications of the Eurasian Economic Union regarding technical specification, labelling and documentation.

EAC Ex indicated conformity with the standard TR CU 012/2011 1) „On safety of equipment intended for use in Explosive atmospheres“. This contains technical specifications which are largely based on the IEC Ex as well as standards which are used in the EU.

Due to expiring certificates, the delivery of EAC Ex-compliant products from NORD will end on June 30, 2023.

Certified NORD-Products

Scope of Application **Russia, Belarus, Armenia, Kazakhstan and Kyrgyzstan**

Basic

TR CU 012/2011 „On safety of equipment intended for use in Explosive atmospheres“. Technical standards based on IEC (International Electrotechnical Commission) standards. In particular IEC 60079 and IEC 80079.

Standards for Ex motors

Applied standards for Ex motors

ГОСТ Standard	IEC Standards
ГОСТ 31610.0-2014	IEC 60079-0:2011
ГОСТ Р МЭК 60079-31-2013	IEC 60079-31:2013
ГОСТ Р МЭК 60079-7-2012	IEC 60079-7:2006
ГОСТ 31610.15-2014	IEC 60079-15:2010

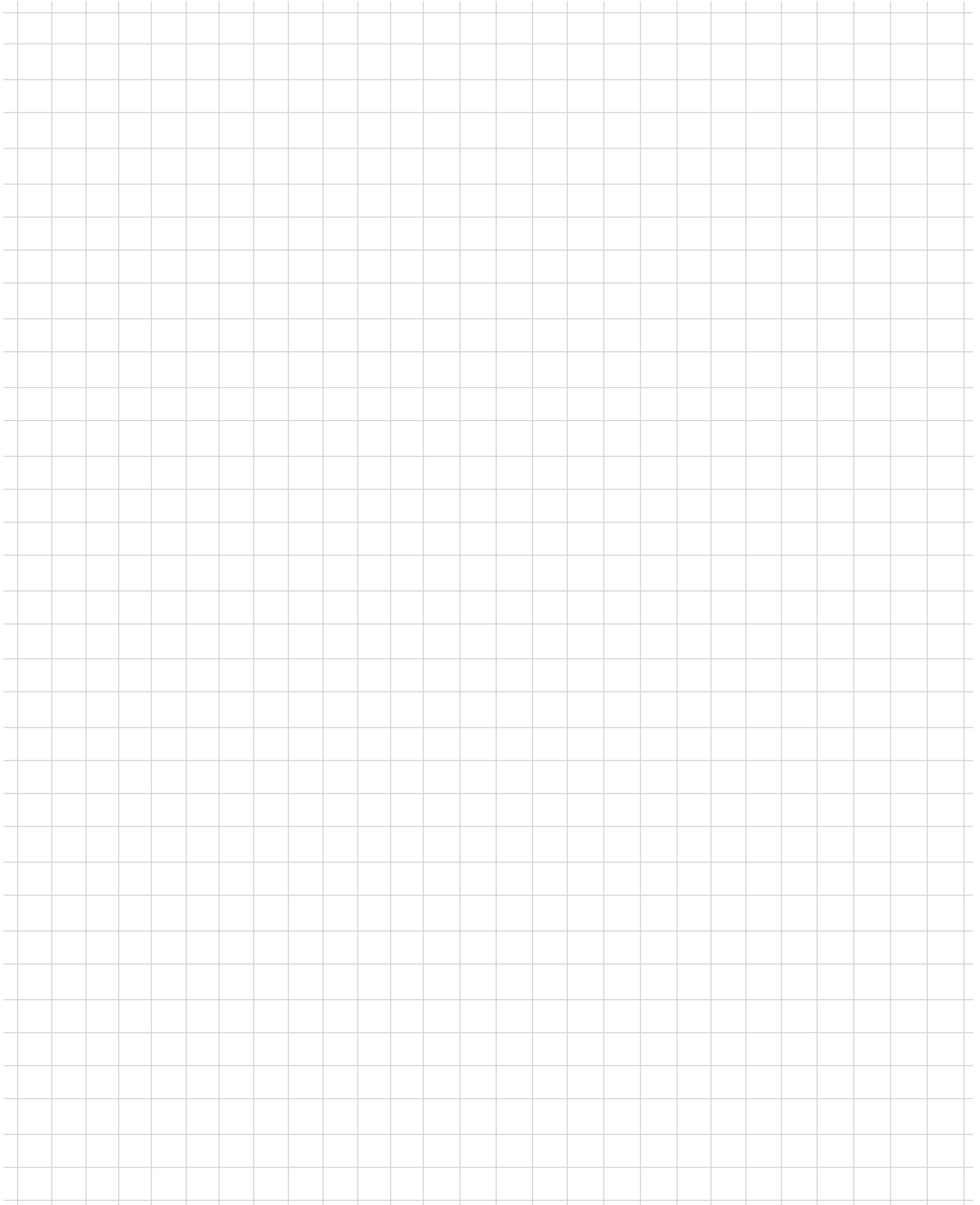



Canada CEC

- ▶ With the 2015 version of the Canadian Electrical Code (CEC) the IEC concept based on Zones was adopted: ⇒
 - 📖 A5, IEC Ex
 - Repairs and extensions of existing systems may continue to be carried out in accordance with the requirements of the division system. ⇒ 📖 A8, HazLoc
 - ▶ Article 18-000, Annex J (see also NEC 500)

CEC
Canadian Electrical Code

CEC in Canada – with CEC 2015 several articles have been completely revised or deleted entirely!

Article	Contents
18-000	Description of scope of application
18-002	Definition of hazard areas
18-004	Classification of gases and dusts
18-006	Classification of gases – Zone 0, 1 and 2
18-008	Classification of dusts – Zone 20, 21 and 22
18 -AnnEx J	Classification according to the division system for Existing plants

The Zone system according to IEC Ex protection is mandatory for all new installations as of 2015!



HazLoc - Explosion protection in North America

Unlike in many other parts of the world, the explosion protection in the US is not based on IEC specifications.

With a similarly high safety level, this results in specific technical solutions as well as a separate categorisation of technical devices with regard to the corresponding explosive environment and the explosive mixture.

The specifications for electrical equipment originate from the NEC The National Electrical Code (NEC) is a safety standard of the United States of America.

This formulates the specifications for the design of electrical installations.

Unlike e.g. in Europe, devices are not categorised according to their use, but rather into „Classes“ and „Divisions“. In the USA the term „HazLoc“ is used in a similar manner to „ATEX“ in Europe.

USA (and Canada for existing plants)

USA: NEC National Electrical Code
(Canada: CEC Canadian Electrical Code)

In 1996, the IEC classification system (categorisation according to Zones) was also introduced for Class I. This change was made by Article 505 of the NEC, which gives the user the opportunity to choose the system that is technically and economically optimal for their purposes.

In 2005 Zones 20, 21 and 22 for areas with flammable dust (Article 506) were introduced.

NEC in the USA

Article	Contents
500	General requirements for Class I, II and III Divisions
501	Requirements for Class I Divisions
502	Requirements for Class II Divisions
503	Requirements for Class III Divisions
504	Requirements for Class I, II and III Divisions with regard to intrinsic safety (IS)
505	General and specific requirements for Zone 0, 1 and 2
506	General and specific requirements for Zone 20, 21 and 22

Safety standard
NEC

HazLoc

Scope of Application
Basic

NEC
National Electrical Code



Class I

Class I - Gas groups A, B, C and D

- ▶ Gases, vapours or aerosols
- ▶ NEC 500 / (CEC 18-000J for Canada up to 2015)
- ▶ Division 1
Areas in which hazardous concentrations of flammable gases or vapours
 - Can be present under normal operating conditions,
 - Can frequently occur during repair and maintenance work,
 - Can occur throughout malfunctions concerning operation. During which, errors occurring in electrical equipment may result in a source of ignition.
- ▶ Division 2
 - Areas in which hazardous concentration of flammable gases or vapours are kept in closed containers or systems and can only be released under fault conditions.

Class II

Class II - Dust groups E, F and G

- ▶ Dusts
- ▶ NEC 500 / (CEC 18-000J for Canada up to 2015)
- ▶ Division 1
Areas in which hazardous concentration of explosive dust atmospheres
 - Can be present under normal operating conditions,
 - Can occur throughout malfunctions concerning operation. During which, errors occurring in electrical equipment may result in a source of ignition.
 - Areas with hazardous quantities of conductive dust (Group E).
- ▶ Division 2
 - Areas in which hazardous concentrations of explosive dust atmospheres can only be released under fault conditions.

Class III

Class III

- ▶ Ignitable fibers and flyings
- ▶ NEC 500 / (CEC 18-000J for Canada up to 2015)
- ▶ Division 1
 - Areas in which flammable fibres and lint occur or are processed.
- ▶ Division 2
 - Areas in which flammable

Comparison of IEC and US explosion protection

Zone 20	Zone 21	Zone 22
is an area in which hazardous explosive atmospheres in the form of a cloud of flammable dust is present in the air constantly, for long periods or frequently.	is an area where it is likely that an explosive atmosphere in the form of a cloud of flammable dust will occasionally occur during normal operation.	is an area where it is likely that an explosive atmosphere in the form of a cloud of flammable dust only occurs in the air for a short period during normal operation.
Division 1		Division 2
is an area in which hazardous concentrations of explosive dust atmospheres <ul style="list-style-type: none"> - Can be present under normal operating conditions, - Can occur throughout malfunctions concerning operation. During which, errors occurring in electrical equipment may result in a source of ignition. 		is an area in which hazardous concentration of explosive dust atmospheres can only be released under fault conditions.
Zone 0	Zone 1	Zone 2
is an area in which the hazardous explosive atmosphere consisting of a mixture of air and flammable gases, vapours or aerosols is present constantly, over long periods or frequently.	is an area in which during normal operation a hazardous atmosphere consisting of an explosive mixture of air and flammable gases, vapours or aerosols can form occasionally.	is an area in which during normal operation a hazardous atmosphere consisting of a mixture or air, flammable gases, vapours or aerosols cannot normally occur, or only occur for short periods.
Division 1		Division 2
is an area in which ignitable concentrations or combustible gases aerosols or liquids <ul style="list-style-type: none"> - Probably occur during normal operating conditions - Regularly occur as a result of maintenance or repair work or due to frequent faults. 		is an area in which ignitable concentrations of combustible gases, aerosols or liquids <ul style="list-style-type: none"> - Probably do not occur during normal operating conditions - Normally occur in closed containers and which can only be released in case of accidents, faults or abnormal operation.



Note

Despite of the same syntax, the US temperature classes differ from those which are used by IEC:

Gas temperature category		
Max. surface temperature	IEC / NEC 505	NEC 500
450°C	T1	T1
300°C	T2	T2
280°C		T2A
260°C		T2B
230°C		T2C
215°C		T2D
200°C	T3	T3
180°C		T3A
165°C		T3B
160°C		T3C
135°C	T4	T4
120°C		T4A
100°C	T5	T5
85°C	T6	T6

For motors, the following specifications apply with regard to energy efficiency classes:

- ▶ USA Regulation: Epcact 2007 EISA (NEMA MG-1)
- ▶ Canada Regulation: CSA C390 (NEMA MG-1)
- ▶ Official body involved:
 - UL and CSA

[Energy efficient](#)

[Motors](#)

[Documents](#)

Regulation

Certified NORD products

Scope of Application

Basic

Energy efficiency

Availability

Restrictions

CCC Ex

Since 1.10.2020, all motors in China which are suitable for use in potentially explosive applications are subject to CCC Ex certification. This applies to motors that are imported to China as well as to motors that are put into operation in China. The regulation applies to both gas and dust explosion protection and all Zones.

CNCA-C23-01:2019 - Compulsory Certification Rules - explosion protected electrical equipment (also called ,CCC Ex').

NORD CCC Ex motors have been certified for the type of protection Ex tD A21 as well as Ex tD A22 according to GB/T 3836.1-2021 and GB/T 3836.31-2021.

China

Products from NORD DRIVESYSTEMS compliant with CCC Ex are tested and produced in a similar manner to products according to Directive 2014/34/EU ATEX.

The technical data of the motors correspond to that of ATEX motors used in Europe - see ⇒  C1-2.

Since June 2020, three-phase motors of energy efficiency grade 3 (IE3) are required in China in accordance with GB 18613-2020. This applies to 2, 4, 6 and 8 pole motors with power ratings from 0.12 to 1000kW. Further information on the scope of application and exceptions can be found at www.nord.com. The motors for the Chinese market have special nameplates, which differ from the nameplates of motors for the European market.

NORD offers a CCC Ex certificate for the following Ex-motors from our own production:

- ▶ Zone 21, equipment category 2D, Ex tb 125°C
- ▶ Zone 22, equipment category 3D, Ex tc 125°C
- ▶ Integral mounting and IEC interface
- ▶ Efficiency class IE3
- ▶ Size 63-180
- ▶ Frequency 50/60 Hz
- ▶ DOL and inverter duty
- ▶ IP Protection Class IP55 for Zone 22
- ▶ IP Protection Class IP66 for Zone 22 optional
- ▶ IP Protection Class IP66 for Zone 21

Motor type	Explanation	CCC Ex	ATEX	IEC Ex	HazLoc
2D	Europe category 2D	--	O.K.	--	--
3D	Europe category 3D	--	O.K.	--	--
ID2	US / Canada Class I Division 2	--	--	--	O.K.
IID2	US / Canada Class II Division 2	--	--	--	O.K..
C2D	China category 2D	O.K.	O.K.	--	--
C3D	China category 3D	O.K.	O.K.	--	--
IDB	IEC Ex category 2D	--	--	O.K.	--
IDC	IEC Ex category 3D	--	--	O.K.	--

-- : not available

O.K.: always additionally marked when selecting a CCC Ex motor

optional: possible in addition to ATEX or CCC Ex

The motors are equipped with two nameplates and are therefore suitable for operation in Europe (ATEX) and China (CCC Ex). The number of type plates (on the motors) depends on the country of manufacture.

- CCC Ex C2D + ATEX 2D = produced in Europe
- CCC Ex C2D = produced in China
- CCC Ex C3D + ATEX 3D = produced in Europe or China

Examples

Type plate on the Motor

(examples)

(examples)

CCC Ex C2D

防爆电机			08514200
Type SK 90LP/4 C2D TF		2023	
3 ~ Mot. No. 200123456-100		12345678	
Th. Cl. 155 (F)	S1	Tamb -20...+40°C	GYJ20.1216
Ex tD A21 IP66 T125°C		GB12476.1-2013 GB12476.5-2013	
Hz	3	20	50
Nm	5,68	10,20	10,10
r/min	34	514	1370
kW	0,02	0,55	1,45
V	33	172	348
A	2,19	3,12	3,53
r/min	1414		
kW	1,5		
V	230/400 Δ / Y		
Hz	50		
A	5,61/3,24		
cos φ	0,81		
IE 3	85,3 %		
15,4 kg			
由变频器供电 f _{max} 100 Hz f _{min} 4 kHz PWM			
Getriebebau NORD GmbH & Co. KG, 22939 Bargteheide / 德国 www.nord.com			

ATEX 2D

0102 EN 60034 / EN 60079		08513920	
Type SK 90LP/4 2D TF		2023	
3 ~ Mot. No. 200123456-100		12345678	
Th. Cl. 155 (F)	IP 66	S1	Baujahr: 2023 (H)
50 Hz	230/400 V Δ/Y	Hz	V
5,61/3,24 A	0,75 kW	A	kW
cos φ 0,81	1414 r/min	cos φ	r/min
IE3-85,3%		BVS 04 ATEX E037	
Kaltleiter für alleinigen Schutz PTC thermistors as sole protection			
15,4 kg			
Getriebebau NORD GmbH & Co. KG, 22939 Bargteheide / GERMANY www.nord.com			

CCC Ex C3D

防爆电机			08514210
Type SK 90LP/4 C3D TF		2023	
3 ~ Mot. No. 200123456-100		12345678	
Th. Cl. 155 (F)	S1	Tamb -20...+40°C	GYJ20.1216
Ex tD A22 IP55 T125°C		GB12476.1-2013 GB12476.5-2013	
Hz	3	20	50
Nm	5,68	10,20	10,10
r/min	34	514	1370
kW	0,02	0,55	1,45
V	33	172	348
A	2,19	3,12	3,53
r/min	1414		
kW	1,5		
V	230/400 Δ / Y		
Hz	50		
A	5,61/3,24		
cos φ	0,81		
IE 3	85,3 %		
15,4 kg			
由变频器供电 f _{max} 100 Hz f _{min} 4 kHz PWM			
Getriebebau NORD GmbH & Co. KG, 22939 Bargteheide / 德国 www.nord.com			

ATEX 3D

		08513480	
Type SK 90LP/4 3D TF		2023	
3 ~ Mot. No. 200123456-100		12345678	
Th. Cl. 155 (F)	IP 55	S1	EN 60034 (H), (A) / EN 60079
Ex tD A22 IP55 T125°C		Dc	
Hz	3	20	87
Nm	5,68	10,20	10,10
r/min	34	514	2483
kW	0,02	0,55	2,99
V Δ	19	99	346
A	3,79	5,40	6,05
r/min	1414		
kW	1,5		
V	230/400 Δ / Y		
Hz	50		
A	5,61/3,24		
cos φ	0,81		
IE 3	85,3 %		
15,4 kg			
Versorgung durch Umrichter f _{max} 100 Hz f _{min} 4 kHz PWM			
Getriebebau NORD GmbH & Co. KG, 22939 Bargteheide / GERMANY www.nord.com			

Basic information regarding European dust explosion protection

General

Explosive dust atmospheres occur in various areas of industry and crafts.

They are usually caused by mixtures of oxygen in combination with circulating or deposited amounts of ignitable dust. Electrical and mechanical equipment for use in explosion hazard areas is subject to special national and international standards and directives.

Explosion protection specifies rules which have the objective of protecting people and objects from possible explosion hazards.

Integrated explosion protection specifies that the measures for explosion protection must be carried out in a defined sequence:

- ▶ Rules of conduct to prevent the occurrence of explosive atmospheres
- ▶ Avoiding ignition of explosive atmospheres
- ▶ Limiting the effect of an explosion to a harmless level

In the design of mechanical and electrical equipment the objective is to prevent ignition or to restrict its effects. For this, the explosion protection regulations come into effect. The term ATEX, which is often used for explosion protection comes from the initial letters of an older French directive „Atmosphères Explosives“. Current European explosion protection regulations are based on Directive 2014/34/EU as the successor of the previously valid EU Directive 94/9/EC. This Directive serves for the harmonisation of statutory regulations of member states for devices and protective systems for proper use in explosion hazard areas. This Directive is also known as the „Manufacturer Directive“ in order to differentiate it from Directive 1999/92 EC which provides information regarding health and safety requirements for workers as well as details of categorisation according to Zones.

EU Directive

Harmonised standards are used to meet basic safety and health requirements, some of which are exemplified below

Standards for electrical devices:

- ▶ DIN EN 60 079 - 0 General Regulations
- ▶ DIN EN 60 079 - 31 Dust explosion protection with housing „t“

Standards

- for electrical
devices

Standards for mechanical devices:

- ▶ DIN EN ISO 80079-36:2016 Basics and requirements
- ▶ DIN EN ISO 80079-37:2016 Protection by constructional safety

- for mechanical
devices

Device groups

Device groups

Directive 2014/34 EU differentiates between two groups of devices:

- ▶ **Group I devices** - indicate equipment which is particularly suitable for mining with device categories M1 and M2
- ▶ **Group II devices** - are suitable for use in other areas which may be endangered by an explosive atmosphere

For most applications the Ex protection data on the gear unit type plate begins with II, so that the special features of Group I systems are not considered in the following.



„ATEX“ Dust explosion protection



Standards - for motors

While Directive 2014/34 EU differentiates between two Groups of Devices I and II, it is further sorted into Groups I, II and III on the basis of DIN EN 60079-0 and -31 standards applicable to motors.

- ▶ **Group I** - indicates devices for mining
- ▶ **Group II** - indicates devices for gas explosion protection
- ▶ **Group III** - indicates devices for dust explosion protection

Zone

Zone

The categorisation into zones is dependent on specific conditions of the workplace – please refer to the stipulations in Directive 1999/92/EC with regard to the frequency of occurrence of dust.

Zone 21

Zone 21:

The area in which an explosive atmosphere consisting of a mixture of air and combustible dust can occasionally form during normal operation.

Zone 22

Zone 22:

The area in which, during normal operation, an explosive atmosphere in the form of a cloud of combustible dust in the air normally does not occur, and if so, only rarely or for a short time.

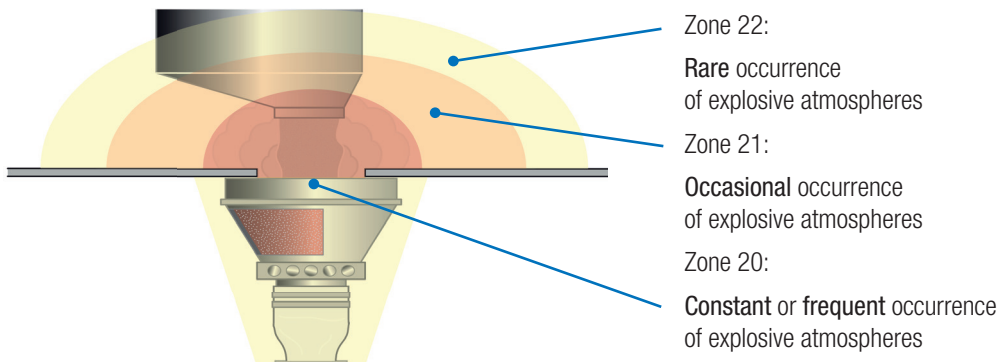

Gear units

A gear unit, as a rule, becomes an explosion-protected system due to a constructionally safe design, use of specific Ex special parts as well as a detailed documentation. For technical requirements of components, please refer to the highly informative DIN EN ISO 80079-37:2016.

Temperature details, e.g.: „125°C“



The Ex protection details on the type plate of Dust Ex drive units provide information about the maximum surface temperature of the device in degrees Celsius.

This is the total of the ambient temperature, the temperature rise as a result of operation as well as safety reserves.

Standard limit value 125°C [140°C]

For most dust-air mixtures in the industry, the temperature rise as a sufficient and practicable. In spite of this, an individual examination must be made for each individual application.

Dust explosion protection Device labeling

Workplace	Presence of an explosive dust atmosphere	occasionally	rarely or for short periods	
	Zone	21	22	
	Dust type	all types	Electrically conducting	Electrically non-conducting
Device labelling	Device Group according to 2014/34/EU	II		
	Group according to DIN EN 60079-0	IIIC	IIIC	IIIB
	Device Category	2D	3D	3D
	Equipment Protection Level EPL according to DIN EN 60079	Db	Dc	Dc
	Protection Class	IP 65	IP65	IP55
	Max. permissible housing temperature 125°C or 140°C			
	Certificate	EC Type Test Certificate, EC Declaration of Conformity on the basis of an EC Type Test Certificate	EC Declaration of Conformity	
	Labelling according to 2014/34 EU	 II 2D	 II 3D	 II 3D
	Labelling according to DIN EN 60079-0 DIN EN 60079-31	e. g.: II 2D Ex tb IIIC T125°C Db	e. g.: II 3D Ex tc IIIC T125°C Dc	e. g.: II 3D Ex tc IIIB T125°C Dc
	Labelling according to DIN EN ISO 80079-36 for gear units	II 2D Ex h IIIC T125°C Db	II 3D Ex h IIIC T125°C Dc	II 3D Ex h IIIB T125°C Dc

Drive dimensioning

The applications of our customers place a wide variety of demands on ATEX compliant operation. We are happy to consider these requirements in the drive design and thus contribute to the safe and reliable operation of systems and machinery. Documentation of special requirements is made on the type plate of the gear unit → Section „Explosion Protected Gear Units in General“ or in the special documentation enclosed with the standard documentation.

ATEX LABELLING DUST FOR MOTORS

II 3D Ex tc IIIB T125°C Dc X

Dust explosion protection

Labelling and categorisation of explosive environment						
Type of material	Frequency of occurrence of flammable material	Categorisation of explosive environment	Labelling of equipment			EPL - Equipment protection level
			Device Group	Device Category		
Dusts	Constantly or frequently present	Zone 20	I			
	Occasionally present	Zone 21	II	1D	2D	Da
	Rarely present (short periods)	Zone 22	II			3D

Type of ignition protection for electrical devices				
Protection principle	Type of ignition protection	Identification	Use in Zone	Standard
Protection with housing	Dust explosion protection	ta tb tc	20 21 22	EN60079-31



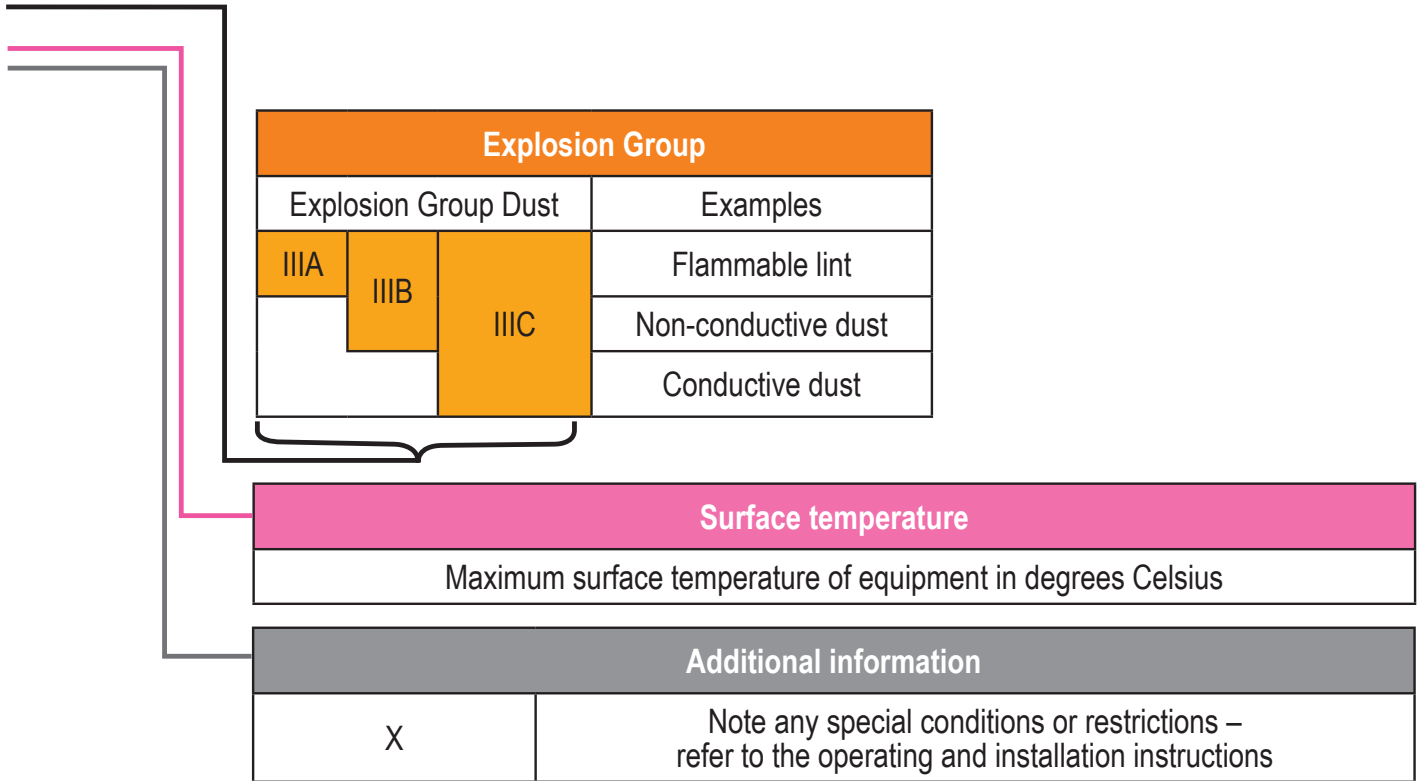

Dust explosion protection

ATEX LABELLING DUST FOR GEAR UNITS

II 3D Ex h IIIC T125°C Dc

Dust explosion protection

Labeling and categorisation of explosive environment						
Type of material	Frequency of occurrence of flammable material	Categorisation of explosive environment	Labelling of equipment			EPL - Equipment Protection Level
			Device Group	Device Category		
Dusts	Constantly or frequently present	Zone 20	I			
	Occasionally present	Zone 21	II	1D		Da
	Rarely present (short periods)	Zone 22	II		2D 3D	Db Dc

Ex h Labelling of mechanical devices according to DIN EN ISO 80079-36

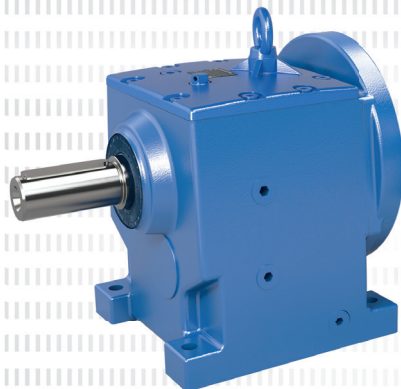

Explosion Group		
Explosion Group Dust		Examples
IIIA	IIIC	suitable for combustible aerosol
IIIB		suitable for combustible aerosol and non-conductive dust
		suitable for combustible aerosol, non-conductive dust and conductive dust
<p style="text-align: center;">Surface temperature</p> <p style="text-align: center;">Maximum surface temperature of equipment in degrees Celsius</p>		

Dust explosion protection



Motors for dust explosion protection according to Directive 2014/34/EU

The motors listed in the following are explosion protected motors from our own production, which can be mounted to NORD gear units either directly or by means of an IEC or NEMA adapter.

Two designs are available, both suitable for mains (DOL) or inverter operation (VFD):

- ▶ Design 2D for Zone 21
- ▶ Design 3D for Zone 22 non-conducting dust

The maximum surface temperature of all these motors is 125°C.

All motors listed in this catalog fulfil the requirements for efficiency according to (EU) 2019/1781. All motors for explosive dust as described below are IE3 efficient motors. This can be also seen in the motor type like 63SP/4. The “P” is the abbreviation for “premium efficiency”.

Mains or inverter operation

ATEX 2D (conducting and non-conducting dust)

1500 r/min	230/400 V & 400/690 V	Ex II 2D IP 66 T 125°C
50 Hz	4-pole	

Type	P_N	n_N	M_N	I_N		cos	η	M_A/M_N	M_K/M_N	I_A/I_N	J	kg
	[kW]	[r/min]	[Nm]	230/400 V [A]	400/690 V [A]	φ	4/4xP _N [%]				[kgm ²]	[kg]
63 SP/4	0,12	1342	0,85	0,71/0,41		0,70	64,8	2,7	2,5	3,5	0,00024	3,8
63 LP/4	0,18	1373	1,25	1,00/0,58		0,66	69,9	3,2	3,1	4,0	0,00033	4,7
71 SP/4	0,25	1408	1,70	1,21/0,70		0,73	73,5	3,2	3,2	5,5	0,00086	6,1
71 LP/4	0,37	1397	2,53	1,61/0,93		0,78	77,3	2,8	2,8	5,3	0,00110	7,2
80 SP/4	0,55	1402	3,75	2,46/1,42		0,75	81,4	2,6	2,8	4,9	0,00145	9,7
80 LP/4	0,75	1414	5,06	3,08/1,78		0,75	83,7	3,0	3,1	5,8	0,0019	10,2
90 SP/4	1,10	1429	7,35	4,24/2,45		0,79	85,0	3,6	4,0	7,2	0,0034	15,1
90 LP/4	1,50	1414	10,1	5,61/3,24		0,81	85,3	3,3	3,5	6,8	0,0039	15,4
100 LP/4	2,20	1460	14,4	7,79/4,50		0,81	88,1	2,6	3,9	8,1	0,0081	24,5
100 AP/4	3,00	1454	19,7	10,8/6,25	6,23/3,60	0,81	88,1	2,4	3,6	7,7	0,0081	27,4
112 MP/4	4,00	1440	26,5	13,7/7,94	7,91/4,57	0,84	88,6	3,3	3,5	8,3	0,014	35,5
132 SP/4	5,50	1465	35,8	19,5/11,2	11,2/6,46	0,79	90,9	3,8	4,1	9,7	0,032	55
132 MP/4	7,50	1458	49,1	26,8/15,5	15,4/8,91	0,79	90,4	3,8	4,2	8,8	0,035	62
160 SP/4	9,20	1474	59,6	29,4/17,0	16,9/9,76	0,86	91,0	2,9	3,3	9,5	0,067	93
160 MP/4	11,0	1467	71,6	35,3/20,4	20,3/11,7	0,85	91,4	2,9	3,4	9,4	0,067	93
160 LP/4	15,0	1467	97,6	47,6/27,5	27,3/15,8	0,87	92,3	3,8	4,3	9,9	0,092	122
180 MP/4	18,5	1480	119	60,3/34,8	34,6/20,0	0,83	93,1	3,4	3,8	10,0	0,16	155
180 LP/4	22,0	1475	142	70,7/40,8	40,6/23,4	0,85	93,1	2,8	3,2	8,1	0,16	155

* Version B5, without options

400/690V not available for inverter duty

ATEX 2D DOL

ATEX 2D VFD

Name plates (examples)

Type SK 90LP/4 2D TF 2023
 3 ~ Mot. No. 200123456-100 12345678
 Th. Cl. I155 (F) IP 66 S1 Baujahr: 2023 (H)
 50 Hz 230/400 V Δ/Y Hz V
 5,61/3,24 A 0,75 kW A kW
 cos φ 0,81 1414 r/min cos φ r/min
 IE3-85,3%
 Ex II 2D Ex tb IIIC T125°C Db BVS 04 ATEX E037
 Kaltleiter für alleinigen Schutz
 PTC thermistors as sole protection
 15,4 kg

Type SK 90LP/4 2D TF 2023
 3 ~ Mot. No. 200123456-100 12345678
 Th. Cl. 155 (F) IP 66 S1 EN 60034 (H), (A) / EN 60079
 Ex II 2D Ex tb IIIC T125°C Db BVS 04 ATEX E 037

Hz	3	20	50	70	r/min	1414
Nm	5,68	10,20	10,10	8,19	kW	1,5
r/min	34	514	1370	1861	V	230/400Δ / Y
kW	0,02	0,55	1,45	1,60	Hz	50
V	33	172	348	351	A	5,61/3,24
A	2,19	3,12	3,53	4,01	cos φ	0,81
					IE 3	85,3 %

 15,4 kg
 Versorgung durch Umrichter f_{max} 100 Hz f_{min} 4 kHz PWM



Dust Explosion protection „ATEX“



Motor energy efficiency: Premium IE3

ATEX 3D (non-conducting dust)

Dust explosion protection

1500 r/min 50 Hz		230/400 V & 400/690 V 4-pole					Ex II 3D Ex tc IIIB T 125°C Dc							
Type	P _N	n _N	M _N	I _N		cos	η			M _A /M _N	M _K /M _N	I _A /I _N	J	kg
	[kW]	[r/min]	[Nm]	230/400 V	400/690 V	φ	1/2xP _N	3/4xP _N	4/4xP _N				[kgm ²]	[kg]
				[A]	[A]		[%]	[%]	[%]					*
63 SP/4	0,12	1342	0,85	0,71/0,41		0,70	58,3	64,7	66,4	2,7	2,5	3,5	0,00024	3,8
63 LP/4	0,18	1373	1,25	1,00/0,58		0,66	62,2	65,6	69,9	3,2	3,1	4,0	0,00033	4,7
71 SP/4	0,25	1408	1,70	1,21/0,70		0,73	68,2	73,0	73,5	3,2	3,2	5,5	0,00086	6,1
71 LP/4	0,37	1397	2,53	1,61/0,93		0,78	72,8	76,7	77,3	2,8	2,8	5,3	0,00110	7,2
80 SP/4	0,55	1402	3,75	2,46/1,42		0,75	79,5	81,8	81,4	2,6	2,8	4,9	0,00145	9,7
80 LP/4	0,75	1414	5,06	3,08/1,78		0,75	83,7	84,7	83,7	3,0	3,1	5,8	0,0019	10,2
90 SP/4	1,10	1429	7,35	4,24/2,45		0,79	79,4	83,6	85,0	3,6	4,0	7,2	0,0034	15,1
90 LP/4	1,50	1414	10,1	5,61/3,24		0,81	86,6	86,3	85,3	3,3	3,5	6,8	0,0039	15,4
100 LP/4	2,20	1460	14,4	7,79/4,50		0,81	88,7	89,6	88,1	2,6	3,9	8,1	0,0081	24,5
100 AP/4	3,00	1454	19,7	10,8/6,25	6,23/3,60	0,81	88,4	88,8	88,1	2,4	3,6	7,7	0,0081	27,4
112 MP/4	4,00	1440	26,5	13,7/7,94	7,91/4,57	0,84	88,9	89,2	88,6	3,3	3,5	8,3	0,014	35,5
132 SP/4	5,50	1465	35,8	19,5/11,2	11,2/6,46	0,79	90,6	91,5	90,9	3,8	4,1	9,7	0,032	55
132 MP/4	7,50	1458	49,1	26,8/15,4	15,4/8,91	0,79	90,2	90,5	90,4	3,8	4,2	8,8	0,035	62
160 SP/4	9,20	1474	59,6	29,4/17,0	16,9/9,76	0,86			91,0	2,9	3,3	9,5	0,067	93
160 MP/4	11,0	1467	71,6	35,3/20,4	20,3/11,7	0,85	91,6	92,0	91,4	2,9	3,4	9,4	0,067	93
160 LP/4	15,0	1467	97,6	47,6/27,5	27,3/15,8	0,87	92,3	92,8	92,3	3,8	4,3	9,9	0,092	122
180 MP/4	18,5	1480	119	60,3/34,8	34,6/20,0	0,83	92,4	93,1	93,1	3,4	3,8	10,0	0,16	155
180 LP/4	22,0	1475	142	70,7/40,8	40,6/23,4	0,85	93,2	93,5	93,1	2,8	3,2	8,1	0,16	155
225 RP/4	30,0	1485	193	96,0/55,4	55,4/32,0	0,84	93,6	94,3	94,1	3,0	3,4	8,58	0,49	315
225 SP/4	37,0	1485	238	119,3/68,9	68,9/39,8	0,83	93,6	94,4	94,1	2,9	3,2	8,4	0,54	330
225 MP/4	45,0	1485	289	142,4/82,2	82,2/47,4	0,84	94,6	94,9	94,6	3,0	3,4	8,8	0,67	365
250 WP/4 ¹⁾	55,0	1480	355		96,8/55,9	0,88	95,2	95,0	94,6	2,6	2,8	7,7	0,82	400

* Version B5, without options

¹⁾ Direct mount, no IEC B5 mount possible

400/690V not available for inverter duty

Type plates
(examples)

ATEX 3D DOL

		EN 60034 / EN 60079		06813350	
Type SK 90LP/4 3D TF					
3 ~ Mot. No. 200123456-100		12345678			
Th. Cl.155 (F) IP 55		S1		Baujahr: 2022 (H)	
50 Hz	230/400	V Δ/Y	Hz	V	
⊕	5,61/3,24	A	1,5	kW	A
⊖	cos φ 0,81	1414	r/min	cos φ	r/min
IE3-85,3%					
⊕ II 3D Ex tc IIIB T125°C Dc					
Kaltleiter für alleinigen Schutz					
PTC thermistors as sole protection					
Getriebebau NORD GmbH & Co. KG, 22939 Bargteheide / GERMANY www.nord.com					

ATEX 3D VFD

		EN 60034 (H), (A) / EN 60079		06813400	
Type SK 90LP/4 3D TF					
3 ~ Mot. No. 200123456-100		12345678			
Th. Cl. 155 (F) IP 55		S1		EN 60034 (H), (A) / EN 60079	
⊕ II 3D Ex tc IIIB T125°C Dc					
Hz	3	20	50	70	r/min 1414
Nm	5,68	10,20	10,10	8,19	kW 1,5
r/min	34	514	1370	1861	V 230/400 Δ / Y
kW	0,02	0,55	1,45	1,60	Hz 50
V	33	172	348	351	A 5,61/3,24
A	2,19	3,12	3,53	4,01	cos φ 0,81
IE 3 85,3 %					
15,4 kg					
Versorgung durch Umrichter f _{max} 100 Hz f _{min} 4 kHz PWM					
Getriebebau NORD GmbH & Co. KG, 22939 Bargteheide / GERMANY www.nord.com					



2D according to Directive 2014/34 EU		3D according to Directive 2014/34 EU	
▶ TF	Temperature sensor (Standard)	▶ TF	Temperature sensor (Standard)
▶ RD*	Protection Canopy	▶ RD*	Protection Canopy
▶ WE	2nd shaft end	▶ WE	2nd shaft end
▶ KB	Condensation drain hole	▶ KB	Condensation drain hole
▶ B3	Foot-mounted version	▶ B3	Foot-mounted version
		▶ RLS	Backstop for sizes 80 to 132
		▶ BRE	Brake
		▶ HL	Manual brake release
		▶ FHL	Lockable hand release for brake
		▶ F	External fan for sizes 63 to 180
		▶ IG + F**	Incremental encoder plus external fan

Motor options

* If the fan cowl is inclined at an angle of 20° to 90° to the vertical, e.g. IM V1, IM V5 models, the motors are generally designed with a protective cover RD on the fan cowl. This rule applies to all Ex motors from NORD.

** Motors including the IG option are marked with a surface temperature of 140°C.

2D and 3D motors intended to be used on inverter are 230/400V only.



Attention

Extreme ambient temperatures for 2D and 3D motors

Operation is possible in ambient temperature range from -20°C to +40°C.
For other temperatures please contact NORD.

Dust Explosion protection „IEC Ex“



Motors for dust explosion protection according to IEC Ex

The motors listed in the following are explosion protected motors from our own production, which can be fitted to NORD gear units either directly or by means of an IEC cylinder.

The motors have two versions which are exclusively available as follows:

- ▶ Version IDB IP **66** for Zone 21 + 22
- ▶ Version IDC IP **55** for Zone 22

The maximum surface temperature is normally 125°C, but this may be 140°C in specially labelled exceptional cases.

Technically, these motors are similar to NORD Ex motors for dust application such as those on ⇒ Page C1 with acceptance according to Directive 2014/34 EU. However, they have a smaller number of options.

Motor energy efficiency IE3:

IEC Ex IDB conductive and non-conductive dust

Dust explosion protection

1500 r/min	230/400 V & 400/690 V	Ex tb IIIC T125° C Db
50 Hz	4-pole	

S1												
Type	P _N	n _N	M _N	I _N		cos φ	η**	M _A /M _N	M _K /M _N	I _A /I _N	J	
				230/400 V	400/690 V							
				[A]	[A]							
[kW]	[r/min]	[Nm]	[A]	[A]	φ	[%]				[kgm ²]	[kg]	
63 SP/4	0,12	1342	0,85	0,71/0,41		0,70	64,8	2,7	2,5	3,5	0,00024	3,8
63 LP/4	0,18	1373	1,25	1,00/0,58		0,66	69,9	3,2	3,1	4,0	0,00033	4,7
71 SP/4	0,25	1408	1,70	1,21/0,70		0,73	73,5	3,2	3,2	5,5	0,00086	6,1
71 LP/4	0,37	1397	2,53	1,61/0,93		0,78	77,3	2,8	2,8	5,3	0,00110	7,2
80 SP/4	0,55	1402	3,75	2,46/1,42		0,75	81,4	2,6	2,8	4,9	0,00145	9,7
80 LP/4	0,75	1414	5,06	3,08/1,78		0,75	83,7	3,0	3,1	5,8	0,0019	10,2
90 SP/4	1,10	1429	7,35	4,24/2,45		0,79	85,0	3,6	4,0	7,2	0,0034	15,1
90 LP/4	1,50	1414	10,1	5,61/3,24		0,81	85,3	3,3	3,5	6,8	0,0039	15,4
100 LP/4	2,20	1460	14,4	7,79/4,50		0,81	88,1	2,6	3,9	8,1	0,0081	24,5
100 AP/4	3,00	1454	19,7	10,8/6,25	6,23/3,60	0,81	88,1	2,4	3,6	7,7	0,0081	27,4
112 MP/4	4,00	1440	26,5	13,7/7,94	7,91/4,57	0,84	88,6	3,3	3,5	8,3	0,014	35,5
132 SP/4	5,50	1465	35,8	19,5/11,2	11,2/6,46	0,79	90,9	3,8	4,1	9,7	0,032	55
132 MP/4	7,50	1458	49,1	26,8/15,5	15,4/8,91	0,79	90,4	3,8	4,2	8,8	0,035	62
160 MP/4	11,0	1467	71,6	35,3/20,4	20,3/11,7	0,85	91,4	2,9	3,4	9,4	0,067	93
160 LP/4	15,0	1467	97,6	47,6/27,5	27,3/15,8	0,87	92,3	3,8	4,3	9,9	0,092	122
180 MP/4	18,5	1480	119	60,3/34,8	34,6/20,0	0,83	93,1	3,4	3,8	10,0	0,16	155
180 LP/4	22,0	1475	142	70,7/40,8	40,6/23,4	0,85	93,1	2,8	3,2	8,1	0,16	155

* Version B5, without options Suitable for inverter operation. See data for the EX motors intended for the European market

** Measured values (The value on the rating plate may differ, as the rating plate reflects the minimum values for efficiency according to the standard).

Type plates (examples)

IDB 50 Hz Mains operation DOL

IDB 50 Hz Inverter operation VFD

IEC / EN 60034 / EN 60079

Type SK 90LP/4 IDB TF

3 ~ Mot. No. 123456789-100

Th. Cl. 155 (F) IP 66 S1 Baujahr: 2021 (H)

50 Hz 230/400 V Hz V

5,61/3,24	A	1,5	kW	A	kW
cos φ 0,81	1414	r/min	cos φ	r/min	r/min

IE3-85,3%

Ex tb IIIC T125°C Db | IECEx BVS 14.0022

Kaltleiter für alleinigen Schutz
PTC thermistors as sole protection

15,4 kg

Getriebebau NORD GmbH & Co. KG, 22939 Bargteheide / GERMANY www.nord.com

IEC EN 60034 (H), (A) IEC 60079

Type SK 90LP/4 IDB TF 2021

3 ~ Mot. No. 200123456-100 12345678

Th. Cl. 155 (F) IP 66 S1 IEC EN 60034 (H), (A) IEC 60079

Ex tb IIIC T125°C Db IECEx BVS 14.0022

Hz	3	20	50	70	r/min	1414
Nm	5,68	10,20	10,10	8,19	kW	1,5
r/min	34	514	1370	1861	V	230/400 Δ / Y
kW	0,02	0,55	1,45	1,60	A	5,61/3,24
V	33	172	348	351	cos φ	0,81
A	2,19	3,12	3,53	4,01	IE 3	85,3 %

15,4 kg

Versorgung durch Umrichter f_{max} 100 Hz f_{min} 4 kHz PWM

Getriebebau NORD GmbH & Co. KG, 22939 Bargteheide / GERMANY www.nord.com



Motor energy efficiency IE3

IEC Ex IDC non-conductive dust

1500 r/min 50 Hz		230/400 V & 400/690 V 4-pole								Ex tc IIIB T125°C Dc				
Type	P _N [kW]	η _N [r/min]	M _N [Nm]	I _N		cos φ	η**			M _A /M _N	M _K /M _N	I _A /I _N	J [kgm ²]	kg
				230/400 V [A]	400/690 V [A]		1/2xP _N [%]	3/4xP _N [%]	4/4xP _N [%]					*
63 SP/4	0,12	1342	0,85	0,71/0,41		0,70	58,3	64,7	66,4	2,7	2,5	3,5	0,00024	3,8
63 LP/4	0,18	1373	1,25	1,00/0,58		0,66	62,2	65,6	69,9	3,2	3,1	4,0	0,00033	4,7
71 SP/4	0,25	1408	1,70	1,21/0,70		0,73	68,2	73,0	73,5	3,2	3,2	5,5	0,00086	6,1
71 LP/4	0,37	1397	2,53	1,61/0,93		0,78	72,8	76,7	77,3	2,8	2,8	5,3	0,00110	7,2
80 SP/4	0,55	1402	3,75	2,46/1,42		0,75	79,5	81,8	81,4	2,6	2,8	4,9	0,00145	9,7
80 LP/4	0,75	1414	5,06	3,08/1,78		0,75	83,7	84,7	83,7	3,0	3,1	5,8	0,0019	10,2
90 SP/4	1,10	1429	7,35	4,24/2,45		0,79	79,4	83,6	85,0	3,6	4,0	7,2	0,0034	15,1
90 LP/4	1,50	1414	10,1	5,61/3,24		0,81	86,6	86,3	85,3	3,3	3,5	6,8	0,0039	15,4
100 LP/4	2,20	1460	14,4	7,79/4,50		0,81	88,7	89,6	88,1	2,6	3,9	8,1	0,0081	24,5
100 AP/4	3,00	1454	19,7	10,8/6,25	6,23/3,60	0,81	88,4	88,8	88,1	2,4	3,6	7,7	0,0081	27,4
112 MP/4	4,00	1440	26,5	13,77/7,94	7,91/4,57	0,84	88,9	89,2	88,6	3,3	3,5	8,3	0,014	35,5
132 SP/4	5,50	1465	35,8	19,5/11,2	11,2/6,46	0,79	90,6	91,5	90,9	3,8	4,1	9,7	0,032	55
132 MP/4	7,50	1458	49,1	26,8/15,4	15,4/8,91	0,79	90,2	90,5	90,4	3,8	4,2	8,8	0,035	62
160 MP/4	11,0	1467	71,6	35,3/20,4	20,3/11,7	0,85	91,6	92,0	91,4	2,9	3,4	9,4	0,067	93
160 LP/4	15,0	1467	97,6	47,6/27,5	27,3/15,8	0,87	92,3	92,8	92,3	3,8	4,3	9,9	0,092	122
180 MP/4	18,5	1480	119	60,3/34,8	34,6/20,0	0,83	92,4	93,1	93,1	3,4	3,8	10,0	0,16	155

Dust explosion protection

* Version B5, without Option Suitable for inverter operation. See data for the EX motors, intended for the European market

** Measured values (The value on the rating plate may differ, as the rating plate reflects the minimum values for efficiency according to the standard).

IDC 50 Hz Mains operation DOL

IEC / EN 60034 / EN 60079		08513660
Type SK 90LP/4 IDC TF		
3 ~ Mot. No. 200123456-100		12345678
Th. Cl.155 (F) IP 55	S1	Baujahr: 2021 (H)
50 Hz	230/400 V	Hz V
5,61/3,24 A	1,5 kW	A kW
cos φ 0,81	1414 r/min	cos φ r/min
IE3-85,3%		
Ex tc IIIB T125°C Dc IECEx BVS 14.0022		
Kaltleiter für alleinigen Schutz		
PTC thermistors as sole protection		
15,4 kg		
<small>Getriebefabrik NORD GmbH & Co. KG, 22939 Bargteheide / GERMANY www.nord.com</small>		

IDC 50 Hz Inverter operation VFD

IEC / EN 60034 / EN 60079		08514370
Type SK 90LP/4 IDC TF		
3 ~ Mot. No. 200123456-100		2021
Th. Cl. 155 (F) IP 55 S1		12345678
IEC EN 60034 (H),(A) IEC 60079		
Ex tc IIIB T125°C Dc IECEx BVS 14.0022		
Hz	3 20 50 70	r/min 1414
Nm	5,68 10,20 10,10 8,19	kW 1,5
r/min	34 514 1370 1861	V 230/400 Δ / Y
kW	0,02 0,55 1,45 1,60	Hz 50
V	33 172 348 351	A 5,61/3,24
A	2,19 3,12 3,53 4,01	cos φ 0,81
15,4 kg		IE 3 85,3 %
Vorsorgung durch Umrichter f _{max} 100 Hz f _{min} 4 kHz PWM		
<small>Getriebefabrik NORD GmbH & Co. KG, 22939 Bargteheide / GERMANY www.nord.com</small>		

Type plates (examples)

Permissible motor options for motors as per IEC Ex

▶ TF	Temperature sensor (Standard)
▶ RD	Protection Canopy
▶ WE	2nd shaft end
▶ KB	Condensation hole
▶ B3	Foot-mounted version

Motor options



Dust Explosion protection „HazLoc“



Motors for the North American market

Class II, Division 2, Groups F and G temperature code 165°C, operating mode S1, IP 55, IP 66, -20°C to +40°C

These are motors which are used in areas in which flammable mixtures of dust and oxygen do not occur under normal conditions, but in exceptional cases can not be ruled out.

These motors are available in efficiency classes Standard „IE2“ and Premium „IE3“. The motor data is listed for the voltages 230/460 V and 332/575 V which are especially important for the USA and Canada.

All motors are suitable for mains operation. The Premium efficient motors can also be used for inverter duty. See page C8.

Mains operation

US motor data - dust

1800 r/min 60 Hz		332/575 V 4 - pole									
---------------------	--	-----------------------	--	--	--	--	--	--	--	--	--

Typ		P _N [kW]	P _N [hp]	n _N [r/min]	U [V]	f [Hz]	M [Nm]	I [A]	cos φ [°]	I _A /I _N	J [kgm ²]
63	S/4 TF IID2	0,12	0,16	1702	332/575	60	0,67	0,65/0,37	0,58	3,34	0,00021
63	L/4 TF IID2	0,18	0,25	1711	332/575	60	1,00	0,92/0,53	0,55	3,70	0,00028
71	S/4 TF IID2	0,25	0,33	1690	332/575	60	1,41	0,90/0,52	0,73	4,33	0,00072
71	L/4 TF IID2	0,37	0,50	1710	332/575	60	2,07	1,26/0,73	0,71	4,84	0,00086
80	S/4 TF IID2	0,55	0,75	1710	332/575	60	3,07	1,84/1,06	0,71	4,47	0,00109

and Inverter operation

✓	80	LP/4 TF IID2	0,75	1,00	1730	332/575	60	4,14	2,16/1,25	0,70	6,50	0,0019
✓	90	SP/4 TF IID2	1,10	1,50	1740	332/575	60	6,04	2,91/1,68	0,76	8,50	0,0034
✓	90	LP/4 TF IID2	1,50	2,00	1730	332/575	60	8,28	3,88/2,24	0,78	7,70	0,0039
✓	100	LP/4 TF IID2	2,20	3,00	1770	332/575	60	11,87	5,32/3,07	0,79	9,20	0,0081
✓	112	MP/4 TF IID2	3,70	5,00	1755	332/575	60	20,13	9,00/5,20	0,80	9,60	0,014
✓	132	SP/4 TF IID2	5,50	7,50	1770	332/575	60	29,68	13,5/7,81	0,77	10,20	0,032
✓	132	MP/4 TF IID2	7,50	10,0	1765	332/575	60	40,58	18,6/10,7	0,77	9,60	0,035
✓	160	MP/4 TF IID2	11,0	15,0	1770	332/575	60	59,35	24,7/14,2	0,84	8,80	0,067
✓	160	LP/4 TF IID2	15,0	20,0	1775	332/575	60	80,70	33,0/19,0	0,85	10,80	0,092
✓	180	MP/4 TF IID2	18,5	25,0	1780	332/575	60	99,00	24,2/14,0	0,82	10,10	0,160
✓	180	LP/4 TF IID2	22,0	30,0	1780	332/575	60	118,00	27,8/16,0	0,85	8,80	0,160

✓ these motors are also suitable for inverter operation



US-motor data - dust

1800 r/min 60 Hz	230/460 V 4 - pole
-----------------------------------	-------------------------------------

Mains operation

Type	P _N	P _N	n _N	U	f	M	I	cos	I _A /I _N	J
	[kW]	[hp]	[r/min]	[V]	[Hz]	[Nm]	[A]	[°]		[kgm ²]
63 S/4 TF IID2	0,12	0,16	1687	230/460	60	0,68	0,94/0,47	0,54	3,21	0,00021
63 L/4 TF IID2	0,18	0,25	1706	230/460	60	1,01	1,18/0,59	0,57	3,58	0,00028
71 S/4 TF IID2	0,25	0,33	1710	230/460	60	1,40	1,56/0,78	0,64	3,00	0,00072
71 L/4 TF IID2	0,37	0,50	1715	230/460	60	2,06	1,89/0,94	0,69	4,84	0,00086
80 S/4 TF IID2	0,55	0,75	1710	230/460	60	3,07	2,70/1,35	0,71	3,60	0,00109
80 LP/4 TF IID2	0,75	1,00	1730	230/460	60	4,14	3,14/1,57	0,70	6,50	0,0019 ✓
90 SP/4 TF IID2	1,10	1,50	1740	230/460	60	6,04	4,20/2,10	0,76	8,40	0,0034 ✓
90 LP/4 TF IID2	1,50	2,00	1730	230/460	60	8,28	5,60/2,80	0,78	7,60	0,0039 ✓
100 LP/4 TF IID2	2,20	3,00	1770	230/460	60	11,87	7,68/3,07	0,79	9,20	0,0081 ✓
112 MP/4 TF IID2	3,70	5,00	1755	230/460	60	20,13	13,0/6,50	0,80	9,50	0,014 ✓
132 SP/4 TF IID2	5,50	7,50	1770	230/460	60	29,68	19,5/9,75	0,77	10,20	0,032 ✓
132 MP/4 TF IID2	7,50	10,0	1765	230/460	60	40,58	26,7/13,4	0,77	9,60	0,035 ✓
160 MP/4 TF IID2	11,0	15,0	1770	230/460	60	59,35	35,6/17,8	0,84	8,80	0,067 ✓
160 LP/4 TF IID2	15,0	20,0	1775	230/460	60	80,70	47,6/23,8	0,85	10,80	0,092 ✓
180 MP/4 TF IID2	18,5	25,0	1780	230/460	60	99,00	60,6/30,3	0,82	10,10	0,160 ✓
180 LP/4 TF IID2	22,0	30,0	1780	230/460	60	118,00	69,6/34,8	0,85	8,80	0,160 ✓

✓ these motors are also suitable for inverter operation

and operation with inverter

Dust explosion protection

IDC 60 Hz Mains operation DOL

Type SK 90 LP/4 CUS IID2 TF											2024
3 ~ Mot. No. 202592077-100											12345678
INS F	NEMA	IP55	CONT S1	AMB 40 °C		TEFC		DP			
60 Hz	230/460	V YY/Y	EFF _η = IE3	86,5%		CODE K					
	5,60/2,80 A	2,00 hp	1,5 kW/SF	1,15							
	PF 0,78	1730 r/min									
INVERTER DUTY VPWM CT Class II DIV2 Group F&G T3B -165°C											
Hz	r/min	Nm	lb-in	hp	A						
7	110	6,32	55,91	0,10	4,64/2,32						
83	2400	6,32	55,91	2,00	4,64/2,32						
16,7 kg		MB 20 Nm		230 VAC		205 VDC					
Over Temp Prot-2 Class F											
<small>Getriebebau NORD GmbH & Co. KG, 22839 Bargteheide / GERMANY, www.nord.com</small>											

IDC 60 Hz Inverter operation VFD

Type SK 90 LP/4 CUS IID2 BRE20 TF											2024
3 ~ Mot. No. 202592077-100											12345678
INS F	NEMA	IP55	CONT S1	AMB 40 °C		TEFC		DP			
60 Hz	230/460	V YY/Y	EFF _η = IE3	86,5%		CODE K					
	5,60/2,80 A	2,00 hp	1,5 kW/SF	1,15							
	PF 0,78	1730 r/min									
INVERTER DUTY VPWM CT Class II DIV2 Group F&G T3B -165°C											
Hz	r/min	Nm	lb-in	hp	A						
7	110	6,32	55,91	0,10	4,64/2,32						
83	2400	6,32	55,91	2,00	4,64/2,32						
16,7 kg		MB 20 Nm		230 VAC		205 VDC					
Over Temp Prot-2 Class F											
<small>Getriebebau NORD GmbH & Co. KG, 22839 Bargteheide / GERMANY, www.nord.com</small>											

Type plates (examples)

Permissible motor options for motors with special voltages between 200V - 600V

▶ TF	Temperature sensor (Standard)
▶ TW	Temperature sensor (bi-metal)
▶ RD	Protection Canopy
▶ RDD	Double fan cowl
▶ WE	2nd shaft end
▶ BRE	Brake

Motor options



Dust Explosion protection „HazLoc“



Operation with frequency inverters

NORD motors that comply with Class II Div.2 are suitable for operation on a frequency inverter. The variable speed range requires temperature monitoring using temperature sensors. The approved speed ranges can be found in the following table:

Motortype	Typ VR 5:1			Typ VN 10:1			Typ VW 20:1		
	M	nmax	nmin	M	nmax	nmin	M	nmax	nmin
	[Nm]	[r/min]	[r/min]	[Nm]	[r/min]	[r/min]	[Nm]	[r/min]	[r/min]
SK 80 LP/4 IID2	4,32	1680	350	3,16	1800	175	2,98	2400	110
SK 90 SP/4 IID2	6,10	1750	355	3,96	1800	185	4,45	2400	80
SK 90 LP/4 IID2	8,63	1695	360	6,28	1800	115	6,32	2400	110
SK 100 LP/4 IID2	12,50	1700	315	8,19	1800	100	9,25	2400	65
SK 112 MP/4 IID2	20,30	1750	360	11,87	1800	180	14,84	2400	115
SK 132 SP/4 IID2	30,50	1750	350	19,78	1800	185	22,25	2400	120
SK 132 MP/4 IID2	41,00	1745	350	29,67	1800	175	29,67	2400	125
SK 160 MP/4 IID2	60,30	1760	345	39,56	1800	175	44,51	2400	120
SK 160 LP/4 IID2	80,70	1760	350	59,34	1800	180	59,34	2400	115
SK 180 MP/4 IID2	100,60	1760	355	79,12	1800	180	74,18	2400	125
SK 180 LP/4 IID2	121,00	1765	350	98,90	1800	175	89,01	2400	120

Dust explosion protection



Dust Explosion protection „CCC Ex“



Motors for dust explosion protection according to CCC Ex mains operation only

The motors listed in the following are explosion protected motors from our own production, which can be fitted to NORD gear units either directly or by means of an IEC cylinder.

Mains operation

The motors have two versions which are exclusively available as follows:

- ▶ Version C2D IP66 for conductive and non-conductive dust
- ▶ Version C3D IP55 or IP56 for non-conducting dust

The maximum surface temperature is 125°C. Ambient temperature range -20°C to +40°C. The motors can be used at main operation or for inverter duty in two different versions for 50 or 87Hz characteristic. Technically, these motors are similar to NORD Ex motors for dust application such as those on ⇒ Page C1 and C2. For further information see ⇒ pages A12 and A13.

All motors listed in this catalog fulfil the requirements for efficiency according to (EU) 2019/1781. All motors for explosive dust as described below are IE3 efficient motors. This can be also seen in the motor type like 63SP/4. The "P" is the abbreviation for "premium efficiency".

CCC Ex conducting and non conducting dust NORD abbreviation **C2D**

1500 r/min 50 Hz		230/400 V & 400/690 V 4-pole						Ex tb IIIC T 125°C Db				
Type	P _N	n _N	M _N	I _N	I _N	cos φ	η**	M _A /M _N	M _K /M _N	I _A /I _N	J	kg
	[kW]	[r/min]	[Nm]	230/400 V [A]	400/690 V [A]	φ	4/4xP _N [%]				[kgm ²]	[kg]
63 SP/4	0,12	1342	0,85	0,71/0,41		0,70	64,8	2,7	2,5	3,5	0,00024	3,8
63 LP/4	0,18	1373	1,25	1,00/0,58		0,66	69,9	3,2	3,1	4,0	0,00033	4,7
71 SP/4	0,25	1408	1,70	1,21/0,70		0,73	73,5	3,2	3,2	5,5	0,00086	6,1
71 LP/4	0,37	1397	2,53	1,61/0,93		0,78	77,3	2,8	2,8	5,3	0,00110	7,2
80 SP/4	0,55	1402	3,75	2,46/1,42		0,75	81,4	2,6	2,8	4,9	0,00145	9,7
80 LP/4	0,75	1414	5,06	3,08/1,78		0,75	83,7	3,0	3,1	5,8	0,0019	10,2
90 SP/4	1,10	1429	7,35	4,24/2,45		0,79	85,0	3,6	4,0	7,2	0,0034	15,1
90 LP/4	1,50	1414	10,1	5,61/3,24		0,81	85,3	3,3	3,5	6,8	0,0039	15,4
100 LP/4	2,20	1460	14,4	7,79/4,50		0,81	88,1	2,6	3,9	8,1	0,0081	24,5
100 AP/4	3,00	1454	19,7	10,8/6,25	6,23/3,60	0,81	88,1	2,4	3,6	7,7	0,0081	27,4
112 MP/4	4,00	1440	26,5	13,7/7,94	7,91/4,57	0,84	88,6	3,3	3,5	8,3	0,014	35,5
132 SP/4	5,50	1465	35,8	19,5/11,2	11,2/6,46	0,79	90,9	3,8	4,1	9,7	0,032	55
132 MP/4	7,50	1458	49,1	26,8/15,4	15,4/8,91	0,79	90,4	3,8	4,2	8,8	0,035	62
160 SP/4	9,20	1474	59,6	29,4/17,0	16,9/9,76	0,86	91,0	2,9	3,3	9,5	0,067	93
160 MP/4	11,0	1467	71,6	35,3/20,4	20,3/11,7	0,85	91,4	2,9	3,4	9,4	0,067	93
160 LP/4	15,0	1467	97,6	47,6/27,5	27,3/15,8	0,87	92,3	3,8	4,3	9,9	0,092	122
180 MP/4	18,5	1480	119	60,3/34,8	34,6/20,0	0,83	93,1	3,4	3,8	10,0	0,16	155
180 LP/4	22,0	1475	142	70,7/40,8	40,6/23,4	0,85	93,1	2,8	3,2	8,1	0,16	155

* Version B5, without options 400/690V not available for inverter duty

** Measured value (data on rating plates may deviate, as rating plates have standardised minimum efficiencies).

50 Hz characteristic

87 Hz characteristic

Type plates (examples)

防爆电机 CCC 08F14280

Type SK 90LP/4 C2D TF 2024

3 ~ Mot. | No. 200123456-100 12345678

Th.Cl. 155 (F) S1 Tamb -20...+40° C GYJ20.1216X

Ex tb IIIC T125°C Db IP66 GB/T 3836.1-2021 GB/T 3836.31-2021

Hz	3	20	50	70	r/min	1414
Nm	5,68	10,20	10,10	8,19	kW	1,5
r/min	34	514	1370	1861	V	230/400Δ/Y
kW	0,02	0,55	1,45	1,60	Hz	50
V	33	172	348	351	A	5,61/3,24
A	2,19	3,15	3,53	4,01	cos φ	0,81
					IE3-85,3 %	

15,4 kg

由变频器供电 f_{min} 100 Hz f_{max} 4 kHz PWM

Getriebbau NORD GmbH & Co. KG, 22939 Bargteheide / GERMANY / 意大利 www.nord.com

防爆电机 CCC 08F14280

Type SK 90LP/4 C2D TF 2024

3 ~ Mot. | No. 200123456-100 12345678

Th.Cl. 155 (F) S1 Tamb -20...+40° C GYJ20.1216X

Ex tb IIIC T125°C Db IP66 GB/T 3836.1-2021 GB/T 3836.31-2021

Hz	3	20	87	100	r/min	1414
Nm	5,68	10,20	10,10	10,10	kW	1,5
r/min	34	514	2483	2816	V	230/400Δ/Y
kW	0,02	0,55	2,63	2,99	Hz	50
V	19	99	346	348	A	5,61/3,24
A	3,79	5,40	6,05	6,87	cos φ	0,81
					IE3-85,3 %	

15,4 kg

由变频器供电 f_{min} 100 Hz f_{max} 4 kHz PWM

Getriebbau NORD GmbH & Co. KG, 22939 Bargteheide / GERMANY / 意大利 www.nord.com



Motors for dust explosion protection according to CCC Ex mains operation only

CCC Ex non-conducting dust NORD abbreviation **C2D**

1500 r/min 50 Hz		220/380V & 380/660V 4-pole						Ex tb IIIC T125°C Db				
Type	P _N	n _N	M _N	I _N		cos φ	η**	M _A /M _N	M _K /M _N	I _A /I _N	J	kg
	[kW]	[r/min]	[Nm]	220/380V	380/660V	φ	4/4xP _N				[kgm ²]	[kg]
63 SP/4	0,12	1342	0,85	0,74/0,43		0,70	64,8	2,7	2,5	3,5	0,00024	3,8
63 LP/4	0,18	1373	1,25	1,06/0,61		0,66	69,9	3,2	3,1	4,0	0,00033	4,7
71 SP/4	0,25	1408	1,70	1,28/0,74		0,73	73,5	3,2	3,2	5,5	0,00086	6,1
71 LP/4	0,37	1397	2,53	1,70/0,98		0,78	77,3	2,8	2,8	5,3	0,00110	7,2
80 SP/4	0,55	1402	3,75	2,60/1,50		0,75	81,4	2,6	2,8	4,9	0,00145	9,7
80 LP/4	0,75	1414	5,06	3,24/1,87		0,75	83,7	3,0	3,1	5,8	0,0019	10,2
90 SP/4	1,10	1429	7,35	4,47/2,58		0,79	85,0	3,6	4,0	7,2	0,0034	15,1
90 LP/4	1,50	1414	10,1	5,91/3,41		0,81	85,3	3,3	3,5	6,8	0,0039	15,4
100 LP/4	2,20	1460	14,4	8,21/4,74		0,81	88,1	2,6	3,9	8,1	0,0081	24,5
100 AP/4	3,00	1454	19,7	11,4/6,58	6,56/3,79	0,81	88,1	2,4	3,6	7,7	0,0081	27,4
112 MP/4	4,00	1440	26,5	14,5/8,36	8,32/4,81	0,84	88,6	3,3	3,5	8,3	0,014	35,5
132 SP/4	5,50	1465	35,8	20,4/11,8	11,8/6,8	0,79	90,9	3,8	4,1	9,7	0,032	55
132 MP/4	7,50	1458	49,1	28,2/16,3	16,2/9,38	0,79	90,4	3,8	4,2	8,8	0,035	62
160 SP/4	9,20	1474	59,6	30,8/17,8	17,8/10,3	0,86	91,0	2,9	3,3	9,5	0,067	93
160 MP/4	11,0	1467	71,6	37,1/21,4	21,4/12,3	0,85	91,4	2,9	3,4	9,4	0,067	93
160 LP/4	15,0	1467	97,6	50,1/28,9	28,9/16,7	0,87	92,3	3,8	4,3	9,9	0,092	122
180 MP/4	18,5	1480	119	63,2/36,5	36,5/21,1	0,83	93,1	3,4	3,8	10,0	0,16	155
180 LP/4	22,0	1475	142	74,1/42,8	42,8/24,7	0,85	93,1	2,8	3,2	8,1	0,16	155

* Version B5, without options 380/660V not available for inverter duty

** Measured value (data on rating plates may deviate, as rating plates have standardised minimum efficiencies).

Dust explosion protection

防爆电机

Type SK 90LP/4 C2D TF		2024
3 ~ Mot. No. 200123456-100		12345678
Th.Cl. 155 (F)	S1	Tamb -20...+40° C
Ex tb IIIC T125°C Db IP66 GB/T 3836.1-2021 GB/T 3836.31-2021		
Hz		r/min 1414
Nm		kW 1,5
r/min		V 220/380Δ/Y
kW		Hz 50
V		A 5,91/3,41
A		cos φ 0,81
		IE3-85,3 %
15,4 kg		

Getriebebau NORD GmbH & Co. KG, 22838 Bargteheide / GERMANY / 意大利 www.nord.com

Type plates (examples)

Dust Explosion protection „CCC Ex“



Motor energy efficiency: Premium IE3

CCC Ex non conducting dust NORD abbreviation **C3D**

Dust explosion protection

1500 r/min 50 Hz		230/400 V & 400/690 V 4-pole								Ex tc IIIC T 125°C Dc				
Type	P _N	n _N	M _N	I _N		cos φ	η**			M _A /M _N	M _K /M _N	I _A /I _N	J	
	[kW]	[r/min]	[Nm]	230/400 V	400/690 V	φ	1/2xP _N	3/4xP _N	4/4xP _N				[kgm ²]	[kg]
				[A]	[A]		[%]	[%]	[%]					*
63 SP/4	0,12	1342	0,85	0,71/0,41		0,70	58,3	64,7	66,4	2,7	2,5	3,5	0,00024	3,8
63 LP/4	0,18	1373	1,25	1,00/0,58		0,66	62,2	65,6	69,9	3,2	3,1	4,0	0,00033	4,7
71 SP/4	0,25	1408	1,70	1,21/0,70		0,73	68,2	73,0	73,5	3,2	3,2	5,5	0,00086	6,1
71 LP/4	0,37	1397	2,53	1,61/0,93		0,78	72,8	76,7	77,3	2,8	2,8	5,3	0,00110	7,2
80 SP/4	0,55	1402	3,75	2,46/1,42		0,75	79,5	81,8	81,4	2,6	2,8	4,9	0,00145	9,7
80 LP/4	0,75	1414	5,06	3,08/1,78		0,75	83,7	84,7	83,7	3,0	3,1	5,8	0,0019	10,2
90 SP/4	1,10	1429	7,35	4,24/2,45		0,79	84,7	86	84,1	3,6	4,0	7,2	0,0034	15,1
90 LP/4	1,50	1414	10,1	5,61/3,24		0,81	86,6	86,3	85,3	3,3	3,5	6,8	0,0039	15,4
100 LP/4	2,20	1460	14,4	7,79/4,50		0,81	88,7	89,6	86,7	2,6	3,9	8,1	0,0081	24,5
100 AP/4	3,00	1454	19,7	10,8/6,25	6,23/3,60	0,81	88,4	88,8	87,7	2,4	3,6	7,7	0,0081	27,4
112 MP/4	4,00	1440	26,5	13,7/7,94	7,91/4,57	0,84	88,9	89,2	88,6	3,3	3,5	8,3	0,014	35,5
132 SP/4	5,50	1465	35,8	19,5/11,2	11,2/6,46	0,79	90,6	91,5	89,6	3,8	4,1	9,7	0,032	55
132 MP/4	7,50	1458	49,1	26,8/15,4	15,4/8,91	0,79	90,2	90,5	90,4	3,8	4,2	8,8	0,035	62
160 SP/4	9,20	1474	59,6	29,4/17,0	16,9/9,76	0,86	90,4	91,1	91,0	2,9	3,3	9,5	0,067	93
160 MP/4	11,0	1467	71,6	35,3/20,4	20,3/11,7	0,85	91,6	92,0	91,4	2,9	3,4	9,4	0,067	93
160 LP/4	15,0	1467	97,6	47,6/27,5	27,3/15,8	0,87	92,3	92,8	92,1	3,8	4,3	9,9	0,092	122
180 MP/4	18,5	1480	119	60,3/34,8	34,6/20,0	0,83	92,4	93,1	92,6	3,4	3,8	10,0	0,160	155
180 LP/4	22,0	1475	142	70,7/40,8	40,6/23,4	0,85	93,2	93,5	93	2,8	3,2	8,1	0,160	155

* Version B5, without options

400/690V not available for inverter duty

** Measured value (data on rating plates may deviate, as rating plates have standardised minimum efficiencies).

50 Hz characteristic

87 Hz characteristic

Type plates (examples)

				防爆电机						085/4210	
Type SK 90LP/4 C3D TF		2024		3 ~ Mot. No. 200123456-100		12345678					
Th.Cl. 155 (F)		S1		Tamb -20°...+40°C		GYJ20.1216X					
Ex tc IIIC T125°C Dc		IP55		GB/T 3836.1-2021		GB/T 3836.31-2021					
N E T E R D U T Y	Hz	3	20	50	70	r/min	1414				
	Nm	5,68	10,20	10,10	8,19	kW	1,5				
	r/min	34	514	1370	1861	V	230/400 Δ/Y				
	kW	0,02	0,55	1,45	1,60	Hz	50				
	V	33	172	348	351	A	5,61/3,24				
	A	2,19	3,12	3,53	4,01	cos φ	0,81				
15,4 kg						IE3		85,3%			
由变频器供电		f _{min} 100 Hz		f _{p, min} 4 kHz		PWM					
Getfitebau NORD GmbH & Co. KG, 22930 Bargteheide / GERMANY / 德国 www.nord.com											

				防爆电机						085/4210	
Type SK 90LP/4 C3D TF		2024		3 ~ Mot. No. 200123456-100		12345678					
Th.Cl. 155 (F)		S1		Tamb -20°...+40°C		GYJ20.1216X					
Ex tc IIIC T125°C Dc		IP55		GB/T 3836.1-2021		GB/T 3836.31-2021					
N E T E R D U T Y	Hz	3	20	87	100	r/min	1414				
	Nm	5,68	10,20	10,10	10,10	kW	1,5				
	r/min	34	514	2483	2816	V	230/400 Δ/Y				
	kW	0,02	0,55	2,63	2,99	Hz	50				
	V	19	99	346	348	A	5,61/3,24				
	A	3,79	5,40	6,05	6,87	cos φ	0,81				
15,4 kg						IE3		85,3%			
由变频器供电		f _{min} 100 Hz		f _{p, min} 4 kHz		PWM					
Getfitebau NORD GmbH & Co. KG, 22930 Bargteheide / GERMANY / 德国 www.nord.com											

Attention



C2D and C3D motors which are operated on the inverter can only be selected with a voltage of 230/400V.

The motors may only be operated at an ambient temperature between -20°C and +40°C.

For other ambient temperatures, please contact NORD.



Motor energy efficiency: Premium IE3

CCC Ex non conducting dust NORD abbreviation **C3D**

1500 r/min 50 Hz		220/380V & 380/660V 4-pole						Ex tc IIIC T125°C Dc				
Type	P _N	n _N	M _N	I _N		cos	η**	M _A /M _N	M _K /M _N	I _A /I _N	J	kg
	[kW]	[r/min]	[Nm]	220/380V	380/660V	φ	4/4xP _N				[kgm ²]	[kg]
63 SP/4	0,12	1342	0,85	0,74/0,43		0,70	64,8	2,7	2,5	3,5	0,00024	3,8
63 LP/4	0,18	1373	1,25	1,06/0,61		0,66	69,9	3,2	3,1	4,0	0,00033	4,7
71 SP/4	0,25	1408	1,70	1,28/0,74		0,73	73,5	3,2	3,2	5,5	0,00086	6,1
71 LP/4	0,37	1397	2,53	1,70/0,98		0,78	77,3	2,8	2,8	5,3	0,00110	7,2
80 SP/4	0,55	1402	3,75	2,60/1,50		0,75	81,4	2,6	2,8	4,9	0,00145	9,7
80 LP/4	0,75	1414	5,06	3,24/1,87		0,75	83,7	3,0	3,1	5,8	0,0019	10,2
90 SP/4	1,10	1429	7,35	4,47/2,58		0,79	85,0	3,6	4,0	7,2	0,0034	15,1
90 LP/4	1,50	1414	10,1	5,91/3,41		0,81	85,3	3,3	3,5	6,8	0,0039	15,4
100 LP/4	2,20	1460	14,4	8,21/4,74		0,81	88,1	2,6	3,9	8,1	0,0081	24,5
100 AP/4	3,00	1454	19,7	11,4/6,58	6,56/3,79	0,81	88,1	2,4	3,6	7,7	0,0081	27,4
112 MP/4	4,00	1440	26,5	14,5/8,36	8,32/4,81	0,84	88,6	3,3	3,5	8,3	0,014	35,5
132 SP/4	5,50	1465	35,8	20,4/11,8	11,8/6,8	0,79	90,9	3,8	4,1	9,7	0,032	55
132 MP/4	7,50	1458	49,1	28,2/16,3	16,2/9,38	0,79	90,4	3,8	4,2	8,8	0,035	62
160 SP/4	9,20	1474	59,6	30,8/17,8	17,8/10,3	0,86	91,0	2,9	3,3	9,5	0,067	93
160 MP/4	11,0	1467	71,6	37,1/21,4	21,4/12,3	0,85	91,4	2,9	3,4	9,4	0,067	93
160 LP/4	15,0	1467	97,6	50,1/28,9	28,9/16,7	0,87	92,3	3,8	4,3	9,9	0,092	122
180 MP/4	18,5	1480	119	63,2/36,5	36,5/21,1	0,83	93,1	3,4	3,8	10,0	0,16	155
180 LP/4	22,0	1475	142	74,1/42,8	42,8/24,7	0,85	93,1	2,8	3,2	8,1	0,16	155

* Version B5, without options

220/380V and 380/660V not available for inverter duty

** Measured value (data on rating plates may deviate, as rating plates have standardised minimum efficiencies).

C2D	GB/T 3836.1-2021	GB/T3836.31-2021	C3D	GB/T 3836.1-2021	GB/T3836.31-2021
▶ TF	Temperature sensor (Standard)		▶ TF	Temperature sensor (Standard)	
▶ RD	Protection Canopy		▶ RD	Protection Canopy	
▶ WE	2nd shaft end		▶ WE	2nd shaft end	
▶ KB	Condensation drain hole		▶ KB	Condensation drain hole	
▶ B3	Foot-mounted version		▶ B3	Foot-mounted version	
			▶ BRE	Brake	
			▶ FHL	Lockable hand release for brake	

Motor options

防爆电机

Type SK 90LP/4 C3D TF 2024

3 - Mot. No. 200123456 -100

Th.Cl.155(F) S1 Tamb -20...+ 40°C GYJ20.1216X

Ex tb IIIC T125°C Dc IP55 GB/T 3836.1-2021 GB/T 3836.31-2021

Hz		r/min	1414
Nm		kW	1,5
r/min		V	220/380 Δ/Y
kW		Hz	50
V		A	5,91/3,41
A		COS φ	0,81
		IE3 -	85,3%

15,4 kg

Getriebefabrik NORD GmbH & Co. KG, 22939 Bargteheide / Germany / 意大利 www.nord.com

Type plates (example)

Dust explosion protection

Dust Explosion protection



Inverter operation of NORD motors suitable for explosion protection

Continuously usable torques for operation with control cabinet inverters e.g. SK 500E

If a motor is operated on a frequency inverter, the speed of the motor and thus also the speed at which the driving machine is operated, can be changed. It is important not to exceed or fall below the permissible speed limits. Both NORD inverters and the matching motors are monitored by means of a PTC thermistor and switched off if an overtemperature is detected. In order to prevent this and thus enable reliable operation of the machine to be driven, the correct drive selection is fundamental. It should be noted that the permanently usable torque is not constant. Rather, the torque of the motor changes with its speed.

The usable torque also depends on the characteristic curve used, which can be specified in the inverter.

- ▶ 50Hz characteristic: Inverter power corresponds to motor power.
- ▶ 87Hz characteristic: Inverter power is at least 1.7 times higher than the motor power and the motor has a 230/400 V winding.

An optional available cooling fan cools the motor even at low speed. In most cases, this increases the usable torque at frequencies below 25 Hz. However, such a forced cooling fan also increases the length of the drive and is also a cost factor. The usable torques of modern IE3 motors are also quite high at low speeds, which is why the necessity of a forced cooling fan should be critically examined in each case.

The following guide values are intended to provide assistance in drive selection. In many cases, they are the result of interpolation of measured values. The values specified in the B1091-1 manual form the basis and are binding. In addition to B1091, these instructions are fundamental for safe operation. It also contains information on inverter operation and on the requirements for the inverter in the case of third-party products. The information on the usable torque is based on a combination of NORD cabinet inverters with NORD motors. Motor mounted inverters like the SK180E or SK200E series can produce different results. For more information, refer to catalog G4014.

Attention: 2D and 3D motors intended to be used on inverter are 230/400 V only.

Please do not hesitate to contact NORD if you have any questions regarding the selection of drives.

Dust Explosion protection



Example for 50 Hz characteristic

100AP/4 TF /3D or 100AP/4 TF /2D used in combination with cabinet inverter SK500E in the speed range of 300 to 1500 r/min.

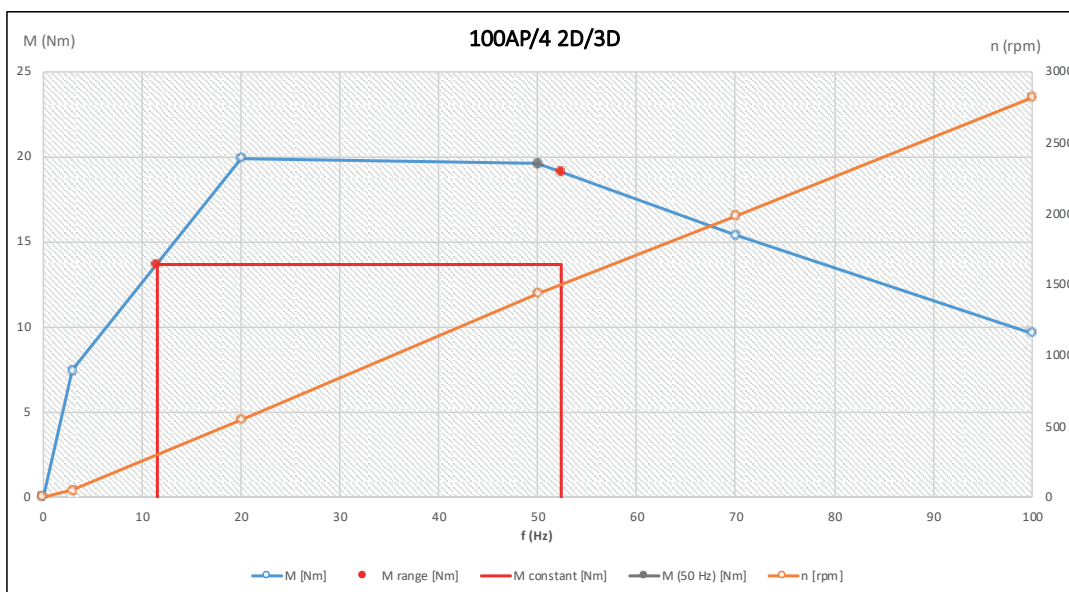

The blue curve show the motor torque, that can be used permanently. At low speed selfventilation and because of this cooling of the motor is low and so torque is less compared to higher speed.

The red curve show the constant torque that can be used permanently in the range of 300 to 1500 rpm.

Results for the motorshaft

Constant Motor torque in the range	13,68 Nm
M_1 (min. frequency)	13,68 Nm
M_1 (50 Hz)	19,60 Nm
M_1 (max. frequency)	19,10 Nm
n_1 (min.)	300 r/min
n_1 (50 Hz)	1435 r/min
n_1 (max.)	1500 r/min
frequency (min.)	12 Hz
frequency (50 Hz)	50 Hz
frequency (max.)	52 Hz



Connection		DOL or Starter		50 Hz characteristic line with 3D or 2D motor in combination with cabinet inverter for example SK500E									
Cooling Regulation range Speed [r/min] Voltage / Frequency Inverter power		IC411		IC411 self-ventilated 1:2,5 600-1500 U/F = constant		IC411 self-ventilated 1:5 300-1500 U/F = constant		IC411 self-ventilated 1:10 150-1500 U/F = constant		IC411 self-ventilated 1:1,73 1500-2600 * U = constant		IC416 forced ventilation** 1:10 150-1500 U/F = constant	
Inverter power				Pinv = Pmot		Pinv = Pmot		Pinv = Pmot		Pinv = Pmot		Pinv = Pmot	
Type	P [kW] at 50 Hz	M _{nominal}	P [kW] at 1500 r/min	M [Nm] in the range	P [kW] at 1500 r/min	M [Nm] in the range	P [kW] at 1500 r/min	M [Nm] in the range	n _{max} [r/min]	P [kW] at n _{max}	M [Nm] in the range	P [kW] at 1500 r/min	M [Nm] in the range
SK 63SP/4	0,12	0,85	0,13	0,80	0,13	0,66	0,13	0,48	2035	0,12	0,49	0,11	0,86
SK 63LP/4	0,18	1,25	0,19	1,12	0,19	0,97	0,19	0,86	2270	0,19	0,79	0,17	1,25
SK 71SP/4	0,25	1,70	0,26	1,65	0,26	1,26	0,26	0,96	2521	0,26	1,00	0,24	1,69
SK 71LP/4	0,37	2,53	0,37	2,38	0,37	1,93	0,37	1,59	2516	0,37	1,39	0,35	2,52
SK 80SP/4	0,55	3,75	0,55	3,35	0,55	2,19	0,55	1,41	2557	0,55	1,60	0,53	3,71
SK 80LP/4	0,75	5,06	0,74	4,56	0,74	3,86	0,74	3,42	2617	0,75	2,23	0,72	5,06
SK 90SP/4	1,10	7,35	1,10	7,12	1,10	4,97	1,10	3,43	2689	1,13	4,27	1,08	7,34
SK 90LP/4	1,50	10,1	1,50	9,59	1,50	8,18	1,50	6,77	2614	1,50	5,08	1,46	10,1
SK 100LP/4	2,20	14,4	2,20	14,0	2,20	9,96	2,20	7,57	2844	2,20	7,47	2,17	14,3
SK 100AP/4	3,00	19,7	3,00	19,1	3,00	13,7	3,00	9,94	2818	3,00	11,2	2,94	19,6
SK 112MP/4	4,00	26,5	3,90	24,6	3,90	18,3	3,90	14,1	2783	4,00	13,4	3,91	26,6
SK 132SP/4	5,50	35,8	5,40	34,5	5,40	25,5	5,40	20,3	2874	5,50	19,4	5,12	35,9
SK 132MP/4	7,50	49,1	7,50	47,1	7,50	37,0	7,50	31,2	2838	7,50	26,6	7,46	49,2
SK 160SP/4	9,20	59,8	8,60	54,5	8,60	39,1	8,60	30,6	2920	9,20	30,9	8,38	48,5
SK 160MP/4	11,0	71,6	10,4	66,2	10,4	53,5	10,4	45,0	2030	11,0	40,6	10,5	55,6
SK 160LP/4	15,0	97,6	13,6	86,5	13,6	69,0	13,6	58,4	2896	12,8	49,8	14,0	80,7
SK 180MP/4	18,5	119	17,6	112	17,6	97,5	17,6	85,5	2935	15,2	61,2	17,1	119,2
SK 180LP/4	22,0	142	20,6	131	20,6	109	20,6	92,2	2927	17,3	70,2	20,4	116,4
SK 225RP/4	30,0	193	30,2	192	30,2	162	30,2	146	2941	28,6	105	29,9	191,0
SK 225SP/4	37,0	238	33,4	213	33,4	195	33,4	173	2953	27,5	120	34,9	222,0
SK 225MP/4	45,0	289	39,3	251	39,3	225	39,3	204	2954	33,1	138	40,2	256,0
SK 250WP/4	55,0	355	48	306	48	272	48	246	2069	46	216	48	310

* Note max. speed!

** Only possible with 3D motors

Dust Explosion protection



Example for 87Hz characteristic

100AP/4 TF /3D or 100AP/4 TF /2D used in combination with cabinet inverter SK500E in the speed range of 300 to 2550 r/min. To use the characteristic the motor winding need to be 230/400V and inverter power need to be 1,73 * motorpower. In this case motor has 3 kW and inverter has 5.5 kW power.

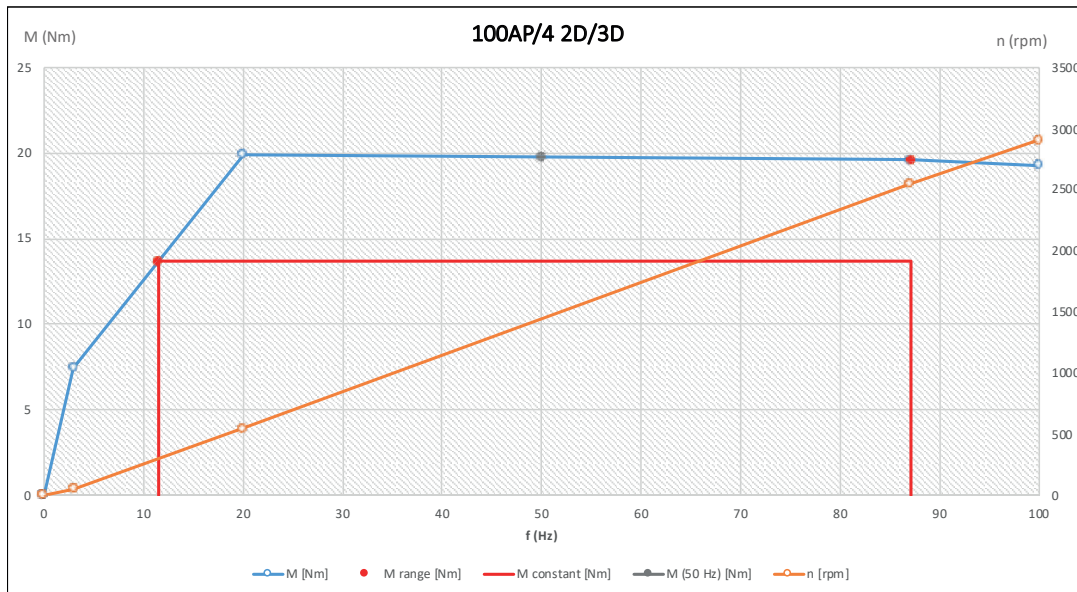

The blue curve show the motor torque, that can be used permanently. At low speed selfventilation and because of this cooling of the motor is low and so torque is less compared to higher speed.

The red curve show the constant torque that can be used permanently in the range of 300 to 2550 r/min.

Results for the motorshaft

Constant Motor torque in the range	13,68 Nm
M_1 (min. frequency)	13,68 Nm
M_1 (50 Hz)	19,77 Nm
M_1 (max. frequency)	19,60 Nm
n_1 (min.)	300 r/min
n_1 (50 Hz)	1444 r/min
n_1 (max.)	2550 r/min
frequency (min.)	12 Hz
frequency (50 Hz)	50 Hz
frequency (max.)	87 Hz



Connection DOL or Starter			87 Hz characteristic line with 3D or 2D motor in combination with cabinet inverter for example SK500E				
Cooling Regulation range Speed [r/min] Voltage / Frequency Inverter power	IC411		IC411 self-ventilated 1:5 300-1500 U/F = constant		IC411 self-ventilated 1:1,73 1500-2600 * U/F = constant		
	–		P _{inv} = P _{mot}		P _{inv} > 1,73* P _{mot}		
Type	P [kW] bei 50 Hz	M _{nominal}	P [kW] at 1500 r/min	M [Nm] in the range	n _{max} [r/min]	P [kW] at n _{max}	M [Nm] in the range
SK 63SP/4	0,12	0,85	0,13	0,66	2740	0,21	0,84
SK 63LP/4	0,18	1,25	0,18	0,97	2769	0,32	1,17
SK 71SP/4	0,25	1,7	0,27	1,26	2816	0,44	1,69
SK 71LP/4	0,37	2,53	0,39	1,93	2793	0,65	2,46
SK 80SP/4	0,55	3,75	0,55	2,19	2805	0,96	3,50
SK 80LP/4	0,75	5,06	0,75	3,86	2830	1,32	4,80
SK 90SP/4	1,1	7,35	1,15	4,97	2859	1,93	7,34
SK 90LP/4	1,5	10,1	1,59	8,18	2816	2,63	10,1
SK 100LP/4	2,2	14,4	2,24	9,96	2923	3,84	14,3
SK 100AP/4	3	19,7	3,1	13,7	2909	5,24	19,6
SK 112MP/4	4	26,5	4	18,3	2893	6,81	25,1
SK 132SP/4	5,5	35,8	5,31	25,5	2940	8,84	32,6
SK 132MP/4	7,5	49,1	7,25	37	2926	12,1	44,6
SK 160SP/4	9,2	59,8	8,37	39,1	2962	14,0	51,6
SK 160MP/4	11	71,6	10,2	53,5	2567	16,4	61,0
SK 160LP/4	15	97,6	13,4	69	2949	22,1	81,2
SK 180MP/4	18,5	119	17,3	97,5	2969	26,5	97,4
SK 180LP/4	22	142	20,3	109	2972	31,4	115
SK 225RP/4	30	193	29,2	162	2973	48,2	177
SK 225SP/4	37	238	31,4	195	2981	42,1	155
SK 225MP/4	45	289	37,8	225	2978	57,0	209
SK 250WP/4	55	355	45,3	272	2589	76	282

* Note max.speed!

The torque for speed < 1500 r/min is equal to those that are shown in the table for 50 Hz characteristic.

Dust Explosion protection



General Information

Planning of motors for NORD decentralised frequency inverters

When planning, it must be noted that the continuously usable motor torque is governed by two factors:

- ▶ By limits which are specific to the motor. These values can be obtained from B1091-1
- ▶ By limits which are specific to the frequency inverter. These values can be obtained from G4014-1

The lower of the two continuously usable motor torques as determined above must always be used for planning purposes.

Category 2D and 3D standard motors supplied by NORD DRIVESYSTEMS comply with the standards DIN EN 60079-0 and DIN EN 60079-31.

The insulation of the windings is designed for operation with frequency inverters. For operation with frequency inverters, the motors are always equipped with triple thermistors as per DIN 44082.

For variable speed drives, the thermistor is the most important protective element to ensure compliance with the maximum surface temperature, which is stated on the type plate of the motor.

Planning of motors with control cabinet inverters from NORD DRIVESYSTEMS, or with inverters which fulfil the following:

Necessary frequency inverter characteristics

- ▶ Only frequency inverters with a vector regulation method which provides load-dependent terminal voltage adjustment in the low speed range may be used.
- ▶ The maximum output voltage of the frequency inverter must not be less than 91 % of the mains voltage which is stated as the rated voltage on the type plate.
- ▶ The frequency inverter must provide $i^2 \cdot t$ monitoring which is adjustable to the rated current for the motor.
- ▶ The pulse frequency of the output stage must be adjustable to 4 kHz or higher.
- ▶ If the inverter does not have an input for evaluation of the thermistor, evaluation must be carried out by a separate triggering device which switches off the inverter. Operation without evaluation of the thermistor is not permitted.
- ▶ Evaluation of the thermistor for motors with ignition protection type tb (Category 2D) must be carried out with an external certified thermistor triggering device with an EU type test certificate.

Thermistor evaluation by the frequency inverter is not permitted. In case of a fault (excessive temperature) the motor and frequency inverter combination must be safely switched off via the external thermistor triggering device.



Motor Option Brake (BRE)

NORD 3D brake motors that can be used in zone 22 are equipped with DC-excited spring pressure brakes. These Ex brakes have the IP class IP66 and are only approved as holding brake. Working brake function as well as emergency stop function is not allowed.

The brakes prevent machines from rotating unintentionally. Therefore the braking torque have to fit to the application. These holding brakes can be switched at maximum 4 times per hour. Special solutions can be developed for applications with more than 4 switching operations, the need for emergency stop properties or use as a working brake. Please inquire.

The braking action is activated on interruption of the current. (idling current principle).

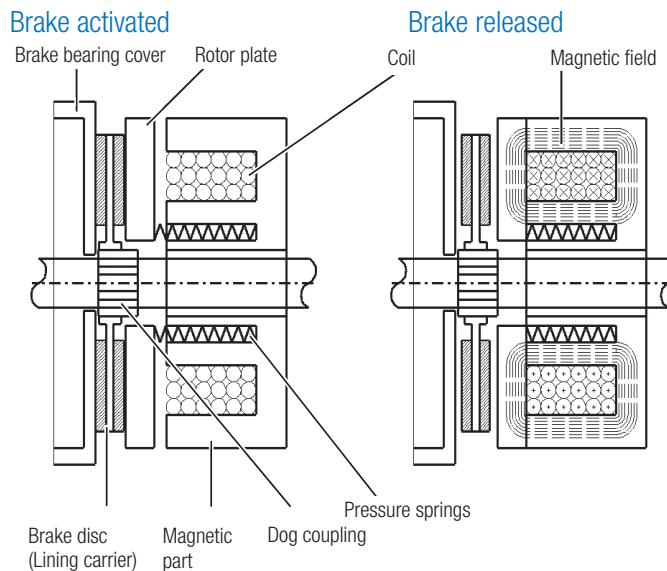

Motors having the additional labelling BRE (e.g. 80LP/4 3D BRE 10) are equipped with a brake and have to be monitored via the installed temperature sensors. The triggering of the temperature sensor of one of the components (motor or brake) must lead to safe shut-down of the entire drive. The PTC resistors of motor and brake must be connected in series. If the motor is operated via a frequency inverter, an external fan (motor option „F“) must be used in the case of stator supply frequencies below 25 Hz. Operation without an external fan in case of stator supply frequencies below 25 Hz is not permitted. For additional information please inform in the NORD motor manual B1091 and in the manual of the brake supplier.

Type code Brake

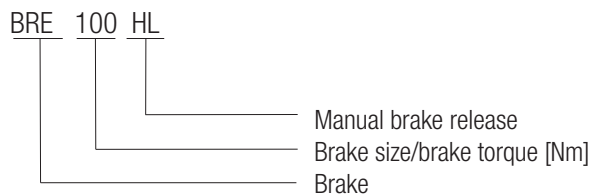

The brake option can be offered for use in the market of the EU, EAWU (EAC Ex) or China (CCC Ex).

Attention: The brake options for these different markets are as follows:

- EU and EAWU: Manual hand release HL or lockable manual brake release FHL
- China: lockable manual brake release FHL

The DC voltage supply of the brake is realized via a rectifier in the motor terminal box or via direct supply with DC voltage. The brake voltage indicated on the name plate must be complied with.

Dust Explosion protection



Standard voltages

Supply voltage (V)	Coil voltage (V)
400	180
230	205
24	24

Permissible brake sizes for Category 3D motors

Size	LKZ	Braking torques [Nm]							
63	SP, LP	5							
71	SP, LP	5							
80	SP	5	10						
80	LP	5	10						
90	SP		10	20					
90	LP		10	20					
100	LP			20	40				
100	AP			20	40				
112	MP			20	40				
132	SP					60			
132	MP					60			
160	SP						100	150	250
160	MP						100	150	250
160	LP						100	150	250
180	MP								250
180	LP								250
225	SP, MP								400
250	WP								400



Motor option forced cooling fan (F) IC416 TEBC

Typical applications for external fans are drives controlled by frequency inverter and operating at low speed over a long period of time. External fans cool the motor independently of the motor speed.

NORD offers separately driven fans for motor sizes 63 to 180. Due to the modified motor cooling, these motors have higher permanently usable motor torques, compared to motors without forced cooling.

More information on page C11 of this catalog and in the manual B1091-1.

The separately driven fan is integrated in the motor fan cover and is suitable for ambient temperatures from -20°C to +40°C and for frequencies of 50Hz or 60Hz.

Execution

- ▶ ISO class F
- ▶ Protection class IP66
- ▶ CE approval ATEX: II 3D Ex tc III C T120°C Dc

All external fans have a separate terminal box. The external fans must be connected separately from the main motor - Conduit entry M16*1,5.

The manufacturer's documentation covers most of the languages that are used in Europe. The manual for the external fan, is supplied with the NORD manuals B1091 and B1091-1.

The dimensions of these Ex fans do not differ from the standard external fans. The overall length and the weight of the external fan depends on the options that may be used in combination, such as brakes or encoders.

External fans of sizes 63-112 have 2 pole motors and those for sizes 132-180 have 4 pole motors.

IE3 motors have less losses and are therefore cooler compared to previously used IE1 and IE2 motors. Low speeds are therefore possible even without an external fan. In such cases the motors are either no longer as efficient or the continuous torque is lower than when using an external fan.

Significant advantages of using an external fan result when the frequency is below 30Hz for the motors: 80SP/4 TF 3D, 80LP/4 TF 3D and 160SP/4 TF 3D. If the frequency falls below 20Hz, the continuously usable torque for all motors with external fans is significantly higher compared to selfventilated motors.

Dust Explosion protection



Dust explosion protection

Photoelectric principle

Motor option Incremental encoder (IG)

Modern drive applications often require speed feedback. Typically, incremental encoders, which convert rotary movement into electrical signals are employed. These signals are read out and processed by frequency inverters or other control devices.

Incremental encoders operate according to the photoelectric method by scanning a disc with alternating lines and spaces. The integrated electronics convert the measuring signals into a digitalised square wave signal according to TTL or HTL logic. Models with various resolutions are available. Standard NORD Ex Encoders feature 1024 or 2048 pulses per rotation.

Motors with incremental encoders, in combination with the motor option external fan (F) and a suitable frequency inverter, offer numerous advantages.

The desired speed can be adjusted very precisely and remains constant even under different loads. This also applies for very low speeds. Especially in connection with the 87Hz characteristic curve, a very wide speed range can be used. Positioning control is also possible.

This option can be used for all ATEX 3D motors Ex tc suitable for inverter operation with a power of 0.12 to 22 kW. A combination with the brake motor option is possible.

Advantages



The encoder option is always offered together with the external fan option.

Principle presentation

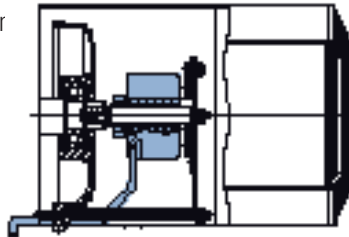

At NORD, the hollow-shaft plug-on rotary encoders are protected under the fan cover, directly on the B-side motor shaft end. This ensures a secure, torsion-free coupling of the encoder.

The electrical connection is made using a ready-for-use cable with an open cable end. The end of the line is sealed with an ESD shield. This protects the encoder from electrostatic voltages.

The connection wiring must be ESD-compliant!

The following variants are available:

NORD Partnr.	Material code	Increments	Signal	Length of the cable
19651610	8.5020.0010.1024.S244.0015.EX	1024	10-30V TTL	1,5 m
19651602	8.5020.0050.1024.S244.0050.EX	1024	10-30V HTL	5,0 m
19651603	8.5020.0050.1024.S244.0015.EX	1024	10-30V HTL	1,5 m
19651604	8.5020.0050.2048.S244.0015.EX	2048	10-30V HTL	1,5 m

Variants with 5V TTL or other deviating specification on request!



Selection of the encoder according to the output logic is determined by the interface of the evaluation electronics. The following conditions apply for NORD frequency inverters:

NORDAC frequency inverter series		Incremental encoder logic	⇒ 
SK500P, SK510P SK530P, SK550P	NORDAC <i>PRO</i> (SK500P)	* HTL mit 10 – 30V Versorgung TTL mit 10 – 30V Versorgung	BU 0600
SK520E, SK530E, SK535E, SK540E, SK545E	NORDAC <i>PRO</i> (SK500E)	TTL mit 10 – 30V Versorgung	BU 0500 / BU 0505
SK200E, SK205E, SK210E, SK215E, SK220E, SK225E, SK230E, SK235E	NORDAC <i>FLEX</i> (SK200E)	* HTL mit 10 – 30V Versorgung	BU 0200
NORDAC LINK	(SK250E - FDS)	* HTL mit 10 – 30V Versorgung	BU 0250

- ▶ The maximum permissible ambient temperature for IE3 Ex tc motors is limited to a maximum of 40°C. Cable length maximum is 50 m.
- ▶ The current consumption under load is a maximum of 100 mA. Pulse frequency is maximum 300kHz.
- ▶ Ex encoder marking: II 3D Ex tc IIIC T135°C Dc IP6X X
- ▶ The encoders are CE-compliant according to:
 - ▶ EMC Directive 2014/30/EU
 - ▶ Directive 2011/65/EU

Pin assignment

Cable	
Colour	Signal
WH	0 V
BN	+ V
GY PK	0 V sens
RD BU	+ V sens
GN	A
YE	A
GY	B
PK	B
BU	0
RD	0

Basic information regarding European gas explosion protection

Explosive gas atmospheres occur in various areas of industry and crafts. They are usually caused by mixtures of oxygen in combination with explosive gases. Electrical and mechanical equipment for use in explosion hazard areas are subject to special national and international standards and guidelines.

Explosion protection prescribes rules which have the objective of protecting people and objects from possible explosion hazards.

Integrated explosion protection specifies that the measures for explosion protection must be carried out in a defined sequence:

- ▶ Rules of conduct to prevent the occurrence of explosive atmospheres
- ▶ Avoidance of ignition of explosive atmospheres
- ▶ Limiting the effect of an explosion to a manageable level

In the design of mechanical and electrical equipment the objective is to prevent ignition or to restrict its effects. For this, the explosion protection regulations come into effect.

The term ATEX, which is often used for explosion protection comes from the initial letters of an older French directive „Atmosphères Explosives“.

Current European explosion protection regulations are based on Directive 2014/34/EU as the successor of the previously valid EU Directive 94/9/EC. This Directive serves for the harmonisation of statutory regulations of member states for devices and protective systems for proper use in explosion hazard areas.

This Directive is also referred to as the “Manufacturer’s Directive” to distinguish it from the “1999/92 EC” directive, which also provides information on improvements to employee health and safety requirements in categories and zones.

Harmonised standards apply in order to meet basic safety and health requirements, some of which are exemplified below:

Standards for electrical devices:

- ▶ DIN EN 60079 - 0 General Regulations
- ▶ DIN EN 60079 - 1 Pressure-resistant Encapsulation „d“
- ▶ DIN EN 60079 - 7 Increased Safety „eb, ec“
- ▶ DIN EN 60079 - 15 Non Sparking „n“

Standards for mechanical devices:

- ▶ DIN EN ISO 80079-36:2016 Basics and requirements
- ▶ DIN EN ISO 80079-37:2016 Protection by Constructional Safety

Equipment group

Directive 2014/34 EU differentiates between two groups of devices:

- ▶ **Group I** devices - indicate equipment which is especially suitable for mining with device categories M1 and M2
- ▶ **Group II** devices - are suitable for use in other areas which may be endangered by an explosive atmosphere

For the majority of applications, the explosion protection data on the type plate begins with „II“, therefore the special features of Group I systems will not be described in further detail here.

EU Directive

Standards

for electrical devices

for mechanical devices

Device groups



Gas Explosion Protection „ATEX“



Standards - for motors

While Directive 2014/34 EU distinguishes between two categories of devices I and II, it is differentiated into Groups I, II and III based on EN 60079-0 standards for motors.

- ▶ **Group I** - features devices mining
- ▶ **Group II** - features devices for gas explosion protection
- ▶ **Group III** - features devices for dust explosion protection

Zone

Zone

The categorisation into zones is made according to the conditions of the workplace – please refer to the statements in Directive 1999/92/EC with regard to the frequency of occurrence of the gas.

Zone 0

Zone 0:

The area in which an explosive atmosphere consisting of a mixture of air and inflammable gases, vapours or aerosols is present permanently, for long periods, or frequently.

Zone 1

Zone 1:

The area in which an explosive atmosphere consisting of air and inflammable gases, vapours or aerosols can occasionally form during normal operation.

Zone 2

Zone 2:

The area in which an explosive atmosphere of air and combustible gases, vapours or aerosols normally does not occur, or only occurs for a short time during normal operation.

Gas explosion protection

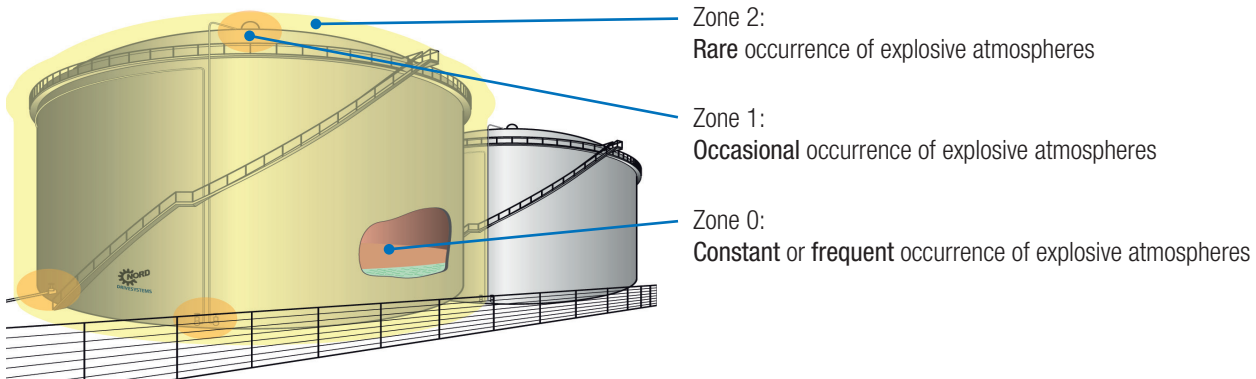

Temperature classes

Flammable atmospheres are divided into temperature classes, which provide information of how high the temperatures of surfaces may be that can come into contact with these gases.

For motors, this typically applies to externally accessible housing and shafts as well as for surfaces inside the motor and the terminal box.

T1 - T6

The temperature classes are divided into T1-T6, whereby in practice the temperature classes T3 and T4 deserve special attention because they are particularly often implemented by motors.

The higher the temperature class, the lower the maximum permissible surface temperature.

This means:

For example, motors of temperature class T4 have temperatures of up to 135 °C as a result of heating during operation, whereas motors in class T3 do not exceed 200 °C.

Type of ignition protection

Depending on the device category and type of risk, small letters in the explosion protection data identify the precise ignition protection type for a device. Encapsulations and constructional measures mainly come into question as methods of protection.

Different solutions are permissible and possible according to the hazard zone.

Gear units

As a rule, a gear unit becomes an Ex-protected system through a safe design, the use of Ex-specific special parts and detailed documentation.

The very informative EN 80079-37 indicates which requirements the technical components must meet.

Motors with pressure-resistant encapsulation „d“ or pressure-resistant encapsulation with terminal boxes with Increased Safety „de“

The idea for protection with „Pressurised encapsulation - Ex d“ consists of housing potential source of ignition in a pressure-resistant casing. The sealing surfaces are bounded by gaps which are resistant to ignition penetration. This safely prevents any explosion inside the housing from spreading to the environment.

For ignition protection class „Ex de“ a terminal box with ignition protection type „Ex e“ is used. The motor itself has ignition protection type „Ex d“.

Pressurised encapsulation motors are assigned to Device Category 2G (Zone 1) and also meet the requirements for Device Category 3G (Zone 2). The rated power does not differ from that of the standard motor.

These motors are often used in cases where inverter operation, brakes, encoders and/or a very high level of safety are required. Typically, pressure resistant encapsulated motors supplied by NORD DRIVESYSTEMS fulfil the requirements for Explosion Group IIC and Temperature Class T4.

Due to the design and compliance with the IE3 energy efficiency, these motors have an aboveaverage dead weight. Especially if motor options such as an external fan or a brake are included as an option. This is particularly important when it comes to IEC B5 motors, that are attached via a standard cylinder. To ensure safe operation, the following motor weights must not be exceeded when using an IEC cylinder:

IEC motor size:	63	71	80	90	100	112	132	160	180	200	225	250	280	315
-----------------	----	----	----	----	-----	-----	-----	-----	-----	-----	-----	-----	-----	-----

max motor weight [kg]:	25	30	50 ¹⁾	50	80 ²⁾	80	100	250 ³⁾	250	350	500	1000 ⁴⁾	1000	1500
------------------------	----	----	------------------	----	------------------	----	-----	-------------------	-----	-----	-----	--------------------	------	------

¹⁾ ≤ 40 kg SK 920072.1, SK 92072.1, SK 0, SK 071.1, SK 0182.1

²⁾ ≤ 60 kg SK 1382NB, SK 1382.1, SK 92372, SK 92372.1, SK 12063, SK 372.1, SK 371.1

³⁾ ≤ 200 kg SK 42, SK 4282, SK 9042.1, SK 42125

⁴⁾ ≤ 500 kg SK 62, SK 72, SK 73, SK 83, SK 93, SK 9072.1, SK 6282, SK 7282, SK 7382, SK 8382, SK9382

In case the motor to be used exceeds the specified weights, changes will be made to the gearbox. This happens automatically when a geared motor is delivered. If the motor is not part of the request and the motor to be used exceed the permissible weight, the request should contain the motor weight.

Areas of application
Explosion group IIC
Temperature class T4



Gas Explosion Protection „ATEX“



Motors versions Increased Safety, type „eb“

For motors of device categories 2G that can be used in Zones 1 and 2, sparking and impermissible temperatures are prevented as per ignition protection type „e“ (Increased Safety). This is achieved by the design of the fans and fan cowls, bearings and terminal boxes.

The motors from our own production have efficiency class IE2 and meet the requirements of the EU as well as those of Russia, Belarus, Armenia, Kazakhstan and Kyrgyzstan. For more information, see pages E1 to E4.

The NORD product range is supplemented by 2, 6 or 8-pole motors as well as motors of efficiency class IE3 which come from another motor manufacturer. If you have any questions, please contact our sales department.

All these motors may only be operated from the mains. Starters are also permitted, the use of a frequency converter is not permitted.

Motors of type of protection Non Sparking Ex n or Increased Safety Ex ec

Category 3G motors for use in Zone 2 and temperature classes T1-T3. These motors do not come from NORD in-house production. Two variants are offered:

- 1: For mains operation in operating mode S1
- 2: For inverter operation with PTC thermistor in operating mode S9. When selecting a motor, it must be taken into account that these motors have significantly less torque than a pressure-resistant motor Ex db of the same power. If in doubt, please contact NORD, stating the required torque and the speed adjustment range, in order to select the appropriate motor.

ATEX LABELLING GAS FOR MOTORS

II 2G Ex eb IIC T3 Gb

Gas explosion protection

Labelling and categorisation of explosive environment									
Type of material	Frequency of occurrence of flammable material	Categorisation of explosive environment	Labelling of equipment			EPL - Equipment protection level			
			Device group	Device category					
Gas (vapours, aerosols, etc.)	Constantly or frequently present	Zone 0	II	1G	2G	3G	Ga	Gb	Gc
	Occasionally present	Zone 1	II						
	Rarely present (short periods)	Zone 2	II						

Type of ignition protection for electrical devices				
Protection principle	Type of ignition protection	Identification	Use in zone	Standard
Pressure-resistant encapsulation	Contains any explosion within the motor housing	de or d	1 and 2	EN60079-1
Increased safety (EPL Gb)	Avoidance of high temperatures and sparks	eb	1 and 2	EN60079-7
Increased safety (EPL Gc)	Avoidance of high temperatures and sparks	ec	2	EN60079-7

Explosion Groups and temperature classes						
Explosion Group Gas			Examples (not complete) for gases, depending on explosion Group and temperature class			
IIA	IIB	IIC	Acetone, ethane, benzene, methane, propane	Ethyl alcohol, n-butane	Heating oil, petrol and diesel fuels	Acetaldehyde Ethyl ether
			Town gas (natural gas)	Ethylene	Hydrogen sulphide	
			Hydrogen	Acetylene		
			T1 <450 °C			
			T2 <300 °C			
			T3 <200 °C			
			T4 <135 °C			

Gas explosion protection

ATEX LABELLING GAS FOR GEAR UNITS

II 2G Ex h IIC T3 Gb

Labelling and categorisation of explosive environment						
Type of material	Frequency of occurrence of flammable material	Categorisation of explosive environment	Labelling of equipment			EPL - Equipment protection level
			Device Group	Device Category		
Gas (vapours, aerosols, etc.)	Constantly or frequently present	Zone 0	I			
	Occasionally present	Zone 1	II	1G		Ga
	Rarely present (short periods)	Zone 2	II		2G 3G	Gb Gc

Ex h Labelling of mechanical devices comply with DIN EN ISO 80079-36

Drive dimensioning

Our customers' applications present a wide variety of requirements for ATEX-compliant operation. We are pleased to consider this in the design of the drive unit in order to contribute to the safe and reliable operation of plant and machinery.

Documentation of special requirements is made on the type plate of the gear unit - see Section „Explosion Protected Gear Units in General“ or in the special documentation enclosed.

Explosion Groups and temperature classes						
Explosion Group Gas			Examples (not complete) for gases, depending on explosion Group and temperature class			
IIA	IIB	IIC	Acetone, ethane, benzene, methane, propane	Ethyl alcohol, n-butane	Heating oil, petrol and diesel fuels	Acetaldehyde, ethyl ether
			Town gas (natural gas)	Ethylene	Hydrogen sulphide	
			Hydrogen	Acetylene		
			T1 <450 °C			
			T2 <300 °C			
			T3 <200 °C			
			T4 <135 °C			



Ex eb Motors Successor of the Ex e Motors

NORD supplies modern Ex eb motors from its own production, which comply with energy efficiency class IE2.

In many cases, due to their high efficiency and modern design, the commonly used reduction of the rated power is not necessary. These motors have type test certification from the PTB (Physikalisch-Technische Bundesanstalt).

NORD DRIVESYSTEMS explosion protected motors have the following type codes:

PTB Certificates

Type code

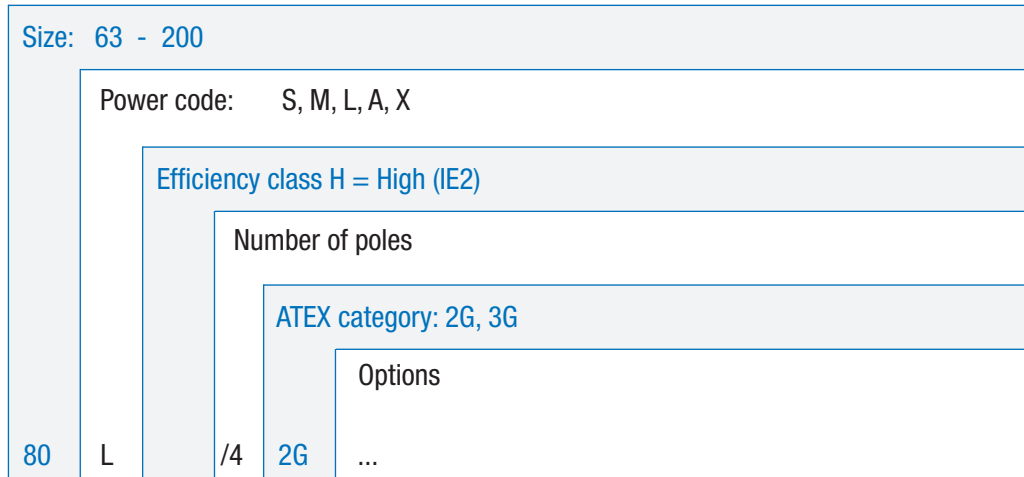

Gas explosion protection

The Ex e motors listed comply with temperature classes T1, T2 and T2.

These motors may not be operated with frequency inverters.

Use of a suitable soft starter is permissible. The permissible ambient temperature or cooling air temperature for NORD Ex e and Ex n motors is between -20°C and +40°C.

These motors have the following features:

- ▶ Housing material: Aluminium
- ▶ Protection class: IP55
- ▶ Insulation class: F
- ▶ Fan cowl material: Metal
- ▶ Fan material: Plastic; above Size 132 metal
- ▶ Type plate material: Stainless steel (V2A)
- ▶ Cable gland:

63, 71:	1 x M25x1.25 II brass
80, 90:	1 x M25x1.5 II brass
100, 112:	1 x M32x1.5 II brass
132:	1 x M32x1.5 II brass
160, 180:	1 x M40x1.5 II brass
- ▶ Blind plugs:

63, 71:	3 x M25x1.25 & 2 x M12x1.5 II brass
80, 90:	3 x M25x1.5 & 2 x M12x1.5 II brass
100, 112:	3 x M32x1.5 & 2 x M12x1.5 II brass
132:	3 x M32x1.5 & 2 x M12x1.5 & 2 x M16x1.5 II brass
160, 180:	1 x M40x1.5 & 2 x M12x1.5 & 2 x M16x1.5 II brass

Temperature classes

Notice
Not permitted for use
with frequency
inverters Features

Features



Gas Explosion protection „ATEX“



Ex eb Motors

II 2G Ex eb IIC T3 Gb

Type	P_N	n_n	M_N	I_N		$\cos \varphi$	η	M_A/M_N	M_V/M_N	I_A/I_N	J	$\overset{\text{kg}}{\square}$	Zeit t_E	Zeit t_E
	[kW]	[rpm]	[Nm]	230/400 V	400/690 V		4/4xP _N [%]				[kgm ²]	* [kg]	T1/T2 [s]	T3 [s]
63SH/4 2G	0,12	1312	0,87	0,76/0,44	0,44/0,25	0,73	59,1	2,20	2,26	2,8	0,00024	3,8	90/90	80
63LH/4 2G	0,18	1313	1,31	1,06/0,61	0,61/0,35	0,70	64,7	2,67	2,72	3,2	0,00033	3,6	73/73	64
71SH/4 2G	0,25	1391	1,72	1,26/0,73	0,73/0,42	0,73	68,5	2,68	2,93	4,5	0,00086	4,9	59/59	53
71LH/4 2G	0,37	1413	2,50	1,81/1,05	1,05/0,61	0,70	72,7	3,10	3,40	4,9	0,00110	7,2	34/34	30
80SH/4 2G	0,55	1415	3,71	2,86/1,65		0,66	77,1	3,20	3,20	4,8	0,0014	8,0	45/45	40
80LH/4 2G	0,75	1400	5,12	3,55/2,05	2,05/1,18	0,68	79,6	3,00	3,10	4,9	0,0019	9,0	45/45	31
90SH/4 2G	1,10	1424	7,37	5,00/2,90	2,88/1,66	0,70	81,4	3,10	3,50	5,8	0,0034	12,0	24/24	21
90LH/4 2G	1,50	1425	10,0	7,53/4,35		0,65	83,6	3,30	3,50	5,6	0,0039	15,0	17/17	9
100LH/4 2G	2,20	1445	14,5	10,0/5,80	5,80/3,35	0,71	84,3	3,70	4,30	7,1	0,0075	21,0	18/18	13
100AH/4 2G	3,00	1450	19,8	12,6/7,30	7,30/4,21	0,76	85,5	2,40	3,60	6,5	0,0081	25,0	10/10	9
112MH/4 2G*	3,60	1444	23,8	13,9/8,00	8,00/4,62	0,77	86,2	3,44	4,00	8,3	0,014	28,0	14/14	6
132SH/4 2G	5,50	1460	36,0	20,8/12,0	12,0/6,93	0,77	87,7	3,10	3,50	7,7	0,032	42,0	14/14	9
132MH/4 2G*	7,50	1460	49,0	29,1/16,8	16,8/9,70	0,74	88,7	3,30	3,90	8,1	0,035	55,0	10/10	5
160MH/4 2G*	11,0	1470	71,5	39,0/22,5	22,5/13,0	0,82	89,8	2,90	3,40	8,6	0,067	93,0	12/12	5
160LH/4 2G	13,5	1470	87,7	45,9/26,5	26,5/15,3	0,85	90,4	3,32	3,85	9,53	0,092	122	14/14	6
180MH/4 2G*	15,0	1480	96,8		30,3/17,5	0,82	90,6	2,90	3,20	8,2	0,13	137	24/24	8
180LH/4 2G*	17,5	1478	113,1		34,5/19,9	0,84	91,0	2,90	3,20	8,2	0,16	155	23/23	7

* 112MH/4 2G, 132MH/4 2G, 160MH/4 2G, 180MH/4 2G and 180LH/4 2G cannot be operated with the integrated temperature sensor (TF) as the sole protection of the motor.

Gas
explosion protection



Thermal protection of the machine by means of direct temperature monitoring of the windings with a thermistor temperature sensor is permitted, if this is certified and stated on the rating plate.

No sole protection
via temperature sensor

Sole protection
via temperature sensor

				Getriebebau NORD GmbH & Co. KG 22939 Bargteheide / GERMANY		0102		08513450	
Type SK 112MH/4 2G TF		2019		3 ~ Mot.		No. 200900815.200		12345678	
TH.Cl. 155(F)		IP55		S1		EN 60034 (H), (A)/EN 60079			
50 Hz		230/400 V Δ/Y		220-242/380-420 V Δ/Y					
13,9/8,0 A		3,60 kW		PTB 14					
COS φ 0,77		1445 min ⁻¹		ATEX 3038/01					
Ex II 2G Ex eb II C T3 Gb		T1		T2		T3		T4	
IA/IN: 8,3		tE [s]:		14		14		6	
IE2=86,2%		230/400 V Δ/Y							
PTC nur als zusätzlicher Schutz zulässig									
Ex									

				Getriebebau NORD GmbH & Co. KG 22939 Bargteheide / GERMANY		0102		08513450	
Type SK 80SH/4 2G TF		2019		3 ~ Mot.		No. 200900815.100		12345678	
TH.Cl. 155(F)		IP55		S1		EN 60034 (H), (A)/EN 60079			
50 Hz		230/400 V Δ/Y		220-242/380-420 V Δ/Y					
2,86/1,65 A		0,55 kW		PTB 08					
COS φ 0,66		1415 min ⁻¹		ATEX 3024/19					
Ex II 2G Ex eb II C T3 Gb		T1		T2		T3		T4	
IA/IN: 4,3		tE [s]:		45		45		40	
IE2=77,1%		230/400 V Δ/Y							
TMS bei Angabe der ta-Zeit nur mit PTC-Auslösegerät nach									
Ex II (2)G PTC DIN 44082 M90 - ta: 31 s									

Notice!

If the time t_A is not indicated on the type plate, the thermistor is not permissible as the sole means of protection.

It is essential that the motor is protected with a motor protection relay which has been approved by a testing facility.

The motor protection relay must be approved for the ignition protection class which is stated on the motor.

Thermistor permissible as the sole protection

Notice
- if t_A is not stated
on the type plate



Gas Explosion protection „ATEX“



Options

NORD DRIVESYSTEMS high efficiency explosion protected motors are available with the following options::

Motor Option	Designation
KB	Condensation hole (closed)
RD	Protection Canopy
TF	Thermistor (Standard)
WE	Second shaft end
IP66	Protection class IP66
SOSP	Special voltages between 104 - 725 V
60Hz	Motor for 60 Hz mains operation

Documentation

The correct operating and installation instructions B1091 are included in every delivery and can be viewed in advance at www.nord.com.

- Available languages

They are available in the following languages:

German, English, French, Spanish, Italian, Serbian, Chinese, Arabic, Brazilian/Portuguese, Dutch, Bulgarian Slovenian, Danish, Greek, Lithuanian, Turkish, Latvian, Romanian, Polish, Russian Slovakian, Czech, Ukrainian, Korean, Japanese, Finnish, Swedish, Hungarian, Croatian and Norwegian.

- Additions to the NORD portfolio

Ex eb motors of energy efficiency IE3, as well as motors with higher power ratings than motors produced by NORD, are purchased separately. The same applies to Ex ec motors which are to be operated on the frequency inverter.



Ex d and Ex de motors

No other explosion protected motors are offered on the market in a greater variety than pressure resistant encapsulated motors.

To make the advantages of this variety accessible to our customers, NORD DRIVESYSTEMS cooperates closely with various manufacturers. This enables us to provide our customers with an attractively priced and technically engaging drive, which realises the customer demand in the best possible way.

The standard version of these motors is as follows:

- ▶ II 2G T4 de IIC T4 Gb as 4-pole version - suitable for mains and inverter operation.

The majority overview of motors does not indicate individual motor features in this catalogue. The following overview presents the range of product and draws attention to special features.

- ▶ Power range: 0.12 - 200 kW (in combination with industrial gear units up to 1000 kW)
- ▶ Number of poles: 2,4,6 and 8 pole as well as switchable poles for 4-2, 6-4, 8-4 and 8-6 pole
- ▶ Cast iron motors in the entire power range and die cast aluminium motors up to 4 kW are possible
- ▶ Energy efficiency class IE3 is standard.

Motor mounting on the gear unit is typically by means of IEC cylinders in use with IEC B5 standard motors for fast delivery.

In many cases, the motor can also be mounted directly on the gear unit. This has advantages in thermally critical cases or to achieve high output speeds and larger adjustment ranges with inverter operation. This version also has advantages for confined installation spaces.

Pressure resistant encapsulated motors are suitable for gas and dust applications in combination with very low ambient temperatures of $< -20^{\circ}\text{C}$ to -40°C .

High ambient temperatures of $>40^{\circ}\text{C}$ $< 60^{\circ}\text{C}$ are also possible. In some cases, this results in a reduction in motor power and / or ISO H insulation.

Further motor options which can be supplied on request:

- ▶ Ex d version with pressure resistant terminal box encapsulation
- ▶ Protective or rain cover "RD"
- ▶ Foot-mounted version
- ▶ Temperature sensor for shut down in case of excess temperature "TF"
- ▶ Additional temperature sensors which switch at lower temperatures and are used as a warning. "2TF"
- ▶ PT100 for direct measurement of the winding temperature "PT100"
- ▶ ISO H
- ▶ Tropicalised installation
- ▶ External fan
- ▶ Special voltage "SOSP"
- ▶ IP66
- ▶ Standstill heating to prevent condensation "SH"
- ▶ Additional explosion protection for Zone 21 or Zone 22 "2D" / "3D"
- ▶ Brakes (various versions for combination with other options) as holding or working brakes "BRE"
- ▶ Incremental encoder "IG"
- ▶ Second shaft end, optionally with hand wheel "WE"
- ▶ Insulated bearings for inverter operation for motor sizes above Size 160

These special motors are marked accordingly with temperature specifications and are equipped with powerful standstill heaters.

Standard version

Motor mounting

- IEC cylinder

Direct motor mounting

- Advantages

Pressure resistant encapsulated motors

$< -20^{\circ}\text{C}$ to -40°C

$>40^{\circ}\text{C}$ $< 60^{\circ}\text{C}$

Options on request



Gas Explosion protection „HazLoc“



Motors for the North American market

- ▶ Class I
- ▶ Division 2 Groups A, B, C, D
- ▶ Temperature Code 165°C
- ▶ Mains operation
- ▶ Operating mode S1
- ▶ IP 55, IP 66,
- ▶ -20°C to +40°C

These are motors which are used in areas in which flammable mixtures of gases or vapours do not occur under normal conditions, but in exceptional cases cannot be ruled out.

These motors are available in efficiency classes High „IE2“ and Premium „IE3“. The motor data is listed for the voltages 230 / 460 V and 332 / 575 V which are particularly important for the USA and Canada ⇒ See type plate.

Options

- ▶ Special voltages between 200 and 600 V
- ▶ Temperature sensor "TF"
- ▶ Temperature monitor "TW" bi-metal switch
- ▶ Protection Canopy "RD"
- ▶ Double fan cowl "RDD"
- ▶ Second shaft end "WE"

Type plates (examples)

										08513530	
Type SK		100 LP/4 CUS ID2 TF								2019	
3 ~ Mot. No.		202592077-100								31261588	
INS F	NEMA	IP 55	S1	AMB 40 °C	TEFC	DP					
60 Hz	230/460	V	YY/Y	EFF IE3-90,0%	CODE L						
7,68/ 3,84 A		3,00 hp		2,20 kW		SF 1,15					
PF 0,79		1770r/min		Class I DIV2 Group A, B, C, D							
				Class II DIV2 Group F&G T3B-165°C							
Hz	r/min	Nm	lb-in	hp	A						
29 kg											
Over Temp Prot-2 Class F											
Getriebebau NORD GmbH & Co. KG, 22939 Bargteheide / GERMANY											
										www.nord.com	

In addition to NORD's listed motors for the North American market, various motors from suppliers can be offered in addition. Please contact us.



Standard Efficiency

230/460 V 4-pole

Class I Division 2

Type	P_N	P_N	n_n	Voltage	Frequency	M		$\cos \Phi$	I_x/I_n	J
	[kW]	[hp]	[rpm]	[V]	[Hz]	[Nm]	[A]			[kgm ²]
63S/4 TF ID2	0,12	0.16	1687	230/460	60	0,68	0,94/0,47	0,54	3,21	0,00021
63L/4 TF ID2	0,18	0.25	1706	230/460	60	1,01	1,18/0,59	0,57	3,58	0,00028
71S/4 TF ID2	0,25	0.33	1710	230/460	60	1,40	1,56/0,78	0,64	3	0,00072
71L/4 TF ID2	0,37	0.50	1715	230/460	60	2,06	1,89/0,94	0,69	4,84	0,00086
80S/4 TF ID2	0,55	0.75	1710	230/460	60	3,07	2,70/1,35	0,71	4,6	0,00109

Premium Efficiency

80 LP/4 TF ID2	0,75	1.00	1730	230/460	60	4,14	3,14/1,57	0,70	6,50	0,0019
90SP/4 TF ID2	1,10	1.50	1740	230/460	60	6,04	4,20/2,10	0,76	8,40	0,0034
90LP/4 TF ID2	1,50	2.00	1730	230/460	60	8,28	5,60/2,80	0,78	7,60	0,0039
100LP/4 TF ID2	2,20	3.00	1770	230/460	60	11,9	7,68/3,07	0,79	9,20	0,0081
112MP/4 TF ID2	3,70	5.00	1755	230/460	60	20,1	13,0/6,50	0,80	9,50	0,014
132SP/4 TF ID2	5,50	7.50	1770	230/460	60	29,7	19,5/9,75	0,77	10,2	0,032
132MP/4 TF ID2	7,50	10.0	1765	230/460	60	40,6	26,7/13,4	0,77	9,60	0,035
160MP/4 TF ID2	11,0	15.0	1770	230/460	60	59,4	35,6/17,8	0,84	8,80	0,067
160LP/4 TF ID2	15,0	20.0	1775	230/460	60	80,7	47,6/23,8	0,85	10,8	0,092

Standard Efficiency

332/575 V 4-pole

Class I Division 2

Type	P_N	P_N	n_n	Voltage	Frequency	M		$\cos \Phi$	I_x/I_n	J
	[kW]	[hp]	[rpm]	[V]	[Hz]	[Nm]	[A]			[kgm ²]
63S/4 TF ID2	0,12	0.16	1702	332/575	60	0,67	0,65/0,37	0,58	3,34	0,00028
63L/4 TF ID2	0,18	0.25	1711	332/575	60	1,01	0,92/0,53	0,55	3,70	0,00028
71S/4 TF ID2	0,25	0.33	1690	332/575	60	1,41	0,90/0,52	0,73	4,33	0,00072
71L/4 TF ID2	0,37	0.50	1710	332/575	60	2,07	1,26/0,73	0,71	4,84	0,00086
80S/4 TF ID2	0,55	0.75	1710	332/575	60	3,07	1,84/1,06	0,71	4,47	0,00109

Premium Efficiency

80LP/4 TF ID2	0,75	1.00	1730	332/575	60	4,14	2,16/1,25	0,70	6,50	0,0019
90SP/4 TF ID2	1,10	1.50	1740	332/575	60	6,04	2,91/1,68	0,76	8,50	0,0034
90LP/4 TF ID2	1,50	2.00	1730	332/575	60	8,28	3,88/2,24	0,78	7,70	0,0039
100LP/4 TF ID2	2,20	3.00	1770	332/575	60	11,9	5,32/3,07	0,79	9,20	0,0081
112MP/4 TF ID2	3,70	5.00	1755	332/575	60	20,1	9,00/5,20	0,80	9,60	0,014
132SP/4 TF ID2	5,50	7.50	1770	332/575	60	29,7	13,5/7,81	0,77	10,2	0,032
132MP/4 TF ID2	7,50	10.0	1765	332/575	60	40,6	18,6/10,7	0,77	9,60	0,035
160MP/4 TF ID2	11,0	15.0	1770	332/575	60	59,4	24,7/14,2	0,84	8,80	0,067
160LP/4 TF ID2	15,0	20.0	1775	332/575	60	80,7	33,0/19,0	0,85	10,8	0,092

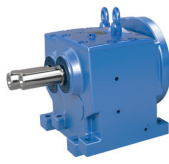

Unlike in many regions of the world, European strict requirements apply to non-electrical equipment such as e.g. Pumps or gearboxes to be used in potentially explosive atmospheres.

The basic requirements for these are defined in Directive 94/9/EC and its successor 2014/34/ EU. To facilitate the demonstration that a device meets these requirements, uniform standards have been adopted at the European level, such as DIN EN ISO 80079-36:2016 and DIN EN ISO 80079-37:2016 were created, which apply in particular to the non-electrical area of explosion protection. These standards influence the conception, construction, testing, labelling and documentation of the devices and equipment. Compliance with these standards ensures that a product can be expected to comply with the essential conditions needed for the Declaration of Conformity.

The level of safety in each Member State is determined by these mandatory regulations for equipment and protective devices intended for use in explosion hazard areas. This facilitates free trade within the EU.

The safe operation of gearboxes and gearmotors depends on the standards-compliant design and two other aspects. Firstly, selection of a gearbox corresponding to the application, taking into account all the factors acting on the gearbox, and secondly proper assembly, operation and maintenance of a drive.

Selection of the gear unit should be made according to the technical explanations in the relevant product catalogues G1000, G1035 and G2000.

The gear unit selections described there must be complied with in order to avoid overloading the gear unit. This must be performed particularly conscientiously.

The selection of a suitable gear unit for the application, especially the necessary operating factor f_b for drive units to be operated in explosion hazard areas also has an influence on safety.

Special technical features of gear units

- ▶ Pressure venting to reduce the pressure inside the gear unit and to protect against dirt
- ▶ In case of a calculated oil temperature $> 84^{\circ}\text{C}$, automatic use of synthetic oil and Viton shaft seals
- ▶ The strength of the housings, shafts and gears correspond to or exceed the minimum values required by the standards
- ▶ In some cases a special housing material may be required. This depends on the method of attachment and the weight of the motor
- ▶ In some cases, special coupling materials (electrically conducting)
- ▶ Largely closed covers for shrink disk versions
- ▶ Possibility of checking the oil level, even for small gear units



„ATEX“ Explosion protected gear units“

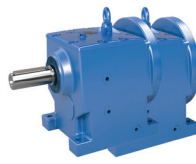

Available gear unit types

Helical gear units (Catalogue G1000)

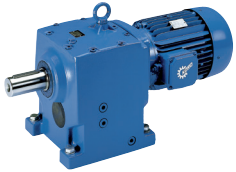

✓ Foot or flange mounted	
✓ UNICASE housing	
Sizes	11
kW	0,12 – 160
Nm	10 – 26.000
i	1,35:1 – 14.340,31:1

2-stage bevel gear units (Catalogue G1000)



✓ Up to 97% efficiency	
✓ Push-on, foot or flange mounted versions	
✓ Hollow or solid shaft	
✓ UNICASE housing	
✓ Die-cast aluminium housing	
Sizes	5
kW	0,12 – 9,2
Nm	90 – 660
i	3,55:1 – 70:1

Parallel shaft gear units (Catalogue G1000)



✓ Push-on, foot or flange mounted versions	
✓ Hollow or solid shaft	
✓ Compact design	
✓ UNICASE housing	
Sizes	15
kW	0,12 – 200
Nm	65 – 90.000
i	4,03:1 – 6.616,79:1

3-stage bevel gear units (Catalogue G1000)



✓ Up to 95% efficiency	
✓ Push-on, foot or flange mounted versions	
✓ Hollow or solid shaft	
✓ UNICASE housing	
Sizes	11
kW	0,12 – 200
Nm	180 – 50.000
i	8,04:1 – 13.432,68:1

Helical worm gear units (Catalogue G1000)

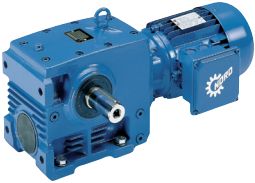

✓ Push-on, foot or flange mounted versions	
✓ Hollow or solid shaft	
✓ UNICASE housing	
Sizes	6
kW	0,12 – 15
Nm	46 – 3.090
i	4,40:1 – 7.095,12:1

SMI worm gear units (Catalogue G1035)

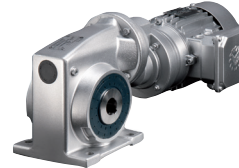

✓ Smooth surface	
✓ Lifetime oil filling	
Sizes	4
kW	0,12 – 1,5
Nm	21 – 246
i	5,00:1 – 540,0:1

NORDBLOC.1 helical gear units (Catalogue G1000)



✓ Foot or flange mounted	
✓ Die-cast aluminium housing (5 sizes)	
✓ UNICASE housing	
✓ Dimensions according to industrial standards	
Sizes	13
kW	0,12 – 37
Nm	55 – 3.300
i	2,10:1 – 456,77:1

SI worm gear units (Catalogue G1035)

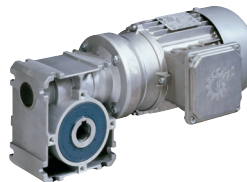

✓ Modular	
✓ IEC versions	
Sizes	5
kW	0,12 – 4,0
Nm	21 – 427
i	5,00:1 – 3.000,00:1

Explosion protected gear units

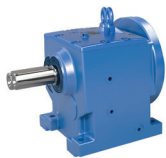

To enable selection according to the application, NORD recommends that the following enquiry form is used



General enquiry form



Company: _____

Customer number: _____

Town/Postcode/Country: _____

Contact: _____

E-mail address: _____

Phone: _____





Please send the enquiry directly to your local NORD contact.

See homepage:
www.nord.com
 (NORD → Sales)



Reference: _____

Date: _____

 Helical gear units* G1000/G2000	 Parallel shaft gear units* G1000	 Bevel gear units* G1000	 Worm gear units G1000/G1035
Geared motors	Adapter for IEC/NEMA motor/servo*	Stand-alone motor (M7000)	
W - Type (free drive shaft): External force: Axial F _{A1} : _____ [N] Radial F _{R1} : _____ [N]; Leverage on shaft collar: _____ [mm]			
Type according to catalogue: _____		Pcs.: _____	

Parameters specific to the gear unit	Frequency inverter operation
Output speed n ₂ at mains frequency: _____ [rpm]	Control cabinet inverters Motor-mounted inverter
Output torque M ₂ : _____ [Nm]	Adjustment range from: _____ [Hz] to _____ [Hz]
Speed ratio i: _____	Speed from n ₁ : _____ [rpm] to _____ [rpm]
Installation position (M1 – M6): _____	Constant torque within adjustment range: _____ [Nm]
Flange: B14 B5 Ø _____ [mm]	Characteristic curve: 50 Hz 70 Hz 87 Hz 100 Hz
Hollow shaft Solid shaft Ø _____ x _____ [mm]	Rotary encoder*: Incremental Absolute
Operating factor f _B : _____	Generating mode: Recovered Power _____ [kW]
Required min. bearing life according to L10h: _____ [h]	Outline conditions
Forces on output: Axial F _{A2} : _____ [N]	Ambient temperature: min. _____ to max. _____ [°C]
Radial F _{R2} : _____ [N] Leverage on shaft collar: _____ [mm]	Max. relative humidity RH: _____ [%]
Bearings: normal VL VL2 VL3 AL	Max. installation altitude (if > 1,000 m): _____ [m]
Bevel gear and worm gear units: A/B side for flange/shaft*	Internal External Contact with water* Exposure to direct sunlight
Oil type: Mineral Synth. Food grade Bio-degradable	Other (dust/dirt/aggressive media; mech./chem.)*
Special oil: _____	ATEX
Parameters specific to the motor	Gas explosion protection
Rated power P ₁ : _____ [kW]	Dust explosion protection
Rated speed n ₁ : _____ [rpm]	Zone 1 Ex II 2G Zone 21 Ex II 2D
Temperature sensor (TF) Bi-metal temperature monitor (TW)	Zone 2 Ex II 3G Zone 22 Ex II 3D
Mains voltage: _____ [V] Mains frequency: _____ [Hz]	Ex e II T3 Non-conducting dust
Efficiency class: IE1 IE2 IE3 IE4	EEx de IIC T4 Conducting dust
Painting/ Surface treatment	Painting/ Surface treatment
Protection class: IP55 (Standard) IP _____	Without 1.0 2.0 (Standard) 3.0 3. _____
Operating mode: S1 (Standard) S _____*	nsd tuPH (only for aluminium housings)
Switching frequency: _____ [cycles/h]	Colour (RAL): Blue (5010) Grey (7031)
Rel. switch-on time: _____ [%] Back stop (RLS)	Special colour (RAL No. / Colour): _____
Ventilation: Standard External (F) Without (OL)	Remarks
Terminal box position: _____ Cable entry: _____	
Parameters specific to brake	
Braking torque M _B : _____ [Nm] Manual release (HL)	
Brake/coil voltage: _____ [V]	
Holding/emergency brake Service brake	
Documentation operation and maintenance instruction (language abbreviation according to ISO 639-1):	
DE BG ZH CS DA ES FI FR EN EL HU IT NL NO PL PT RU SV SK LV RO	

*Please add details in the remarks - Getriebebau NORD GmbH & Co. KG | Getriebebau-Nord-Str. 1 | D-22941 Bargteheide - DE-0818



„ATEX“ Explosion protected gear units

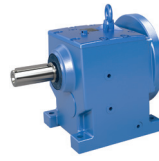

Details on the type plate

For the examination of a drive unit with regard to its suitability for use in explosion hazard areas, in particular the strength of the components as well as heating of the drive are examined individually with regard to the intended use. Many of these details are documented directly on the type plate.

Component strength

In particular the following details have a direct influence on the strength of the components:

- ▶ Gear unit type, possible as the result of specification of the operating factor or the minimum bearing life
- ▶ Motor attachment directly or by means of an IEC or NEMA cylinder
- ▶ Output torque
- ▶ Gear ratio in combination with the motor torque
- ▶ Type and dimension of the output shaft
- ▶ Output shaft bearing type
- ▶ Forces and torques acting on the output shaft
- ▶ Braking torque

Temperature calculation

These details are especially important for calculation of the drive temperature:

- ▶ Gear unit type
- ▶ Motor attachment directly or by means of an IEC or NEMA cylinder
- ▶ Presence of a free input shaft (i.e. without attached motor)
- ▶ Speed of rotation of all rotating components
- ▶ Installation orientation - this has a great influence on the oil filling
- ▶ Bearing type
- ▶ Oil type
- ▶ Rated capacity
- ▶ Ventilation of the motor, whose cooling air flow also has an influence on the gear unit
- ▶ Inverter operation
- ▶ Maximum ambient temperature / cooling air temperature
- ▶ Installation altitude
- ▶ Number and type of seals



Many of the customer's details are documented directly on the type plate.

Ex Gear unit type plate

		Getriebbau NORD GmbH & Co. KG 22939 Bargteheide/GERMANY			
Typ SK 12 – IEC63 /2G					
No. _____					
		i _{ges} 72,63		085 22550	
n ₂	18	min ⁻¹ n ₁	1307,34	min ⁻¹ IM	M1
M ₂	96	Nm P ₁	0,18	kW Bj	01/16
FR ₂	3,35	kN FR ₁		T _u	-10/+40 °C
FA ₂	4,00	kN		x _{R2}	50 mm
Oil	CLP 220 / 0,25l			MI	24000 h
		II 2G Ex h IIC T4 Gb			

Explanation of the type plate

Abbreviations	Unit	Designation	⇒ B2000 Section
Type	-	NORD gear unit type	
No.	-	Serial number	
iges	-	Overall gear unit ratio	
n ₂	min-1	Rated speed of gear unit output shaft*	
n ₁	min-1	Rated speed of the gear unit drive shaft or the drive motor*	
IM	-	Version (installation orientation)	6.1
M ₂	Nm	Max. permissible gear unit output shaft torque	
P ₁	kW	Max. permissible drive power or motor power	
Bj	-	Year of manufacture	
FR ₂	kN	Max. permissible transverse force on the gear unit output shaft	3.9
FR ₁	kN	Max. permissible transverse force on the gear unit drive shaft for option W	3.9
T _u	°C	Permissible ambient temperature for the gear unit	
FA ₂	kN	Max. permissible axial force on the gear unit output shaft	3.9
	kg	Total weight	3.8
MI	h	Interval for general overhaul of the gear unit in operating hours or according to the specification of the dimensionless maintenance class CM	5.2
x _{R2}	mm	Max. dimension for the point of application of the transverse force FR ₂	3.9
Oil	-	Gear unit oil type and quantity (standard designation)	6.2
Last line		ATEX labelling, as per (DIN EN 13463-1):	4.3
		1. Group (always II, not for mines) 2. Category (2G, 3G for gas or 2D, 3D for dust) 3. Marking of non-electrical devices (Ex h) 4. Explosion group if applicable (Gas: IIC, IIB; Staub: IIIC, IIIB) 5. Temperature class (T1-T3 or T4 for gas) or max. surface temperature (e.g. 125 °C for dust) or special max. surface temperature see special documentation (TX) 6. EPL (equipment protection level) Gb, Db, Gc, Dc 7. „X“ means: There is additional special documentation that must be observed.	
S	-	Number of the special documentation, consisting of serial no. / year	

* The maximum permissible speeds are 10 % above the rated speed, if the maximum permissible drive power P₁ is not exceeded.

If the fields FR₁, FR₂, FA₁ and FA₂ are empty, the forces are zero. If the field x_{R2} is empty, the point of application of force FR₂ is central on the output shaft journal (⇒ Section 3.9“)



„ATEX“ Explosion protected gear units

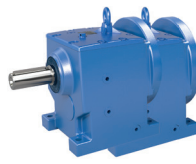

Details from the enquiry form

Examples

(the nameplates shown here serve as an example)

Forces on output: Axial F_{A2} : 500 [N]

Radial F_{R2} : 1000 [N] Lever arm length from shaft shoulder: 120 [mm]

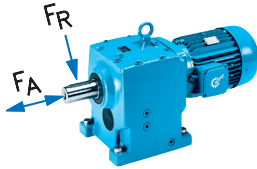

NORD DRIVESYSTEMS		Getriebebau NORD GmbH & Co. KG 22939 Bargteheide/GERMANY		CE	
Typ SK12 VL /2D-90LP/4 2D					
No. _____					
n_2	165	min^{-1}	n_1	1414	min^{-1}
M_2	86,6	Nm	P_1	1,5	kW
F_{R2}	1,0	kN	F_{R1}		kN
F_{A2}	0,5	kN			kN
Oil	CLP 220		MI	7701	h
Ex	II 2D Ex h IIIC T125°C Db		S		
				i_{ges}	8,56
				M	M1
				T_u	-10/+40 °C
				x_{R2}	120 mm

Motor-specific parameters

Delete section

Rated power P_1 : 4.6 [kW]

Rated speed n_1 : 1800 [rpm]

Temperature sensor (TF) Bi-metal temperature monitor (TW)

Mains voltage _____ [V] Mains frequency: 60 [Hz]

NORD DRIVESYSTEMS		Getriebebau NORD GmbH & Co. KG 22939 Bargteheide / GERMANY		CE	
Typ SK 32 - IEC112 /2D					
No. _____					
n_2	183,8	min^{-1}	n_1	1800	min^{-1}
M_2	239	Nm	P_1	4,6	kW
F_{R2}		kN	F_{R1}		kN
F_{A2}		kN	F_{A1}		kN
Oil	CLP 220		MI	9555	h
Ex	II 2D c 125°C X		S		
				i_{ges}	9,80
				M	M1
				T_u	-10/+40 °C
				x_{R2}	mm

Frequency inverter operation

Delete section

Control cabinet inverter Motor-mounted inverter

Adjustment range from: 10 [Hz] to 80 [Hz]

Speed from n_1 _____ [rpm] to _____ [rpm]

Constant torque within adjustment range: 100 [Nm]

Characteristic curve: 50 Hz 70 Hz 87 Hz 100 Hz

NORD DRIVESYSTEMS		Getriebebau NORD GmbH & Co. KG 22939 Bargteheide / GERMANY		CE	
Typ SK 32 - IEC112 /2D					
No. _____					
n_2	233,7	min^{-1}	n_1	2288	min^{-1}
M_2	262	Nm	P_1	4	kW
F_{R2}		kN	F_{R1}		kN
F_{A2}		kN	F_{A1}		kN
Oil	CLP 220		MI	9172	h
Ex	II 2D c 125°C X		S		
				i_{ges}	9,80
				M	M1
				T_u	-10/+40 °C
				x_{R2}	mm

Framework conditions

Delete section

Ambient temperature: min. -10 to max. +50 [°C]

NORD DRIVESYSTEMS		Getriebebau NORD GmbH & Co. KG 22939 Bargteheide / GERMANY		CE	
Typ SK 32 - IEC112 /2D					
No. _____					
n_2	146	min^{-1}	n_1	1430	min^{-1}
M_2	262	Nm	P_1	4	kW
F_{R2}		kN	F_{R1}		kN
F_{A2}		kN	F_{A1}		kN
Oil	CLP 220		MI	9172	h
Ex	II 2D c 125°C X		S		
				i_{ges}	9,80
				M	M1
				T_u	-10/+50 °C
				x_{R2}	mm

Explosion protected gear units



Preventative maintenance

Scheduled and proper maintenance of gear units is especially important for explosion protection as it has a direct impact on safe operation. In particular, operators of Category 2 (2D or 2G) drives for use in Zone 1 or 21 must take expected errors into account.

This includes scheduled replacement of the gear oil as well as regular checks on the oil level – refer to the details in the operating and maintenance manual B2000.

In addition, the bearings and shaft sealing rings must be replaced as a preventative measure depending on the requirements of drive selection and application. Maintenance in case of damage or signs of imminent bearing damage results in a potentially dangerous situation and must be avoided at all costs!

To enable this preventative maintenance, according to a draft version of DIN EN ISO 80079-37:2016, NORD labels its Category 2 gear units with a maintenance interval „MI“. This interval indicates the number of operating hours after which replacement of the bearings and seals is advisable. In association with this, other components of the gear unit are subjected to a visual inspection and are replaced in rare cases.

The maintenance interval assumes use of the gear unit with the rated power / rated torque. Lower powers have a positive effect on the maintenance interval.

Example for a gear unit with a maintenance interval of 24497 hours.

Oil level check

General overhaul

Example

		Getriebebau NORD GmbH & Co. KG 22939 Bargteheide / GERMANY			
Typ SK 22 /2G - 80 LH/4 /2G					
No. _____					
				i _{ges} 24,73	
n ₂	56,71	min ⁻¹	n ₁	1400	min ⁻¹
M ₂	126	Nm	P ₁	0,75	kW
F _{R2}	1	kN	F _{R1}		kN
F _{A2}	0,5	kN	F _{A1}		kN
Oil		CLP 220		MI 24497 h	
		II 2G c T3 X		S	

Explosion protected gear units

On customer's request, it is also possible to specify a maintenance class, which enables the customer to calculate the maintenance interval depending in the period of use per day and the actual average output power. Further details can be found in the operation and maintenance manual B2000.

Maintenance class

		Getriebebau NORD GmbH & Co. KG 22939 Bargteheide / GERMANY			
Typ SK 22 /2G - 80 LH/4 /2G					
No. _____					
				i _{ges} 24,73	
n ₂	56,71	min ⁻¹	n ₁	1400	min ⁻¹
M ₂	126	Nm	P ₁	0,75	kW
F _{R2}		kN	F _{R1}		kN
F _{A2}		kN	F _{A1}		kN
Oil		CLP 220		MI CM=3 h	
		II 2G c T3 X		S	

Example



„ATEX“ Explosion protected gear units



DECLARATION OF CONFORMITY

You can find certificates on the NORD homepage under www.nord.com - Heading DOCUMENTATION / CERTIFICATES



GETRIEBEBAU NORD
Member of the NORD DRIVESYSTEMS Group

Getriebebau NORD GmbH & Co. KG
Getriebebau-Nord-Str. 1, 22941 Bargteheide, Germany, Tel.: +49(0)4532 289 - 0, Fax: +49(0)4532 289 - 2253, info@nord.com

EU Declaration of Conformity
According to EU directive 2014/34/EU Annex VIII

Getriebebau NORD GmbH & Co. KG declares in sole responsibility, that the gear units and geared motors from the following product series Page 1 of 1

<ul style="list-style-type: none"> • Helical gear units Type SK ... • Parallel shaft gear units Type SK ...82, SK ...82.1, SK ...82NB 	<ul style="list-style-type: none"> • Worm gear units Type SK 02..., SK 1S!..., SK 3..., SK 4.... • Bevel gear units Type SK 9.....
---	--

with ATEX labelling  II 2D / II 2G (you can find the specific labellin

are compliant with the following directive:
ATEX directive for products **2014/34/EU** (source of inform

Applied harmonised standards:

DIN EN 1127-1:	
DIN EN ISO 80079-36:	
DIN EN ISO 80079-37:	
DIN EN 60079-0:	

Getriebebau NORD has submitted the documents required as per 2 VIII to the notified body:

DEKRA EXAM GmbH
Dinnendahlstraße 9
44809 Bochum
ID number:0158
Certificate: BVS 04 ATEX

Bargteheide, 01/09/2021

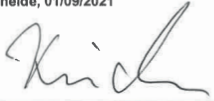
 U. Küchenmeister
Manager

 Tec

Explosion protected gear units



GETRIEBEBAU NORD
Member of the NORD DRIVESYSTEMS Group

Getriebebau NORD GmbH & Co. KG
Getriebebau-Nord-Str. 1, 22941 Bargteheide, Germany, Tel.: +49(0)4532 289 - 0, Fax: +49(0)4532 289 - 2253, info@nord.com

EU Declaration of Conformity
According to EU directive 2014/34/EU Annex VIII

Getriebebau NORD GmbH & Co. KG hereby declares in sole responsibility, that the gear units and geared motors from the following product series Page 1 of 1

<ul style="list-style-type: none"> • Helical gear units Type SK ... • Parallel shaft gear units Type SK ...82, SK ...82.1, SK ..82NB 	<ul style="list-style-type: none"> • Worm gear units Type SK 02..., SK 1S...,SK 12..., SK 13..., SK 3..., SK 4.... • Bevel gear units Type SK 9.....
--	--

with ATEX labelling  II 3D / II 3G (you can find the specific labelling on the nameplate)

are compliant with the following directive:
ATEX directive for products **2014/34/EU** (source of information: L 96, 29.03.2014, p. 309-356)

Applied harmonised standards:

DIN EN 1127-1:	2019
DIN EN ISO 80079-36:	2016
DIN EN ISO 80079-37:	2016
DIN EN 60079-0:	2018

Bargteheide, 01/09/2021

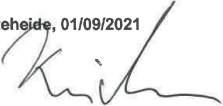
 U. Küchenmeister
Manager

 Dr. O. Sadi
Technical Manager

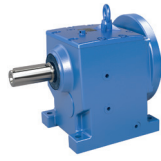

Documentation

Standard	Special Documentation																																		
B2000	<p>Inclined installation orientations</p> <div style="text-align: right;">SK 3282 - IEC 80/90</div> <table border="1" style="margin-top: 10px;"> <tr> <td></td> <td>Entlüftung / Vent</td> </tr> <tr> <td></td> <td>Ölstand / Oil Level</td> </tr> <tr> <td></td> <td>Ölablass / Oil Drain</td> </tr> </table> <table border="1" style="margin-top: 10px; width: 100%;"> <tr> <td>Konfigurationsbauform SAP Sporovetko montazu Konfigurazj SAP Position de montage de configuration SAP Configurazjion position SAP</td> <td>M3</td> </tr> <tr> <td> Grundbauform Pozycja wstawienia Position de montage de base Basic position</td> <td>M3</td> </tr> <tr> <td> Schwenkrichtung Kierunek nachylenia Sense de pivotement Pivoting direction</td> <td>M4</td> </tr> <tr> <td> Schwenkwinkel Kąt nachylenia Angle de pivotement Swivel angle</td> <td>[7]</td> </tr> <tr> <td> Ölfüllmenge Niveau d'huile Oil fill level</td> <td>[1]</td> </tr> <tr> <td>Datum Date</td> <td></td> </tr> <tr> <td>Unterschrift Prose Signature</td> <td></td> </tr> </table> <table border="1" style="margin-top: 10px; width: 100%;"> <tr> <td rowspan="3" style="text-align: center;"> Getriebebau NORD GmbH & Co. KG Getriebebau-Nord-Straße 1 D - 22941 Bargtheide Tel. 04532/289-0 - Fax 04532/289-2253 - www.nord.com </td> <td style="text-align: center;">Schutzvermerk nach ISO 16016 beachten</td> <td style="text-align: center; font-size: 2em;">Atex</td> </tr> <tr> <td> <table border="1" style="width: 100%;"> <tr> <th>Bearb.</th> <th>Datum/Date</th> <th>Name/Name</th> </tr> <tr> <td>Drawn</td> <td>06.08.2018</td> <td>Mirow</td> </tr> </table> </td> <td style="text-align: center;">Sonderdokumentation Special documentation</td> </tr> <tr> <td></td> <td></td> <td style="text-align: center; font-size: 1.5em;">60/18</td> </tr> </table>		Entlüftung / Vent		Ölstand / Oil Level		Ölablass / Oil Drain	Konfigurationsbauform SAP Sporovetko montazu Konfigurazj SAP Position de montage de configuration SAP Configurazjion position SAP	M3	Grundbauform Pozycja wstawienia Position de montage de base Basic position	M3	Schwenkrichtung Kierunek nachylenia Sense de pivotement Pivoting direction	M4	Schwenkwinkel Kąt nachylenia Angle de pivotement Swivel angle	[7]	Ölfüllmenge Niveau d'huile Oil fill level	[1]	Datum Date		Unterschrift Prose Signature		 Getriebebau NORD GmbH & Co. KG Getriebebau-Nord-Straße 1 D - 22941 Bargtheide Tel. 04532/289-0 - Fax 04532/289-2253 - www.nord.com	Schutzvermerk nach ISO 16016 beachten	Atex	<table border="1" style="width: 100%;"> <tr> <th>Bearb.</th> <th>Datum/Date</th> <th>Name/Name</th> </tr> <tr> <td>Drawn</td> <td>06.08.2018</td> <td>Mirow</td> </tr> </table>	Bearb.	Datum/Date	Name/Name	Drawn	06.08.2018	Mirow	Sonderdokumentation Special documentation			60/18
	Entlüftung / Vent																																		
	Ölstand / Oil Level																																		
	Ölablass / Oil Drain																																		
Konfigurationsbauform SAP Sporovetko montazu Konfigurazj SAP Position de montage de configuration SAP Configurazjion position SAP	M3																																		
Grundbauform Pozycja wstawienia Position de montage de base Basic position	M3																																		
Schwenkrichtung Kierunek nachylenia Sense de pivotement Pivoting direction	M4																																		
Schwenkwinkel Kąt nachylenia Angle de pivotement Swivel angle	[7]																																		
Ölfüllmenge Niveau d'huile Oil fill level	[1]																																		
Datum Date																																			
Unterschrift Prose Signature																																			
 Getriebebau NORD GmbH & Co. KG Getriebebau-Nord-Straße 1 D - 22941 Bargtheide Tel. 04532/289-0 - Fax 04532/289-2253 - www.nord.com	Schutzvermerk nach ISO 16016 beachten	Atex																																	
	<table border="1" style="width: 100%;"> <tr> <th>Bearb.</th> <th>Datum/Date</th> <th>Name/Name</th> </tr> <tr> <td>Drawn</td> <td>06.08.2018</td> <td>Mirow</td> </tr> </table>	Bearb.	Datum/Date	Name/Name	Drawn	06.08.2018	Mirow	Sonderdokumentation Special documentation																											
	Bearb.	Datum/Date	Name/Name																																
Drawn	06.08.2018	Mirow																																	
		60/18																																	

Explosion protected gear units

The appropriate operating and installation instructions B2000 are included in every delivery and can be viewed in advance at www.nord.com.

[Documentation](#)

They are available in the following languages:

German, English, French, Spanish, Italian, Serbian, Chinese, Arabic, Brazilian/Portuguese, Dutch, Bulgarian Slovenian, Danish, Greek, Lithuanian, Turkish, Latvian, Romanian, Polish, Russian, Slovakian, Ukrainian, Korean Japanese, Czech, Finnish, Swedish, Hungarian, Croatian and Norwegian.

- Available languages

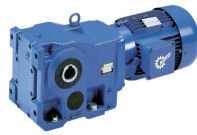

Hybrid mixtures

Both the gear units and motors, which are used in the context of explosion protection, take into account the specific requirements of the respective explosive substance.

For example, gases may penetrate into cavities in the motor or terminal box, which must be taken into account during construction.

Dust, on the other hand, is prevented by IP55 or higher protection from accumulating in the motor in an ignitable concentration, which facilitates the motor design on this point and saves costs.

In contrast, in the case of motors in a dust environment, electrostatic charging may occur more easily, which may result in hazardous corona discharge. In summary, it can be said that the ignition hazards in dust and gas atmospheres differ and result in specific technical solutions.

In rare cases, e.g. in mining, a mixture of flammable dust and flammable gas may occur - so-called hybrid mixtures. In the case of mining, this would typically be a mixture of methane, coal dust and air.

In view of the large number of flammable gases, dust and their resulting mixtures, the potential hazards are extremely numerous and complex.

The selection of a suitable drive can therefore not be made without the precise analysis of the situation on site. It must be acknowledged that a drive which can be used safely in a pure gas or dust atmosphere cannot provide an adequate level of safety in an environment with a hybrid mixture. In this case, the operator or plant constructor has to endeavour to avoid danger in the context of tertiary explosion protection - ie to reduce the effect of a possible explosion.

Currently no standard exists which provides specifications for the technical design of motors or gear units in environments with hybrid mixtures. NORD DRIVESYSTEMS therefore does not offer motors or gear units for this purpose.

For logistical reasons it may be advisable to use a drive unit which can be used in either an explosive gas or dust atmosphere. Here it should be evaluated whether the higher price of the drive is outweighed by the flexibility gained. Such drives are offered by NORD DRIVESYSTEMS in the following combinations: 2G/2D, 2G/3D and 3G/3D.

The type plates of the gear unit and the motor indicate suitability for both gas and dust.

Hybrid mixtures

NORD drives
- 2G/2D, 2G/3D, 3G/3D

Example
- 2G/2D drive

Typeplates
(examples)

Hybrid mixtures

		Getriebebau NORD GmbH & Co. KG 22939 Bargeheide/GERMANY			
Typ	SK52F IEC112 /2G /2D				
No.	085, 22550				
n_2	54	$\text{min}^{-1} n_1$	1435	$\text{min}^{-1} \text{IM}$	26,46
M_2	704	Nm	P_1	4	M1
F_{R2}	kN	F_{R1}	kN	T_u	-20/+40 °C
F_{A2}	kN	x_{z2}	mm	x_{z1}	mm
Oil	CLP PG 220				
	II 2G Ex h IIC T4 Gb				
	II 2D Ex h IIIC T125°C Db				

0158					
D-32008 Herford					
3-Mot.	DEx 132SP/4K		No. XXXXXXXXX		
BVS 14 ATEX E 114 X / IECEx BVS 14.0075 X					
II 2G Ex db eb II CT4 Gb / Ex db eb II CT4 Gb					
or II 2D Ex tb IIIC T135°C Db / or Ex tb IIIC T135°C Db					
I.CI.	F	IP	65	IM	96 kg
V	Hz	kW	A	cos φ	r/min Ia / In
D400	50	5,5	11,1	0,79	1460 7,1
Y690	50	5,5	6,41	0,79	1460 7,1
Cable entries 2xM32x1,5 + 1xM20x1,5 Duty S1-S9					
tA=24s		Artikel Nr.: T132-X0055			
PTC	3-PTC 145°C	Ta = -20/+40°C		IE3=90,3%	

Lackierung

NORD has a variety of paint coating options available in order to protect your investment regardless of the application's environment. Please refer to the table below for details:

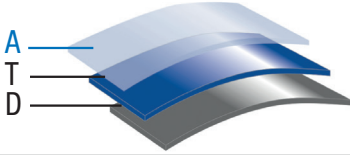
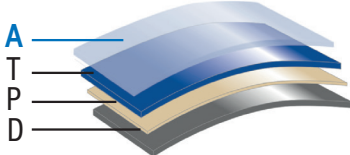
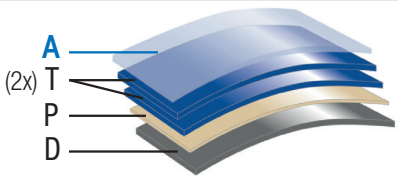
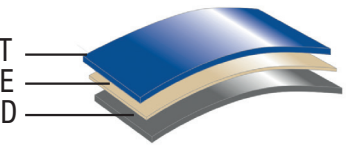
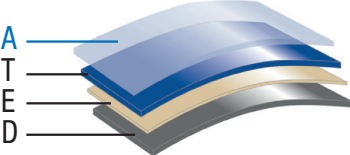
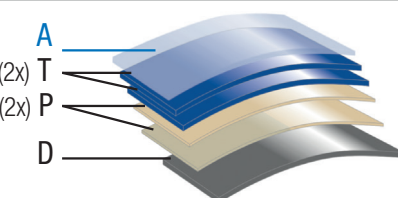
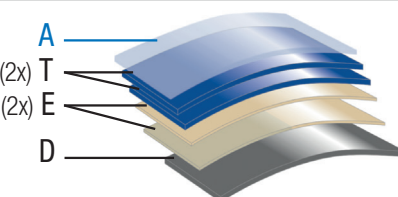
Coating / Field of Application		Class **	Structure	Coating Thickness *
Basic Basic+ Indoor installation. <i>Previously F2</i>		C2		50 - 90 µm
NORD Severe Duty 2 NORD Severe Duty 2+ Indoor installation and protected outdoor installation (i. e. open, unheated halls). <i>Previously F3.0</i>		C2		110 - 150 µm
NORD Severe Duty 3 NORD Severe Duty 3+ Outdoor installation, city and industrial atmosphere with low contamination. <i>Previously F3.1</i>		C3		160 - 200 µm
NORD Severe Chem Duty 3 Normale chemical contamination. <i>Previously F3.4</i>		C3		100 - 140 µm
NORD Severe Food Duty 3 NORD Severe Food Duty 3+ Food packaging areas. <i>Previously F3.5</i>		C3		100 - 140 µm
NORD Severe Duty 4 NORD Severe Duty 4+ Outdoor installation, city and industrial atmosphere with moderate contamination. <i>Previously F3.2</i>		C4		220 - 260 µm
NORD Severe Duty 5 NORD Severe Duty 5+ Outdoor installation, city and industrial atmosphere with high contamination. <i>Previously F3.3</i>		C5		200 - 240 µm
A	Optional clear lacquer coating (+ versions) Coating Thickness + 25 µm	T	2-Component Polyurethane Top Coat	
		E	2-Component EP Zinc Phosphate Primer	
Z	Levelling of contour recesses and gaps with polyurethane-based sealant possible for NSD2, NSD3 and NSD4 included in NSD5	P	2-Component Polyurethane Primer	
		D	Single Component Dip Primer (for cast-iron units only)	

** Comparable to DIN EN ISO 12944-2 classification of ambient conditions

* Protocol of the coating thickness based on ISO 19840 available on request

Painting

The type of coatings on devices that are used in explosive environments is specified by standards. These describe measures to avoid dangers that can arise from electrostatic charges. In device group II (gas), possible brush discharges in particular are taken into account. Therefore, the selection of finishes for explosion protection, e.g. with regard to the use of clear varnish, is limited.

The paint finishes marked below with a tick can be offered for gear motors and motors according to ATEX, IECEx, EACEx and CCCEx.

Painting	Gas	Dust
Without painting	✓	✓
Primed	✓	✓
Basic	✓	✓
Basic +		
NSD2	✓	✓
NSD2+		
NSD3	✓	✓
NSD3+		
NSDC3	✓	✓
NSDF3	✓	✓
NSDF3+		
NSD4	✓	✓
NSD4+		
NSD5	✓	✓
NSD5+		

In device group III (dust), the restrictions with regard to the painting are lower, since the electrostatic discharges act differently on dust-air mixtures compared to gas-air mixtures.

The colors RAL 9006 and RAL 9007 only have the approval for the basic and NSD3 color structures in the gas explosion protection for NORD drives.

All paintwork approved for explosion protection has been tested and found to be suitable. Since this is a complex process, no customer-specific paintwork can be offered that deviates from the paintwork mentioned above. If motors are provided by customers, they must be unpainted.

The subsequent painting of drives painted by NORD for the first time may only be carried out in consultation with NORD or a repair workshop approved for the repair of explosion-proof drives. The valid standards and regulations must be observed.

Cooling systems

Compliance with the maximum permissible temperatures is of great importance in explosion protection. External application-related influences, a high power density in the gear unit, high speeds, as well as gear unit installation with maximum oil level in the gear unit may lead to gear units having to be cooled. For this purpose, NORD offers both water coolers as well as oil/air coolers.

Wasserkühlung

Getriebeoption CC: Gehäusedeckel mit Kühlschlange

An integrated heat exchanger is optionally available for parallel shaft gear units and bevel gear units. The cooling water flows through the heat exchanger, and cools the gear unit. Monitoring of the temperature or the cooling water flow is recommended. As the cooling coil is not located in the oil sump, the NORD water cooling design is very safe (German industrial design registration 20 2005 005 452.6).

Water cooling is also suitable for use in areas with potentially explosive atmospheres (ATEX).

Integrated heat exchanger

NORD water cooling

Parallel shaft gear units	Installation orientation					
	M1	M2	M3	M4	M5	M6
SK 6282 / SK 6382	✓	✓		✓	✓	✓
SK 7282 / SK 7382	✓	✓		✓	✓	✓
SK 8282 / SK 8382	✓	✓		✓	✓	✓
SK 9282 / SK 9382	✓	✓		✓	✓	✓
SK 10382.1 **	✓	✓		✓	✓	✓
SK 11382.1 **	✓	✓		✓	✓	✓

Possible mounting position for water cooling

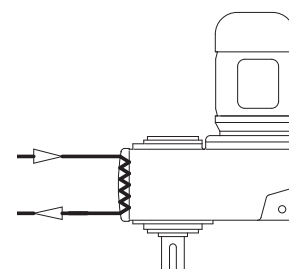

Bevel gear units	Installation orientation					
	M1	M2	M3	M4	M5	M6
SK 9072.1 *	•		✓	✓	•	•
SK 9082.1	•		✓	✓	•	•
SK 9086.1	•		✓	✓	•	•
SK 9092.1	•		✓	✓	•	•
SK 9096.1	•		✓	✓	•	•

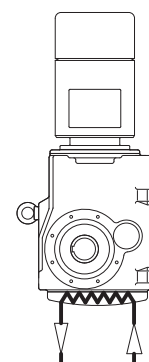

* Only available in versions AF(B), AZ... and VF, VZ ⇒ E104, E105, E133

** In preparation - Supply on request

✓ Full cooling power

• Reduced cooling power

Cooling systems

Oil/Air Cooler

Gear unit option CS2

An oil/air cooler is a separate system which is connected to the gear unit with hoses which cools the oil in the gear unit and therefore directly reduces the surface temperature of the gear unit.

For this, the oil is drawn in by a pump and flows through a heat exchanger. The oil is cooled by an air stream which is generated by a fan. The oil is then returned to the housing from the heat exchanger. The temperature is controlled by a thermostat (PT100).

Temperature monitoring EX-compliant PT100

Temperature monitoring is necessary and is enabled by an Ex-compliant PT100 which is supplied with the system. Depending on the ambient temperature, the cooling power is approx. 5 kW.

Can be used for the following gear units

- ▶ Helical gear units SK62 – SK103
- ▶ Parallel shaft gear units SK6282 – SK11382.1
- ▶ Bevel gear units SK9072.1 – SK9096.1

The cooling system is suitable for

- ▶ II 2G Ex h IIB + H2 T4 Gb
- ▶ II 3D Ex h IIIC T130°C Dc
- ▶ Ambient temperatures (hoses and cooler) in operation
 - Minimum +5°C with 2 m hose length
 - For $\geq +20^\circ\text{C}$ 2 or 4 m hoses can be used
- ▶ Max. ambient temperature +40°C
 - Higher temperatures on request

Planning of this cooling system is always carried out by experienced engineers, who modify the system to the special features of the application and the gear unit which is to be cooled.

Commissioning, Maintenance

Separate special documentation exists, which provides detailed information about the commissioning, operation and maintenance of the system.

Oil cooler

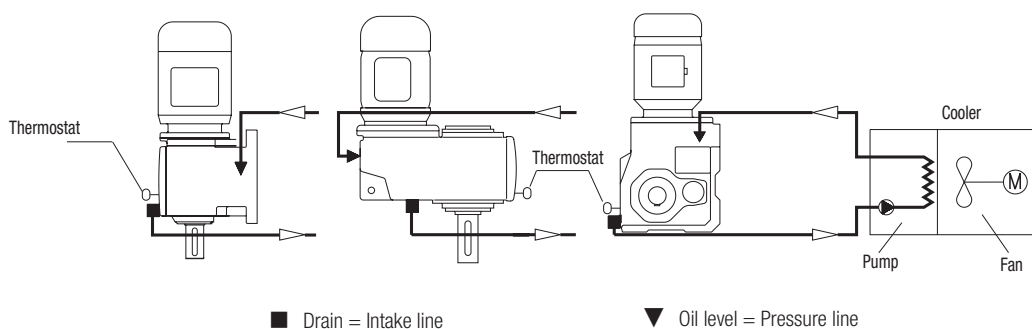
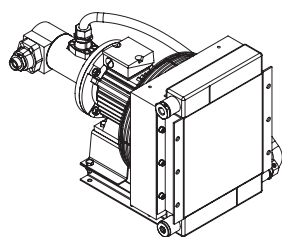

Delivery

Oil cooler, gear unit with special type plate, hose pack, PT100

Decentralised Product Group

NORD DRIVESYSTEMS understands decentralised inverters and starters to be devices which are mounted on the motor or mounted in the vicinity of the drive with the aid of wall mounting kits. This means that the devices must provide the same level of explosion protection as the drives with which they are associated. A 1:1 connection is required for this.

It is not permissible for an inverter to operate two motors simultaneously. NORD DRIVESYSTEMS is the manufacturer of all inverters and starters sold by NORD and can take all of the necessary measures from development and production up to quality control to ensure that the combination and electrics are ideally matched.

NORD has the following decentralised product groups which may all be installed in Ex Zone 22.

▶ **NORDAC Start motor starter SK 135E**

The motor starter NORDAC START is a decentralised wear-free electronic motor starter for soft starting of all kinds. It is equipped with a reversing function and internal motor protection and can therefore be flexibly integrated into any system.

▶ **NORDAC BASE – Frequency inverter SK 180E**

The NORDAC BASE is NORD's economical drive solution for the decentralised frequency inverter technology sector. With the NORDAC BASE, you purchase technology with a robust design that has been specially developed for simple drive solutions for installation outside the control cabinet at low cost.

▶ **NORDAC FLEX – Frequency inverter SK 200E**

Flexible to install, easy to service. The NORDAC FLEX is our most flexible inverter that can be tailored to any customer application by means of scalable functions. Installing and servicing the SK 200E can be carried out quickly and reliably due to its extensive plug-in capability and easy parameter transfer via EEPROM memory.

Decentralised product groups



Device	Within ATEX-Zone 22	Outside of a zone
NORDAC START	0,25 ... 7,5 kW	0,25 ... 7,5 kW
NORDAC BASE	0,25 ... 2,2 kW	0,25 ... 7,5 kW
NORDAC FLEX*	0,55 ... 7,5 kW	0,55 ... 22 kW

* The NORDAC FLEX can only be used up to 7.5 kW (400V) or up to 4 kW (230V). After that, a fan is integrated in the unit and the approval for the ATEX environment is no longer given.

Extensions for devices which are used within the ATEX zone:

- ▶ Internal CU4 modules / internal braking resistors
- ▶ ATEX Potentiometer
- ▶ Wall mounting kit without fan

Protection class	IP55	IP66
Non-conducting dust II3D Ex tc IIIB T125°C Dc X		Yes
Conducting dust II3D Ex tc IIIC T125°C Dc X	-	Yes

Sealing the devices is essential for safe and reliable operation. Special IP66 screw plugs and particularly reliable housing seals are used for this purpose. Conversions may only be made by NORD or by persons certified by NORD!

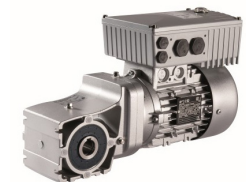

Attention



Decentralised frequency inverters for „ATEX“ dust explosion protection



To ensure smooth commissioning, documentation is available in the following languages:

Available languages

Documentation	DE	EN	FR	ES	P	RU	PL	CN	US	CZE	IT	NL
BU 0135E	X	X	X	X	X	X	X					
BU 0180 / 0185	X	X	X	X	Y	X	Y	X		Y	Y	Y
BU 0200 / 0240	X	X	X	X	Y	X	X	X	X		Y	Y

X - Main instruction

Y - Brief instruction

Usable characteristic curves

The frequency inverters can be operated with variously set characteristic curves. The settings for this are stated in B1096. The following are possible:

- ▶ 50 Hz characteristic curve (only for ASM asynchronous motors)
- ▶ 60 Hz characteristic curve (only for ASM asynchronous motors)
- ▶ 87 Hz characteristic curve (only for ASM asynchronous motors)
- ▶ 100 Hz characteristic curve (for ASM)

Settings

It is essential that the following settings are complied with for operation:

- ▶ Pulse frequency 4 – 6 kHz
- ▶ Vector regulation
- ▶ Setting of the I²t trigger curve
- ▶ Maximum frequency 100 Hz
- ▶ Temperature sensor triggering must be used and tested

Options

The otherwise extensive range of options is reduced to just a few for starters and inverters which are operated in the Ex zone.

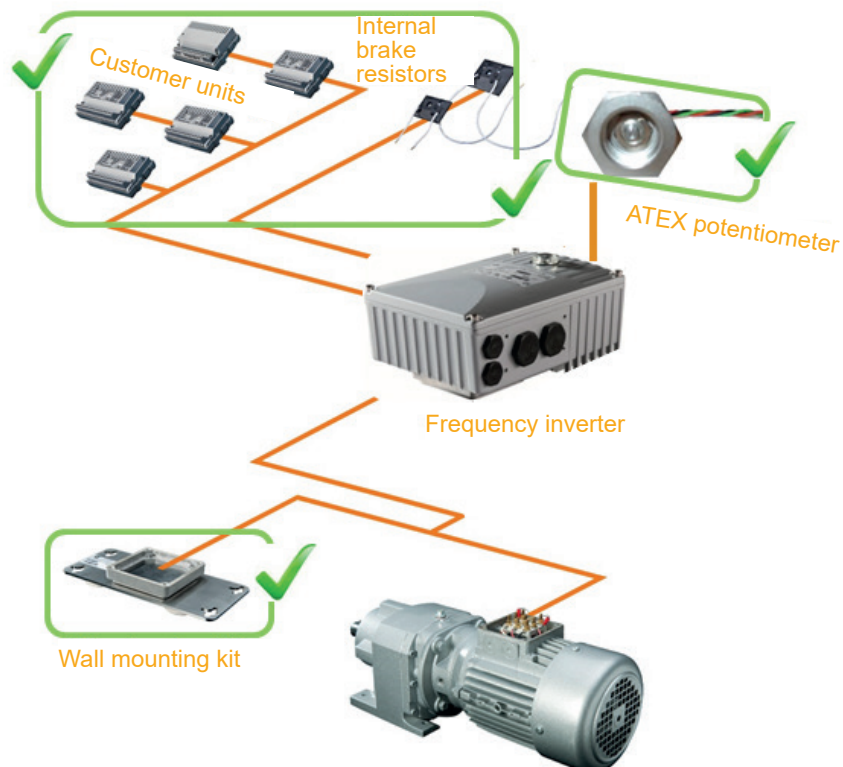

Frequency inverters and starters for installation outside of the Ex zone

For safe operation of motors within the Ex zone, motor manufacturers specify requirements for the technical design and settings of inverters and starters.

Details of these can be found in the relevant operating and maintenance instructions.

If the motors and inverters from the same manufacturer are used, it is very likely the devices will be in sync.

For explosion protection a 1:1 connection between the motor and the inverter is necessary. It is not permissible for an inverter to operate two motors simultaneously. NORD DRIVESYSTEMS is the manufacturer of all inverters and starters which are sold by NORD and can take all of the necessary measures from development and production up to quality control to ensure that the combination and electrics are ideally matched.

▶ NORDAC LINK Motor starter SK155E

One product, many advantages. The NORDAC LINK motor starter impresses with its high plug-in capability and its easy installation. It can be freely configured and easily installed. Commissioning and servicing of the motor starter is performed easily with the integrated maintenance switch and the local manual control facility. It can also be integrated into various field bus systems. In short: The SK 155E is simply convenient.

▶ NORDDAC LINK Frequency inverter SK250E

The NORDAC LINK is the convenient NORD drive solution for flexible decentralised installation. Depending on the application and the requirements, NORDAC LINK can be freely configured, which results in a large number of different potential applications for this inverter. The high level of plug-in capability enables fast and easy installation of the units. Commissioning and servicing of the system is performed quickly with the integrated maintenance switch and the local manual control facility. The NORDAC LINK can be integrated into all common bus systems.

▶ NORDAC PRO Frequency inverter SK500E

The NORDAC PRO is the inverter for all drive applications. It offers a wide power range, and its functionality can be extended with plug-in option modules. For this inverter, variable cooling concepts are used to remove heat, which can enable the removal of heat outside of the control cabinet and can be simply adapted to the requirements of the application with various option modules.

Device	Within ATEX-Zone 22	Outside of ATEX
NORDAC LINK (Starter)	--	0,25 ... 3 kW
NORDAC LINK (Inverter)	--	0,55 ... 7,5 kW
NORDAC PRO	--	0,25 ... 160 kW

Documentation	DE	EN	FR	ES	P	RU	PL	CN	US	CZE	IT	NL
BU 0155	X	X	X			X						
BU 0250	X	X	X			X						
BU 0500 / 0540	X	X	X	X	Y	X	X	X		X	Y	Y

X - Main instruction

Y - Brief instruction

Available languages

NORD DRIVESYSTEMS provides extensive documentation. It ranges from the description of the product groups gearboxes, motors and inverters in catalogues, to the provision of drawings and data sheets, to operating and maintenance instructions.

This section is intended to provide a brief overview.

This Ex-catalogue is a supplement to motor and gear unit catalogues M7000, G1000, G2000, G1012 and G1035. These can provide important information for the selection of the gear unit as well as descriptions of the various kinds and types of gear units and their options. Possible speeds and gear ratios as well as the associated output torques are shown.

Use of Ex motors may result in slightly changed data, which can be obtained from the offer in case of an enquiry.

Motor catalogue M7000 contains information for motor selection and technical explanations.

Catalogues



Documentation

Customer portal
myNORD

Drive Expert / MYNORD

The product configurator in the myNORD customer portal (www.mynord.com) is also available as an alternative to catalogues. In this, all drive units, including Ex drive units and their options can be selected for

- ▶ Precise configuration.
- ▶ Direct generation of CAD-data (3D models, dimensioned drawings, outline drawings).
- ▶ Create offers online

It must be emphasised that the configurator indicates whether or not a selected drive unit is ATEX compliant. Price information as well as an enquiry/order form are also included.

Here are some impressions from this program:

Home | myNORD | Product selection

MYNORD PRODUCT SELECTION

Ordering process

ORDERS & QUOTES

PROJECTS

You don't have sufficient privileges to access the area "projects".

ALL PROJECTS

CONFIGURATIONS

You don't have sufficient privileges to access the area "configurations".

ORDERS

ALL ORDERS

Create new product /
CAD

CREATE NEW PRODUCT / CAD

PRODUCT / CAD CONFIGURATOR

Create a new product & CAD configuration

Your project reference (optional)

Product

CONFIGURE

Product search for Geared Motors



- Fast product selection from the entire range of geared motors
- Search for motor power, output speed or torque.
- Clear comparison of search results
- Sorting function

START SEARCH

Preview of possible partial results as a result of using this software. Please contact your NORD Sales contact partner for more detailed information.

NORDBLOC.1 Helical gear units 372.1-90LP/4 II3D



Motor power	1.5 kW	Gear ratio	9.4
Shaft dimension	25 x 50 mm	Output torque	95.2 Nm
Output speed	150 1/min	Max. radial force	on request
Operating factor	2	Max. axial force	on request

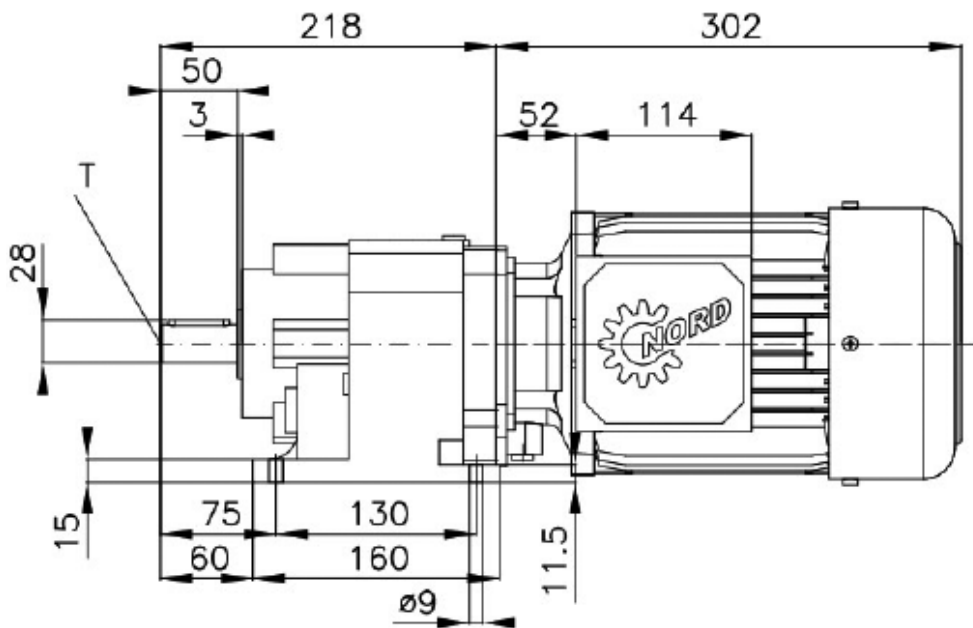

Documentation

Technical Data Sheet

NORDBLOC.1 Gearmotor SK 372.1 /3D - 90LP/4 /3D TF

HazHazardous Location	Zone 22 - Dust
ATEX Equipment Category Motor	3D - Category 3 Dust
ATEX Equipment Category Gearbox	3D - Category 3 Dust
ATEX Ambient Temperature	-20°C - +40°C
ATEX Installation Attitude	0m - 1000m
Lateral forces at the output shaft [N]	0
ATEX: force applied in the middle of the shaft	Yes
Max axial force [N]	0
ATEX Inverter operation	No
Product Name	Helical Inline Gears NORDBLOC.1
Input Speed	1414 1/min
(EP) Motor Series	00
Motor Inverter Speed Range	Standard Line Powered - Inverter Capable
Ratio	9,4
Output Speed	150 1/min
Service Factor	2
Output torque	95.2 Nm
Mounting Pos	M1
(EP) Gearbox Housing Material Type	Aluminum Housing
Type of housing	Foot Mount
Output Shaft	Solid Keyed Shaft
Output Shaft Dia	25X50 mm
Output Shaft Material	Standard
Gearbox Breather Options	Autovent
Gearbox Sealing Options	Standard
Gearbox Options	ATEX 3D/3G Gearbox
Bearing Design	Standard Bearings

NORDBLOC.1 Gearmotor SK 372.1 /3D - 90LP/4 /3D TF

Lubricant	Mineral Oil CLP 220 (Standard)
Lubricant Qty	0,45 l
Sealed Surface Conversion	No Surface Sealing Conversion
Paint Coating	NSD" (F 3.0): For indoor and protected outdoor installation
Paint Color	RAL 7031 Bluegrey
ATEX Description Motor	II 3D Ex tc IIIB T125°C DcX
Power	1,5 kW
Voltage	230/400 V
Frequency	50 Hz
Current 1	5.61 A
Current 2	3.24 A
Cosinus	0.81
Motor Duty	S1 - Continuous
Enclosure	IP55
Insulation	F
Motor Cooling	TEFC - Totally Enclosed Fan Cooled
Terminal Box Pos	1
Conduit Entry Loc	1
Motor Option	ATEX 3D Motor
	Thermistor

Documentation

Documentation accompanying the order

All deliveries of Ex drives to destination countries in the EU contain complete printed documentation in German, as well as in a language which can easily be understood by the operator.

Customers are requested to state the required language in their request for an offer.

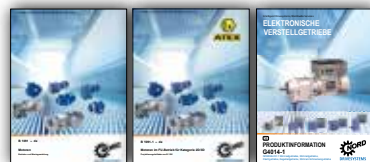

- ▶ For Ex gear units, **B2000** is supplied, which specifically deals with explosion protection,
- ▶ **B1091** is intended for main operating motors,
- ▶ For use of motor mounted inverters for **Zone 22** documents **B1091**, **B1091-1** and **G4014-1** are supplied
- ▶ bei Verwendung von motoraufgebauten Umrichtern für die **Zone 22** werden die Dokumente **B1091**, **B1091-1** sowie **G4014-1** mitgeliefert.

NORD Homepage

All operating and maintenance instructions, spare parts lists and certificates can be found under www.nord.com.



The screenshot shows the NORD website navigation bar with the logo and 'DRIVESYSTEMS' text. The main menu includes 'Products', 'myNORD', 'Documentation', 'Industries', and 'NORD'. The 'Documentation' page is active, featuring the heading 'Documentation' and the text: 'To ensure that we always understand you, we communicate with our customers in 20 different languages.' Below this text are three image-based links: 'Manuals' (showing a stack of manuals), 'Catalogues' (showing a G1050 catalogue), and 'Flyers/Brochures' (showing a company brochure).

Rapid access enables a targeted search for documents:

Home | Documentation | Certificates

Certificates

Direct Access

Selection Results. 5 found in English, 54 found in other languages

TITLE	LANGUAGE(S)	VERSION	TYPE	DOWNLOAD
Declaration of conformity - ATEX 2D NORD Motors - frame size: 63 - 200 (C422110)	English Other languages	2018	ATEX	PDF (107 KB)
Declaration of conformity - ATEX 3D NORD Motors - frame size: 63 - 250 (C422111)	English Other languages	2019	ATEX	PDF (62 KB)
EG-Type Test Certificate - ATEX 2D NORD Motors (C422120_2004)	English Other languages		ATEX	PDF (637 KB)
EG-Type Test Certificate - ATEX 2D NORD Motors, 4th Supplement (C422121_2004)	English Other languages		ATEX	PDF (449 KB)
EG-Type Test Certificate - ATEX 2D NORD Motors (C422122_2013)	English Other languages		ATEX	PDF (351 KB)

If the name of the document is known, the "search" will be successful.

[Getriebebau NORD GmbH & Co. KG](#)
[Contact](#)
[myNORD Login](#)

[ENGLISH](#)

G4014-1

[Products](#) |
 [myNORD](#) |
 [Documentation](#) |
 [Industries](#) |
 [NORD Group](#)

Home | Global

Search results

Showing 1 - 10 of 2006 for "G4014-1"

NORD - Electronic Variable Speed Drives(**G4014-1**)

Manual Electronic Variable Speed Drives

>

NORD - Electronic Variable Speed Drives(**G4014-1**)

Catalogues Electronic Variable Speed Drives

>

Documentation

Accompanying information material:

- ▶ Manuals: German, English, French, Spanish ...
- ▶ Poster: Gas, dust
- ▶ Source:
 - ⇒ Sharepoint
 - ⇒ Presentation + Training
 - ⇒ Poster + Manual
 - ⇒ ATEX

Abbreviations

2D	Category 2D		
3D	Category 3D (non-conducting dust)		
ATEX	ATmosphères EXplosibles	IE1	Efficiency as per IE1
DIN	Deutsches Institut für Normung e.V. <i>[German Standards Institute]</i>	IE2	Efficiency as per IE2
EN	European standard	U/f	Voltage/frequency characteristic curve

Legend / Formula symbols

$\cos \varphi$	Power factor	M	Torque [Nm] or [%]
Tu	Ambient temperature [°C]	n	Speed [rpm]
T125 / T140	max. surface temperature [°C]	P _N	Rated power [kW]
f _s	Stator frequency [Hz]	R _{St}	Resistance on line [Ω]
f _N	Nominal frequency [Hz]	U _N	Rated voltage [V]
I _N	Nominal motor current [A]		

An overview of NORD range

G1000 Fixed speeds

UNICASE housing 50 / 60 Hz

- ▶ NORDBLOC.1® Helical geared motors
- ▶ Helical geared motors
- ▶ Parallel geared motors
- ▶ Helical-Bevel geared motors
- ▶ Helical-Worm geared motors



G4014 Electronic variable speed drives

- ▶ NORDBLOC.1® Helical geared motors
- ▶ Helical geared motors
- ▶ Parallel geared motors
- ▶ Helical-Bevel geared motors
- ▶ Helical-Worm geared motors



G1050 MAXXDRIVE® Large Industrial gear units

UNICASE housing 50 / 60 Hz

- ▶ Parallel-Axis gear units
- ▶ Right_Angle gear units



G1035 UNIVERSAL Worm gear units

- ▶ SI and SMI



F3018_E3000 Frequency inverter SK180E

F3020_E3000 Frequency inverter SK200E

F3060_E3000 NORDAC PRO

Frequency inverter SK 500P



EN

Headquarters:

Getriebebau NORD GmbH & Co. KG

Getriebebau-Nord-Str. 1

22941 Bargteheide, Deutschland

T: +49 45 32 / 289 - 0

F: +49 45 32 / 289 - 22 53

info@nord.com