



Frequency inverter for control cabinet application

NORDAC *PRO* SK 500P series



Top class inverter technology

NORDAC *PRO*, SK 500P series



[NORDAC *PRO* - SK 500P](#)

NORDAC *PRO* SK 500P frequency inverters are available for motors with rated powers from 0.25 to 22.0 kW (up to 160 kW, in preparation)(15/18.5/22 kW [available for SK 530P and higher](#)). With their very compact design, the so-called book size format, they are perfect for space-saving installation in control cabinets.

Notable features across the entire product line include:

- ▶ Sensorless current vector control which ensures constant speeds in case of fluctuating loads and very high torques during start-up
- ▶ 200% overload reserve which provides greater operational safety in cranes and lifting gear applications
- ▶ Operation of asynchronous and synchronous motors
- ▶ Integrated brake chopper for 4-quadrant operation
- ▶ Integrated line filter as the basis for optimal EMC performance
- ▶ Integrated PLC, which enables convenient free programming of drive-related functions according to IEC 61131-3.

These features are as much a part of the basic configuration as the separately configurable PID or the process controller.

Functional safety is increasingly becoming the focus of attention in drive technology. To meet the various safety requirements, the NORDAC *PRO* also offers functional extensions to implement single or dual channel solutions for Safe Torque Switch-off and Safe Stop.

An optional removable operating display provides an extensive selection of operational displays and status information. Naturally, it also allows direct access to parameterisation.

As standard, the frequency inverters are equipped with an integrated mains unit to supply the control board. The [USB port](#), which is provided as standard for configuration version SK 530P and higher, also provides the facility of accessing the frequency inverter control board without connection of the mains voltage.

Devices with configuration level SK 530P and higher are equipped with a separate 24 V DC connection. These devices can also be parameterised when the power is switched off. Restricted diagnosis and communication with the bus is also retained.

Optional SK CU5 extensions, which can be combined with all SK 530P or SK 550P devices, complete the range of functions.

These include the encoder extension or the universal encoder interface for connection of a wide range of encoders (e.g. SSI, EnDat 2.1), which in combination with the installed POSICON are the ideal solution for all types of positioning (relative and absolute). Only one SK CU5 extension can be connected between the frequency inverter and the operating display.

An Ethernet interface is integrated in configuration levels SK 550P and above. During commissioning this can be simply set by switching a parameter to the required dialect (Ethernet/IP®, EtherCAT®, PROFINET IO® or POWERLINK). The great flexibility for system planning is enhanced by the comparatively small variance in hardware

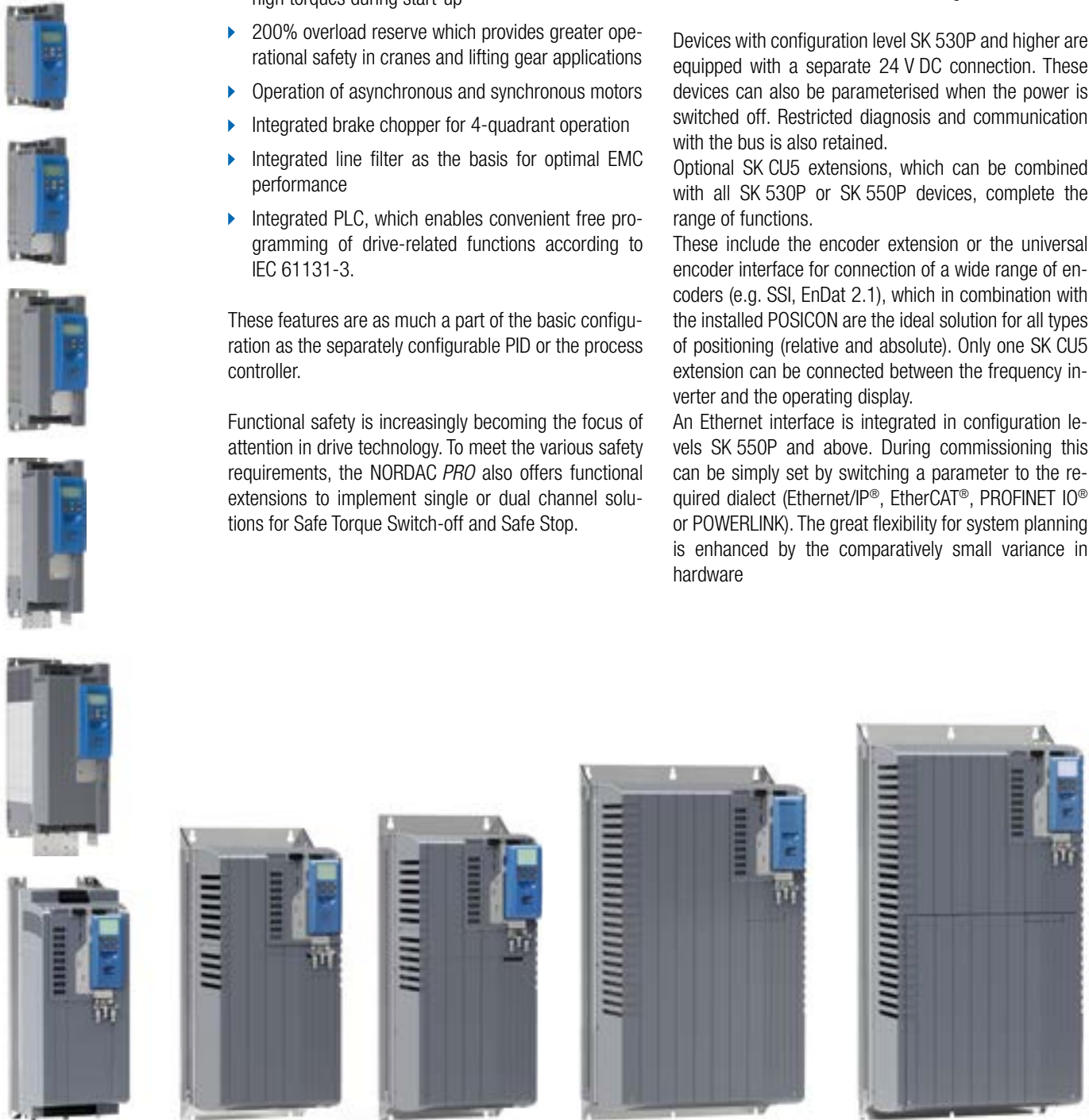

Basic configuration

- Sensorless current vector control (ISD control) for high precision control and fast response times
- Brake management, electromechanical holding brake
- Brake chopper to divert generated energy to a brake resistor
- CANopen® including drive profile DS402
- POSICON variants with positioning function (relative and absolute)
- RS-485/RS-232 diagnostic interface
- 4 switchable parameter sets for flexible use of parameter settings (e.g. switching between drive units with different motor data)
- All common drive functions such as acceleration/braking on a ramp, S curves
- Parameters pre-set with standard values, hence immediately ready for use
- Scalable display values
- Stator resistance measurement to ensure optimal control characteristics
- Integrated PLC functionality
- Plug-in connection terminals
Available for all devices up to 2.2 kW



Optional

- Interfaces for many Industrial Ethernet-based bus systems
- Removable operating display with extensive operating and status indicators. Parameter editing facility.
- Variants for implementation of safe drive functions (e.g. STO, SS1-t)
- Interface extensions for connection of encoders and IOs
- USB-C interface for parameterisation via PC using the NORDCON software, without additional connection of a mains or control voltage.



NORD provides the new SK 500P with features for easier working:

Electrical connection Power terminals

In addition to the control terminals on the front (which are always pluggable), for the two small sizes of frequency inverters with rated powers up to 2.2 kW, all other power terminals (e.g. line and motor connections, connections to multi-function relays, etc.) can be removed for maintenance. In this way, wiring of the very compact devices can be carried out easily and safely even in confined control cabinet spaces.

The architecture of Size 3 (frequency inverters with rated powers of 3.0 kW and above) allows so much space that a plug-in design of the power terminals would not provide any further advantage.



Control terminals

Pluggable control terminals are nothing special. However, the fact that the NORDAC *PRO* is equipped with an integrated „3rd hand“ which simply fixes the spring terminals for wiring will probably be gladly welcomed by most technicians.



Parameter setup

... do you want to view operating values or error messages or access and modify frequency inverter parameter settings?

Use the method that suits you:

- ▶ Direct access with the snap-on SK TU5-CTR technology unit or SK TU5-PAR (optional)
- ▶ Separate SK PAR-5H or SK CSX-3E (optional) control and parameterisation units which can be mounted in the control cabinet doors
- ▶ NORDCON software (free) – by connecting a Windows computer via USB-C ¹ or RJ12
- ▶ NORDCON APP (free) for connection to a mobile terminal device via NORDCON ACCESS BT (optional)
- ▶ Removable data carrier (microSD) for backup and transfer of parameter data sets (optional)



Available for SK 530P and higher

¹ No additional connection of a mains or control voltage required, USB-Cable “SK CE-USB-C-PC-USB-3M” required.



Standards and approvals

All devices of the entire series comply with the standards and directives listed below.

Approval	Directive	Applied standards	Certificates	Code
CE (European Union)	Low Voltage Directive 2014/35/EU	EN 61800-5-1 EN 60529	C310601	
	EMC 2014/30/EU	EN 61800-3 EN 63000		
	RoHS 2011/65/EU	EN 61800-9-1 EN 61800-9-2		
	Delegated directive (EU) 2015/863			
	Ecodesign 2009/125/EG			
	Regulation (EU) Ecodesign 2019/1781			
UL (USA)		UL 61800-5-1	E171342 ¹	
CSA (Canada)		C22.2 No.274-13	E171342 ¹	
RCM (Australia)	F2018L00028	EN 61800-3		
EAC (Eurasia)	TR CU 004/2011, TR CU 020/2011	IEC 61800-5-1 IEC 61800-3	EA3C N RU Д- DE.HB27.B02718/20	
UkrSEPRO (Ukraine)	F2018L00028	EN 61800-5-1 EN 60529 EN 61800-3 EN 63000 EN 60947-1 EN 60947-4 EN 61558-1 EN 50581	C311900	
UKCA (United Kingdom)		EN 61800-5-1 EN 60529 EN 61800-3 EN 63000 EN 61800-9-1 EN 61800-9-2	C350601	

Type code

Frequency inverters

SK 530P-370-340-A

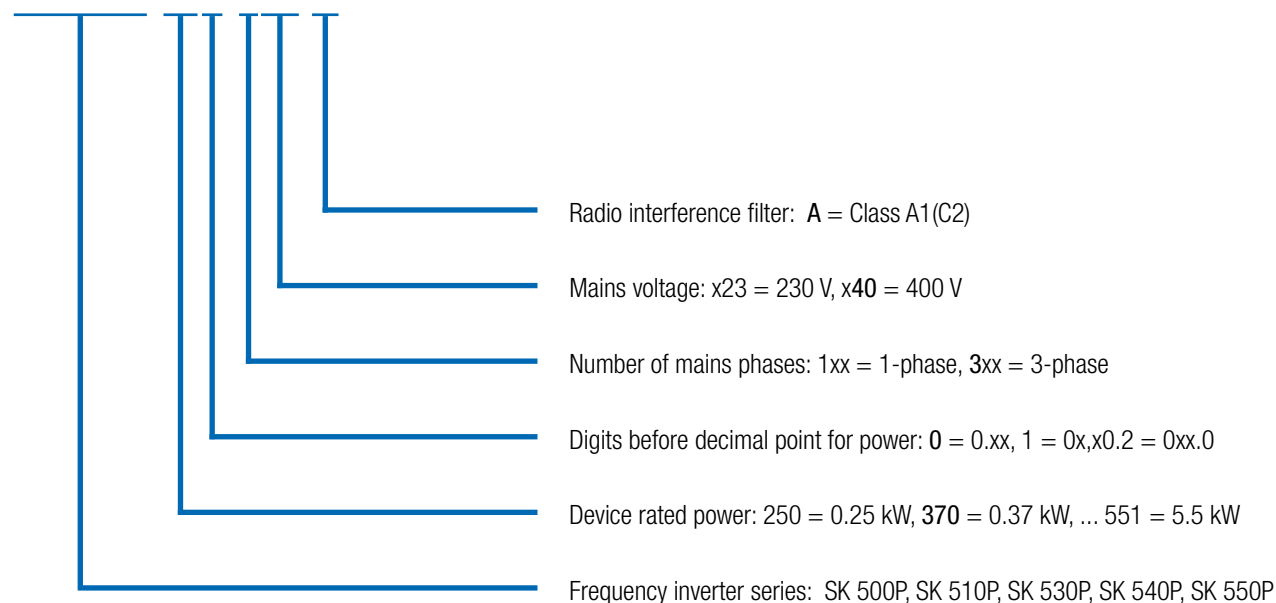

Technology units

SK TU5-CTR

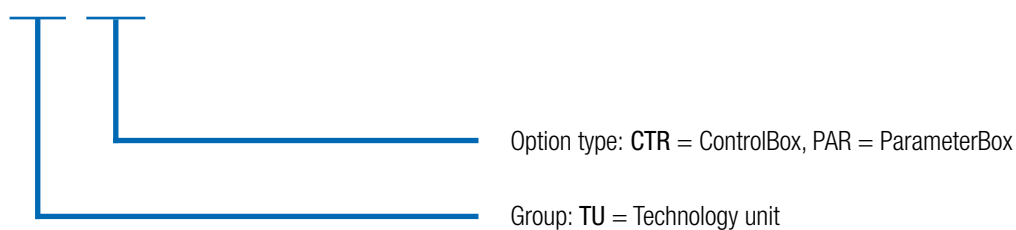

Customer units

SK CU5-STO

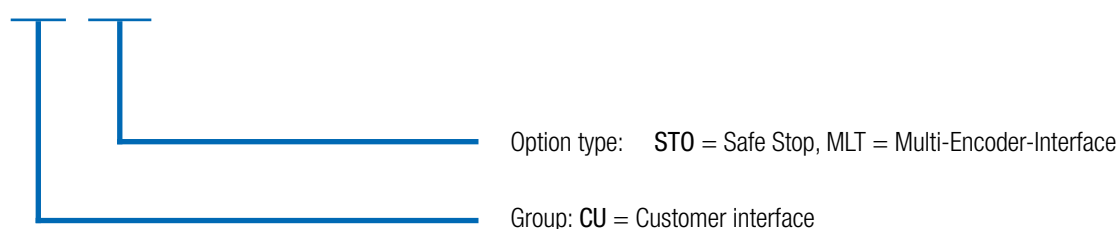

NORDAC PRO

All versions at a glance

	Basic Drive SK 500P SK 510P	Advanced Drive SK 530P SK 540P SK 550P
	Size 1-4	Size 1-5
Sensorless current vector control (ISD control)	●	●
Asynchronous motor operation (closed-loop and open-loop)	●	●
Synchronous motor operation (PMSM) (closed-loop and control without encoder)	●	●
Brake management for mechanical holding brake	●	●
Brake chopper (brake resistor optional)	●	●
RS-232 diagnostic interface	●	●
4 switchable parameter sets	●	●
All normal drive functions	●	●
Parameters pre-set with standard values	●	●
Stator resistance measurement	●	●
Energy-saving function, optimised efficiency in partial load operation	●	●
Integrated EMC line filter according to EN 61800-3, Category C2 up to 20 m motor cable, Category C1 up to 5 m motor cable (devices above 0.75 kW)	●	●
Shielding plate for connection of shielded control cables for EMC-compliant wiring.	●	●
Extensive monitoring functions	●	●
Load monitor	●	●
Link circuit coupling	●	●
Lifting gear functionality	●	●
PID controller	●	●
Process controller / compensator control	●	●
Incremental encoder input (HTL / TTL) for speed feedback - servo mode	● ¹	●
POSICON	●	●
PLC functionality	●	●
USS, Modbus RTU (RJ12)	●	●
CANopen® (connection terminals)	●	●
PROFINET IO® (default), EtherCAT®, Ethernet IP®, POWERLINK	○	● ²
"Safe Torque Switch-off" and "Safe Stop" (STO, SS1) functions	● ³	● ⁴
USB port (Parameterisation of the FI by means of NORDCON without mains or control voltage connection)	○	●
Internal 24 V power supply unit to supply the control board	●	●
External 24 V DC supply for the control board voltage supply with automatic switch-over between the internal and external 24 V DC control voltage	○	●
Universal encoder interface	○	●
MicroSD slot, port for removable data carrier	○	●
Removable data carrier (microSD) for backup and transfer of parameter data sets	○	●
Operating display, removable for display of status and operating information and for control	●	●
Communication interface, removable, for wireless communication between the frequency inverter and mobile terminal devices (tablet, smartphone)	●	●

¹ HTL only

² SK 550P only

³ SK 510P only, Single channel

⁴ SK 540P as standard, single-channel

⁵ not SK 540P

● Available as standard

● Optional

○ Not available

	Basic Drive SK 500P SK 510P	Advanced Drive SK 530P SK 540P SK 550P
	Size 1-4	Size 1-5
Control terminals	DIN	6 ¹
	DOUT	2
	Signal relay ² (... 230 V AC, 2 A)	2
	AIN ³	2
	AOUT ³	1
	Temperature sensor (PTC)	1 ⁴
Encoder interfaces	TTL RS422	●
	RS485	○
	HTL ⁴	●
	CANopen [®]	●
	SIN / COS	○
	SSI	○
	BISS-C	○
	HIPERFACE	○
	EnDat 2.1	○
	Communication	CAN / CANopen [®]
RS485 / RS232		●
Modbus RTU		●

¹ Extendable with the optional SK CU5-... customer interface

² Parameterisable with DOUT functions

³ AIN/AOUT can also be used for digital signals.

AIN: 0(2) – 10 V, 0(4) – 20 mA,

AOUT: 0 – 10 V, 0 – 20 mA

⁴ Function can only be implemented through a digital input, permissible length of encoder cables: max. 10 m

⁵ Available via optional customer unit, not SK 540P

⁶ System bus functions can only be used with restrictions.



Temperature sensor (PTC)
SK 530P and above

TTL encoder interface
SK 530P and above



Signal relay

Communication

Control terminals AIN/
AIN / DIN

zAdditional control terminals
DIN / DOUT
SK 530P and above

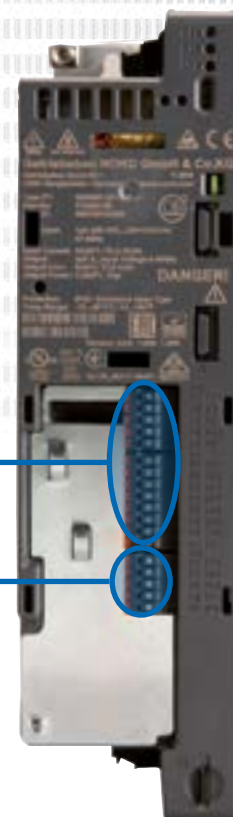

Optional modules for function extension

Frequency inverters with configuration variants SK 530P and SK 550P can be extended with a plug-in optional module. This increases the installation depth by 23 mm.

One of the following variants can be selected.

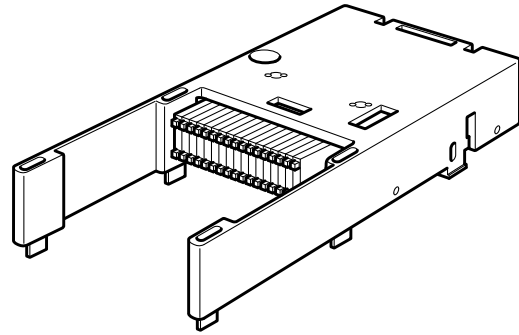

Type	Material No.	Functions	I/Os	Remarks
SK CU5-MLT	275 298 200	Encoder interface: TTL, SIN/COS, HIPERFACE, EnDat 2.1, BiSS-C, SSI Functional safety: STO - PLe / SIL 3 SS1-t - PLd / SIL 2	4 IO (usable as DIN or DOUT) 1 Safe DIN	Functional safety: 2-channel connection
SK CU5-STO	275 298 000	Functional safety: STO - PLe / SIL 3 SS1-t - PLd / SIL 2	1 Safe DIN	Functional safety: 2-channel connection



NORDAC *PRO* SK 500P frequency inverter

1 ~ 200 ... 240 V,

Output frequency	0.0 ... 400.0 Hz	Protection class	IP20
Pulse frequency	3.0 ... 16.0 kHz	Regulation and control	Sensorless current vector control (ISD), linear V/f characteristic curve
Typical overload capacity	150 % for 60 s, 200 % for 3.5 s	Motor temperature monitoring	I ² t Motor PTC / bi-metal switch
Energy efficiency class	IE2	Leakage current	<30 mA, may be considerably less depending on the size and configuration of the frequency inverter (refer to the manual for details)
Efficiency	Size 1-3 approx. 95 % Size 4-6 approx. 97% Size 7-10 approx. 98 %		
Ambient temperature	-10 °C ... +40 °C (S1) -10 °C ... +50 °C (S3, 70 % ED)		

Frequency inverters SK 5xxP ...	Nominal motor power		Nominal output current rms [A]	Mains voltage	Output voltage
	230 V [kW]	240 V [hp]			
-250-123-A	0.25	1/3	1.7	1 ~ 200 ... 240 V, +/- 10 %, 47 ... 63 Hz	3~ 0 up to mains voltage
-370-123-A	0.37	1/2	2.4		
-550-123-A	0.55	3/4	3.2		
-750-123-A	0.75	1	4.2		
-111-123-A	1.1	1 1/2	5.7		
-151-123-A	1.5	2	7.3		
-221-123-A	2.2	3	9.6		

Size 1 and 2

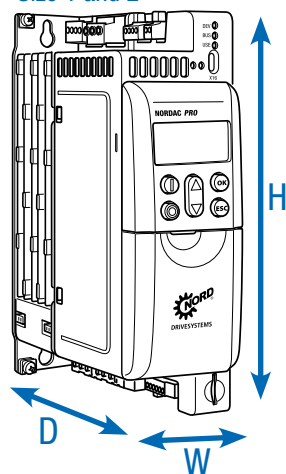

Size 3 -11

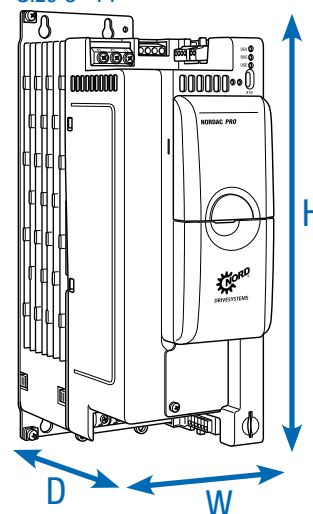

Frequency inverters SK 5xxP ...	Weight [kg]	(Overall) dimensions H x W x D [mm]	Size
-250-123-A	1.2	200 x 66 x 141	1
-370-123-A	1.2	200 x 66 x 141	1
-550-123-A	1.2	200 x 66 x 141	1
-750-123-A	1.2	200 x 66 x 141	1
-111-123-A	1.6	240 ¹ x 66 x 141	2
-151-123-A	1.6	240 ¹ x 66 x 141	2
-221-123-A	1.6	240 ¹ x 66 x 141	2

¹ SK 5xxP-221-123: Connection terminal protrudes beyond the stated overall dimension H about 15 mm.

NORDAC *PRO* SK 500P frequency inverter

3~ 380 ... 480 V

Output frequency	0.0 ... 400.0 Hz	Protection class	IP20
Pulse frequency	3.0 ... 16.0 kHz	Regulation and control	Sensorless current vector control (ISD), linear V/f characteristic curve
Typical overload capacity	150 % for 60 s, 200 % for 3.5 s	Motor temperature monitoring	I ² t Motor PTC / bi-metal switch
Energy efficiency class	IE2	Leakage current	<30 mA, may be considerably less depending on the size and configuration of the frequency inverter (refer to the manual for details)
Efficiency	Size 1-3 approx. 95 % Size 4-6 approx. 97% Size 7-10 approx. 98 %		
Ambient temperature	-10 °C ... +40 °C (S1) -10 °C ... +50 °C (S3, 70 % ED)		

Frequency inverters SK 5xxP ...	Nominal motor power		Nominal output current rms [A]	Mains voltage	Output voltage
	400 V [kW]	480 V [hp]			
-250-340-A	0.25	1/3	1.0	3~ 380 ... 480 V, -20 % / +10 %, 47 ... 63 Hz	3~ 0 up to mains voltage
-370-340-A	0.37	1/2	1.3		
-550-340-A	0.55	3/4	1.8		
-750-340-A	0.75	1	2.4		
-111-340-A	1.1	1 1/2	3.1		
-151-340-A	1.5	2	4.0		
-221-340-A	2.2	3	5.6		
-301-340-A	3.0	4	7.5		
-401-340-A	4.0	5	9.5		
-551-340-A	5.5	7 1/2	12.5		
-751-340-A	7.5	10	16.0		
-112-340-A	11.0	15	24.0		
-152-340-A	15.0	20	31.0		
-182-340-A	18.5	25	38.0		
-222-340-A	22.0	30	46.0		
-302-340-A	30.0	40	60.0		
-372-340-A	37.0	50	75.0		
-452-340-A ¹	45.0	60	90.0		
-552-340-A ¹	55.0	75	110.0		
-752-340-A ¹	75.0	100	150.0		
-902-340-A ¹	90.0	125	180.0		
-113-340-A ¹	110	150	220.0		
-133-340-A ¹	132	180	260.0		
-163-340-A ¹	160	220	320.0		

¹ Power range extension up to 160 kW in the third quarter of 2025 in preparation

Size 1 and 2

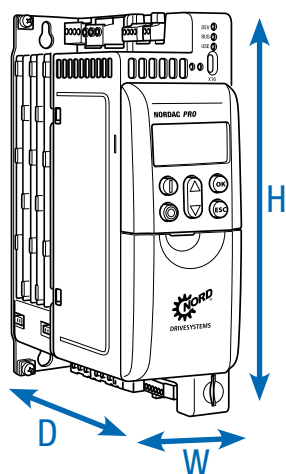

Size 3 -11

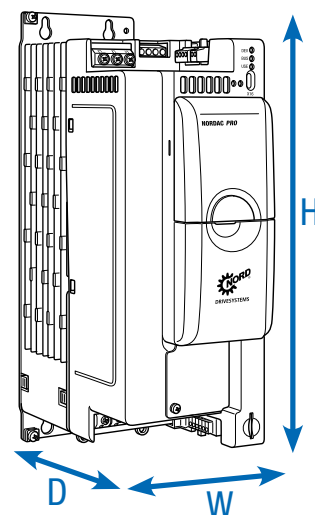





Frequency inverters SK 5xxP ...	Weight [kg]	(Overall) dimensions H x W x D [mm]	Size
-250-340-A	1.2	200 x 66 x 141	1
-370-340-A	1.2	200 x 66 x 141	1
-550-340-A	1.2	200 x 66 x 141	1
-750-340-A	1.2	200 x 66 x 141	1
-111-340-A	1.6	240 x 66 x 141	2
-151-340-A	1.6	240 x 66 x 141	2
-221-340-A	1.6	240 x 66 x 141	2
-301-340-A	2.6	286 x 91 x 175	3
-401-340-A	2.6	286 x 91 x 175	3
-551-340-A	2.6	286 x 91 x 175	3
-751-340-A	3.8	331 x 91 x 175	4
-112-340-A	3.8	331 x 91 x 175	4
-152-340-A	7.1	371 x 126 x 232	5
-182-340-A	7.1	371 x 126 x 232	5
-222-340-A	7.1	371 x 126 x 232	5
-302-340-A	15.0	495 x 185 x 246	6
-372-340-A	15.0	495 x 185 x 246	6
-452-340-A ¹	20.0	598 x 265 x 286	7
-552-340-A ¹	20.0	598 x 265 x 286	7
-752-340-A ¹	25.0	636 x 265 x 286	8
-902-340-A ¹	25.0	636 x 265 x 286	8
-113-340-A ¹	46.0	720 x 395 x 292	9
-133-340-A ¹	49.0	720 x 395 x 292	9
-163-340-A ¹	52.0	799 x 395 x 292	10



¹ Power range extension up to 160 kW in the third quarter of 2025 in preparation

Interfaces for operation, parameterisation and communication

Operation and parameterisation

Optional modules with up to 14 languages for displaying status and operational indicators, parameterisation and operation of the frequency inverter. In addition to variants for direct mounting on the device or installation in a control cabinet door, handheld versions are also available. See also Accessories starting on page 165

	Type Designation Material No.	Description	Remarks
	ControlBox SK TU5-CTR 275 297 000	Suitable for operation and parameterisation, LCD screen (illuminated), 5-digit, 7-segment display, display of measurement unit, various status and operating displays, display of utilisation level, convenient keypad.	Installation in the SK TU5 slot on the device.
	ParameterBox SK TU5-PAR 275297100	Suitable for control and parameterisation, LCD screen (illuminated), plain text display in 14 languages, memory for 5 device data sets, convenient control keypad	Installation in the SK TU5 slot on the device. Required firmware version of the frequency inverter: V1.4 R0 and higher
	ParameterBox SK PAR-5H 275 281 614	Control and parameterisation, LCD (illuminated), plain text display in 14 languages, direct control of up to five devices, memory for five device data sets, convenient control keypad, communication via RS485, including 1.5 m connection cable. Handheld, suitable for installation in a control cabinet door. IP54	Connection for data exchange with NORDCON <i>STUDIO</i> to a PC (USB 2.0), (standard "USB-C" connection cable required, e.g. material number: 275 292 100) Power supply, e.g. directly via frequency inverter or PC
	SimpleControlBox SK CSX-3E 275 281 413	Suitable for control and parameterisation, 4-digit, 7-segment display, direct control of a device, convenient control keypad, for installation in control cabinet doors.	Electrical data: 4.5 ... 30 V DC / 1.3 W, Supply e. g. directly via the frequency inverter. Control cabinet installation

Type Designation Material No.	Description	Remarks
	Control and parameterisation software NORDCON	Software for control and parameterisation as well as support for commissioning and fault analysis of NORD electronic drive technology. Parameter names in 14 languages
Free download: www.nord.com		
	Bluetooth stick NORDAC ACCESS BT SK TIE5-BT-STICK 275 900 120	Interface for wireless connection to a mobile terminal device (e.g. tablet or smartphone) via Bluetooth. With the aid of the <i>NORDCON APP</i> , the NORDCON software for mobile terminal devices, enables smart operation and parameterisation as well as commissioning assistance and fault analysis of NORD electronic drive technology.
		Available free of charge for Android and iOS
		

Line filter

Improvement of EMC

General

Line filters are used to reduce the emission of electromagnetic interference. SK 500P frequency inverters are equipped with an integrated class C2 line filter, class C3 line filter for 30 kW and higher, (max. 20 m of shielded motor cable). For devices with nominal powers from 750 W to 5.5 kW, class C1 (max. 5 m of shielded motor cable) is achieved. Various adaptive line filters are available for longer cable lengths or to improve interference suppression.

Chassis line filter, SK HLD

The line filter meets protection class IP20 and enables interference suppression Class C1 with max. 25 m shielded motor cable and Class C2 with max. 50 m cable.

The line filters are installed separately from the frequency inverter.

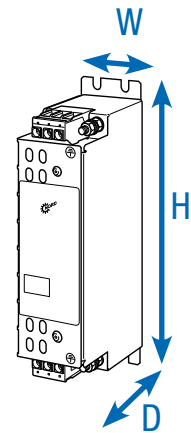

	Frequency inverters SK 5xxP ...	Line filter type Material No.	Continuous current [A]	Leakage current ¹ [mA]	(Overall) dimensions H x W x D [mm]
3~ 400 V	0.55 ... 2.2 kW	SK HLD 110-500/8 278 272 008	8.0	20 / 190	190 x 45 x 75
	3.0 ... 5.5 kW	SK HLD 110-500/16 278 272 016	16.0	21 / 205	250 x 45 x 75
	7.5 kW	SK HLD 110-500/30 278 272 030	30.0	29 / 280	270 x 55 x 95
	11.0 kW	SK HLD 110-500/42 278 272 042	42.0	30 / 290	310 x 55 x 95
	15.0 ... 18.5 kW	SK HLD 110-500/55 278 272 055	55.0	30 / 290	255 x 85 x 95
	22.0 kW	SK HLD 110-500/75 278 272 075	75.0	22 / 210	310 x 85 x 135

¹ Leakage current 1st value: rated for the maximum permissible input voltage fluctuation according to IEC 38 + 10%

Leakage current 2nd value: calculated at maximum input voltage and failure of 2 phases (typically at 50 Hz)

Mains chokes

Reduction of mains feedback

General

It may be necessary for some drive systems to use mains chokes to reduce dangerous mains current peaks. With their use, external mains feedback effects are considerably reduced and the proportion of current harmonics is reduced to a minimum. The input current is reduced to approximately the value of the output current.

It is recommended that a mains choke be used at all times for a frequency inverter capacity of 45 kW and above. This will have an additional positive effect on device protection and EMC characteristics. All chokes have protection class IP00 and are UL-recognised.

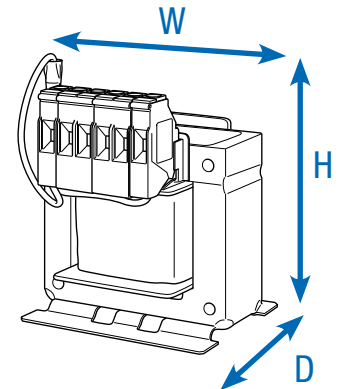

	Frequency inverters SK 5xxP ...	Choke type Material No.	Continuous current [A]	Inductance [mH]	(Overall) dimensions H x W x D [mm]
1~230 V	0.25 ... 0.37 kW	SK CI5-230/006-C 276 993 005	6.0	4.88	70 x 66 x 60
	0.55 ... 0.75 kW	SK CI5-230/010-C 276 993 009	10.0	2.93	95 x 78 x 84
	1.1 ... 2.2 kW	SK CI5-230/025-C 276 993 024	25.0	1.17	98 x 87 x 84
3~400 V	0.25 ... 0.75 kW	SK CI5-500/004-C 276 993 004	4.0	3 x 7.35	117 x 80 x 60
	1.1 ... 2.2 kW	SK CI5-500/008-C 276 993 008	8.0	3 x 3.68	140 x 120 x 85
	3.0 ... 5.5 kW	SK CI5-500/016-C 276 993 016	16.0	3 x 1.84	140 x 120 x 95
	7.5 ... 11.0 kW	SK CI5-500/035-C 276 993 035	35.0	3 x 0.84	167 x 155 x 110
	15.0 ... 22.0 kW	SK CI5-500/063-C 276 993 063	63.0	3 x 0.47	206 x 185 x 122
	30.0 ... 37.0 kW	SK CI5-500/100-C 276 993 101	100.0	3 x 0.30	205 x 267 x 155
	45.0 kW	SK CI1-480/100-C 276 993 100	100.0	3 x 0.29	263 x 240 x 148
	55.0 ... 75.0 kW	SK CI1-480/160-C 276 993 160	160.0	3 x 0.18	268 x 352 x 140
	90.0 kW	SK CI1-480/280-C 276 993 280	280.0	3 x 0.10	268 x 352 x 169
	110.0 ... 132.0 kW	SK CI1-480/350-C 276 993 350	350.0	3 x 0.08	268 x 352 x 169
	160 kW	nicht verfügbar			

Link circuit choke

Reduction of mains feedback

Link circuit choke SK DCL

Similar to a mains choke, reduces the network loads of a frequency inverter that are inherent to its functional principle. It is connected to easily accessible contacts in the frequency inverter's intermediate circuit and is available for 45 kW and above. All chokes have protection class IP00 and are UL-recognised.

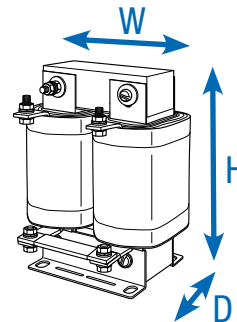

Frequency inverter SK 5xxP ...	Choke type Material No.	Continuous current [A]	Inductance [mH]	(Overall) dimensions H x W x D [mm]
45.0 ... 55.0 kW	SK DCL-950/120-C 276 997 120	120.0	0.50	230 x 148 x 147
75.0 ... 90.0 kW	SK DCL-950/200-C 276 997 200	200.0	0.30	260 x 170 x 153
110 kW	SK DCL-950/260-C 276 997 260	260.0	0.25	284 x 180 x 174
132 kW	SK DCL-950/320-C 276 997 320	320.0	0.20	282 x 180 x 189
160 kW	SK DCL-950/380-C 276 997 380	200.0	0.17	282 x 180 x 189

Motor chokes

Compensation of cable capacitances

General

Long motor cable lengths (cable capacity) often require the use of additional motor chokes on the frequency inverter output. In addition, the use of motor chokes has a positive effect on device protection and EMC characteristics.

The specified motor chokes are rated for a pulse frequency of 3 to 6 kHz and an output frequency of 0 to 120 Hz. All chokes have protection class IP20 and are UL-recognised.

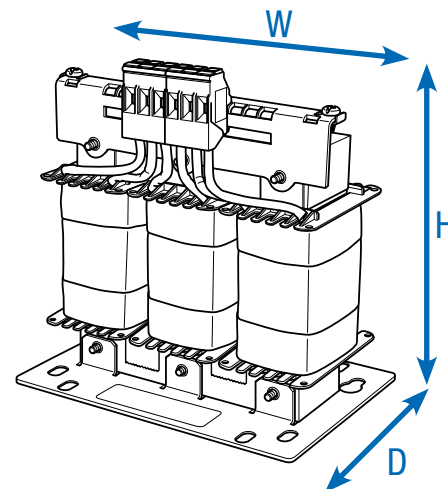

	Frequency inverters SK 5xxP ...	Choke type Material No.	Continuous current [A]	Inductance [mH]	(Overall) dimensions H x W x D [mm]
1~230 V	0.25 ... 0.37 kW	SK C05-500/002-C 276 992 002	2.5	3 x 3.68	140 x 120 x 85
	0.55 ... 0.75 kW	SK C05-500/006-C 276 992 006	6.0	3 x 1.54	140 x 120 x 95
	1.1 ... 2.2 kW	SK C05-500/012-C 276 992 012	12.5	3 x 0.74	165 x 155 x 95
3~400 V	0.25 ... 0.75 kW	SK C05-500/002-C 276 992 002	2.5	3 x 3.68	140 x 120 x 85
	1.1 ... 2.2 kW	SK C05-500/006-C 276 992 006	6.0	3 x 1.54	140 x 120 x 95
	3.0 ... 5.5 kW	SK C05-500/012-C 276 992 012	12.5	3 x 0.74	165 x 155 x 95
	7.5 ... 11 kW	SK C05-500/024-C 276 992 024	24.0	3 x 0.38	192 x 185 x 112
	15.0 ... 22.0 kW	SK C05-500/046-C 276 992 046	46.0	3 x 0.20	239 x 210 x 125
	30.0 ... 37.0 kW	SK C05-500/75-C 276 992 075	75.0	3 x 0.122	260 x 230 x 149
	45.0 kW	SK C01-460/90-C 276 996 090	90.0	3 x 0.22	352 x 144 x 325
	55.0 ... 75.0 kW	SK C01-460/170-C 276 996 170	170.0	3 x 0.13	320 x 412 x 200
	90.0 ... 110 kW	SK C01-460/240-C 276 996 240	240.0	3 x 0.07	320 x 412 x 225
	132.0 ... 160 kW	SK C01-460/330-C 276 996 330	330.0	3 x 0.03	268 x 352 x 188

Braking resistors for dynamic drive characteristics

Bottom-mounted braking resistors SK BRU5

These are available four sizes. The brake resistor can be mounted flat underneath the frequency inverter. Although this increases the installation length and depth by a few centimetres, the basic installation surface in the control cabinet is considerably reduced. The specified resistance values are electrically matched to standard applications. Brake resistors have protection class IP65 and are UL-recognised.

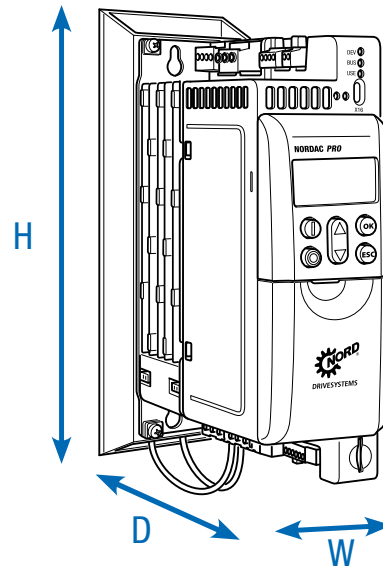

Frequency inverters SK 5xxP ...	Resistor type Material No.	Resistance [Ω]	Continuous output [W]	Short-term power [kW] ¹	(Overall) dimensions L x W x D [mm]
3~230 V	0.25 ... 0.75 kW SK BRU5-1-240-050 275 299 004	240	50	0.75	240 x 66 x 176
	1.1 ... 2.2 kW SK BRU5-2-075-200 275 299 210	75	200	3.0	280 x 66 x 176
3~400 V	0.25 ... 0.75 kW SK BRU5-1-400-100 275 299 101	400	100	1.5	240 x 66 x 176
	1.1 ... 2.2 kW SK BRU5-2-220-200 275 299 205	220	200	3.0	280 x 66 x 176
	3.0 ... 5.5 kW SK BRU5-3-100-300 275 299 309	100	300	4.5	340 x 91 x 210
	7.5 ... 11.0 kW SK BRU5-4-044-400 275 299 512	44	400	7.5	385 x 91 x 210
Temperature monitoring for SK BR5 resistors with installation close to the inverter 275 991 100			Bimetallic switch as opener Nominal switching temperature: 180°C		Broad brake resistor + 10 mm (on one side)
Temperature monitoring for SK BR5 resistors with direct installation under the frequency inverter 275 991 200			Bimetallic switch as opener Nominal switching temperature: 100°C		The dimensions apply to the frequency inverter, including the braking resistor

¹ Once within 120 s,
for a maximum duration of 1.2 s

Chassis braking resistors, SK BR2

The resistor elements are integrated into a housing cage and must be connected to the particular frequency inverter via a separate connecting cable.

The brake resistors must be mounted horizontally (apart from SK BR2-xxx/400-C).

A shielded cable which is as short as possible should be used for this purpose.

The brake resistors have protection class IP20 and are UL-recognised.

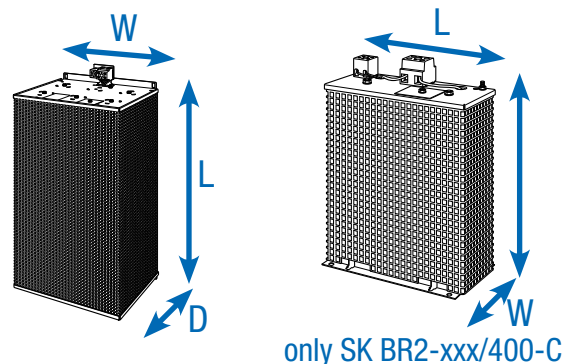

Frequency inverters SK 5xxP ...	Resistor type Material No.	Resistance [Ω]	Continuous output [W]	Short-term power [kW] ¹	(Overall) dimensions L x W x D [mm]
3.0 ... 4.0 kW	SK BR2-100/400-C ¹ 278 282 040	100	400	12.0	178 x 100 x 252
5.5 ... 7.5 kW	SK BR2-60/600-C 278 282 060	60	600	18.0	385 x 92 x 120
11.0 ... 15.0 kW	SK BR2-30/1500-C 278 282 150	30	1500	45.0	585 x 185 x 120
18.5 ... 22.0 kW	SK BR2-22/2200-C 278 282 220	22	2200	66.0	485 x 275 x 120
30.0 ... 37.0 kW	SK BR2-12/4000-C 278 282 400	12	4000	120.0	585 x 266 x 210
45.0 ... 55.0 kW	SK BR2-8/6000-C 278 282 600	8	6000	180.0	395 x 490 x 260
75.0 ... 110 kW	SK BR2-6/7500-C 278 282 750	6	7500	225.0	595 x 490 x 260
132 ... 160 kW	SK BR2-3/7500-C 278 282 753	3	7500	225.0	595 x 490 x 260
132 ... 160 kW	SK BR2-3/17000-C 278 282 754	3	17 000	510.0	795 x 490 x 260

3~ 400 V

Temperature monitoring for SK BR2 resistors integrated (2 terminals 4 mm²)

Bimetallic switch as opener.
Nominal switching temperature: 180°C.

¹ Type of assembly: vertical

² Once within 120 s,
for a maximum duration of 1.2 s

NORDAC *PRO* frequency inverters

Accessories



Signal converter +/- 10 V

For connection of a bipolar analogue signal to the unipolar analogue input of a frequency inverter, top-hat rail mounting.

Material No.: 278 910 320



Electronic brake rectifier SK EBGR-1

For direct control and supply of an electromagnetic holding brake.

Material No.: 19 140 990



IO expansion SK EBIOE-2

The generous number of standard inputs and outputs on the device can be supplemented using an extension provided for top-hat rail mounting.

Material No.: 275 900 210

Available for SK 530P and higher



NORDAC *ACCESS BT*

Bluetooth adapter SK TIE5-BT-STICK to establish wireless connection between the frequency inverter and mobile terminal devices (e.g. smartphone, tablet). Together with the free NORDCON *APP* for Android or iOS, NORD therefore provides a smart aid for control, parameterisation and troubleshooting of frequency inverters.

Material No.: 275 900 120



MicroSD card, 128 MB

Removable data carrier for archiving and transfer of parameter data sets for the frequency inverter.

Material No.: 275 292 200

Available for SK 530P and higher

EMV-Kit

For EMC-compliant connection of shielded cables and to produce strain relief.

Depending on size and configuration level, various EMC kits are optionally available.

Size of frequency inverter	Shield Motor connection ①	Shield IO ports ②	Shield Control terminals (SK CU5-...) ¹ ③
1	SK HE5-EMC-MS-HS12 275 292 300	SK HE5-EMC-IS-HS1 275 292 304	SK HE5-EMC-CS-HS1 275 292 310
2	SK HE5-EMC-MS-HS12 275 292 300	SK HE5-EMC-IS-HS2 275 292 305	SK HE5-EMC-CS-HS23 275 292 311
3	SK HE5-EMC-MS-HS34 ² 275 292 301	SK HE5-EMC-IS-HS34 275 292 306	SK HE5-EMC-CS-HS23 275 292 311
4	SK HE5-EMC-MS-HS34 ² 275 292 301	SK HE5-EMC-IS-HS34 275 292 306	
5	SK HE5-EMC-MS-HS5 ² 275 292 302	SK HE5-EMC-IS-HS5 275 292 308	
6	SK HE5-EMC-MS-HS6 ² 275 292 303		
7 and 8	SK EMC 2-6 275 999 061		
9 and 10	SK EMC 2-7 275 999 071		

¹ Available for SK 530P and higher only in combination with (1) "motor connection shield"

² Two-part



CANopen® connection

The CANopen® interface is equipped with a 4-pole screw terminal as standard.

The following alternatives are optionally available.





Designation	Material No.	Description
SK TIE5-CAO-WIRE-2X4P	275 292 201	CANopen® double terminal (screw terminal, 2x4-pole)
SK TIE5-CAO-2X-RJ45	275 292 202	CANopen® RJ45 adapter







Optional:
RJ45 adapter for
CANopen

Operation and parameterisation

Control and parameterisation units /software

Designation Material No.	Description	Remarks
 <p>ParameterBox SK PAR-5H 275281614</p>	Control and parameterisation, LCD (illuminated), plain text display in 14 languages, direct control of up to five devices, memory for five device data sets, convenient control keypad, communication via RS485, including 1.5 m connection cable. Handheld, suitable for installation in a control cabinet door. IP54	Connection for data exchange with NORDCON STUDIO to a PC (USB 2.0), (standard "USB-C" connection cable required, e.g. material number: 275292100) Power supply, e.g. directly via frequency inverter or PC
 <p>ParameterBox SK PAR-5A 275281714</p>	Suitable for control and parameterisation, LCD screen (illuminated), plain text display in 14 languages, direct control of up to 5 devices, memory for 5 device data sets, convenient control keypad, for mounting to a frequency inverter.	Power supply, e.g. directly via frequency inverter or PC Mounting to frequency inverter
 <p>SimpleControlBox SK CSX-3H 275281013</p>	Control and parameterisation, 4-digit, 7-segment display, direct control of a device, convenient control keypad, including 2 m connection cable Handheld, IP54	Electrical data: 4.5 ... 30 V DC / 1.3 W, supply e. g. directly via the frequency inverter
 <p>SimpleControlBox SK CSX-3E 275281413</p>	Suitable for control and parameterisation, 4-digit, 7-segment display, direct control of a device, convenient control keypad, for installation in control cabinet doors.	Electrical data: 4.5 ... 30 V DC / 1.3 W, supply e. g. directly via the frequency inverter. Control cabinet installation

Designation Material No.	Description	Remarks
 <p>NORDAC CONTROL I/O SK TIE5-CIO 278910150</p>	Suitable for testing analogue and digital I/Os. Handheld, IP20	
<p>Control box SK POT1-1 278910120</p> 	Potentiometer 0 ... 100% (0 ... 10 V), switch Left/AUS/Right, including 3 m connection cable. Handheld, wall mounting, IP66	
<p>Control box SK POT1-2 278910140</p> 	Suitable for control, potentiometer 0 ... 100 % (0 ... 10 V), switch Left/AUS/Right, including 20 m connection cable. Handheld, wall mounting, IP66	
<p>SimpleSetpointBox SK SSSX-3A 275281513</p> 	Suitable for control and parameterisation, 4-digit, 7-segment display, direct control of a device, 3 operating modes, convenient control keypad. Handheld, wall mounting, IP54	Electrical data: 19.2 ... 28.8 V DC, 35 mA, supply e.g. directly via the frequency inverter, communication via RS -485 or IO link

Designation
Material No.

Description

Remarks

Adapter cable
RJ12-SUB-D9
278.910.240

To connect the frequency inverter to the serial interface of a PC via SUB-D9

Length: approx. 3 m



Connection set
SK TIE4-RS232-USB
275.274.604

To connect the frequency inverter to the serial interface of a PC via USB 2.0

Consisting of adapter cable RJ12-SUB-D9 and RS-232 to USB inverter
Length: approx. 3 m + 0.5 m



Adapter cable
SK CE-USB-C-
PC-USB-3M
275.292.100

To connect the frequency inverter to a PC via USB

Length: approx. 3 m



Control and
parameterisation
software NORDCON

Software for control and parameterisation as well as commissioning assistance and fault analysis of NORD electronic drive technology.
Parameter names in 14 languages

Free download:
www.nord.com



NORDAC
ACCESS BT
Bluetooth-Stick
SK TIE5-BT-STICK
275.900.120

Interface for wireless connection to a mobile terminal device (e.g. tablet or smartphone) via Bluetooth.
With the aid of the NORDCON /APP, the NORDCON software for mobile terminal devices, enables smart operation and parameterisation as well as commissioning assistance and fault analysis of NORD electronic drive technology.

NORDCON APP available free of charge for Android and iOS



Headquarters:

Getriebebau NORD GmbH & Co. KG

Getriebebau-Nord-Str. 1

22941 Bargteheide, Deutschland

T: +49 (0) 45 32 / 289 - 0

F: +49 (0) 45 32 / 289 - 22 53

info@nord.com