

Drive Solutions for the Packaging Industry

Complete drive systems from a single source



DRIVESYSTEMS

Our Solution. Your Success.

Complete Drive Solutions from a Single Source



NORD Delivers

NORD offers first-class customer service and support along with full-featured drive solutions that can tackle the toughest requirements. All components are carefully selected and precisely configured to meet your exact specifications. In the rare case that standard components won't meet your needs, our in-house engineering team will work with you to design custom components or a complete customized system.

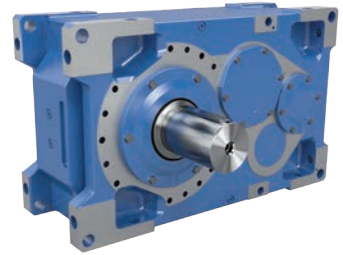

Reduce Lead Times and Decrease Inventory

- ▶ Fastest lead times in the industry with NO expedite fees
- ▶ Over 20,000,000 standard configurations to reduce or eliminate the need for custom components
- ▶ Modular drives, motors, and electronic controls minimize inventory of replacement units and parts



Global Product Designs, Standards, and Support

- ▶ Innovative, industry-standard products to support a wide range of applications
- ▶ Global sales and support network
- ▶ Dedicated mechanical and electrical application engineers ready to assist you
- ▶ Online resources available to you any time
- ▶ 24/7/365 emergency breakdown service



Increase Efficiency and Reduce Operation Costs

- ▶ myNORD online tools for fast selection, configuration, ordering, and tracking of your drive units
- ▶ Drive systems that are perfectly matched to your application for optimum performance and energy efficiency
- ▶ Program personalization, such as weekly shipment schedules and custom nameplates
- ▶ Partner with a company that is easy to do business with and wants to see you succeed!



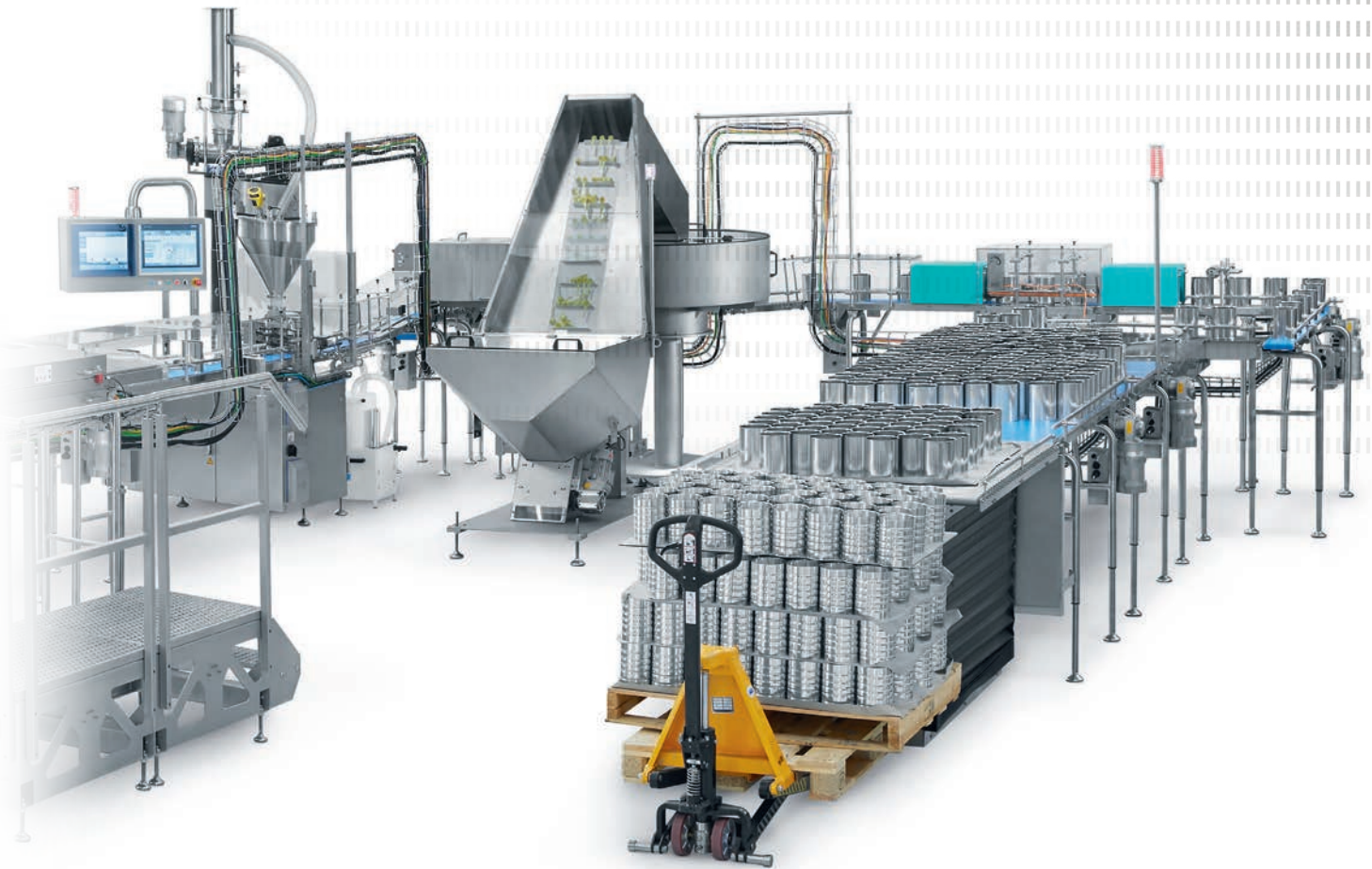

NORD - Your Global Partner for Reliable, Versatile Solutions for Packaging Machines.

Reliable Partner

Decades of experience configuring drives for special applications. NORD technology is made to last.

Efficient Engineering

Straight-structured system support and decentralized, intelligent integration saves time in engineering, purchasing, installation, and operation.

Connected

NORD drives can be directly connected to all common BUS systems and horizontally connected with decentralized solutions.

Drive Solutions for the Packaging Industry

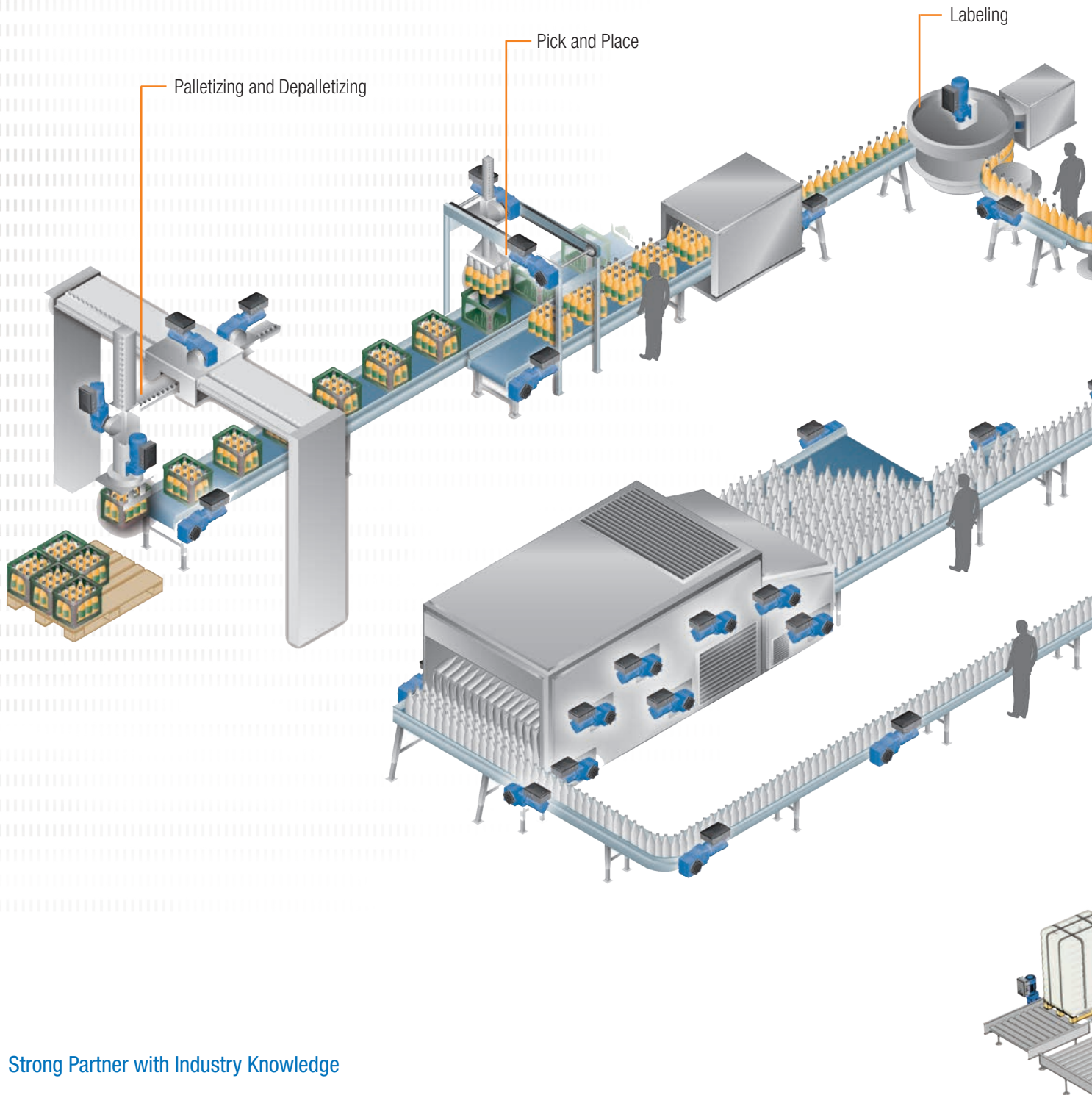

Strong Partner with Industry Knowledge

Manufacturers and operators of packaging machines and transport systems need a strong partner with great expertise in drive technology and profound industry knowledge in the packaging industry. NORD DRIVESYSTEMS is this reliable partner with in-house engineering teams to help you find the best solution for your applications.

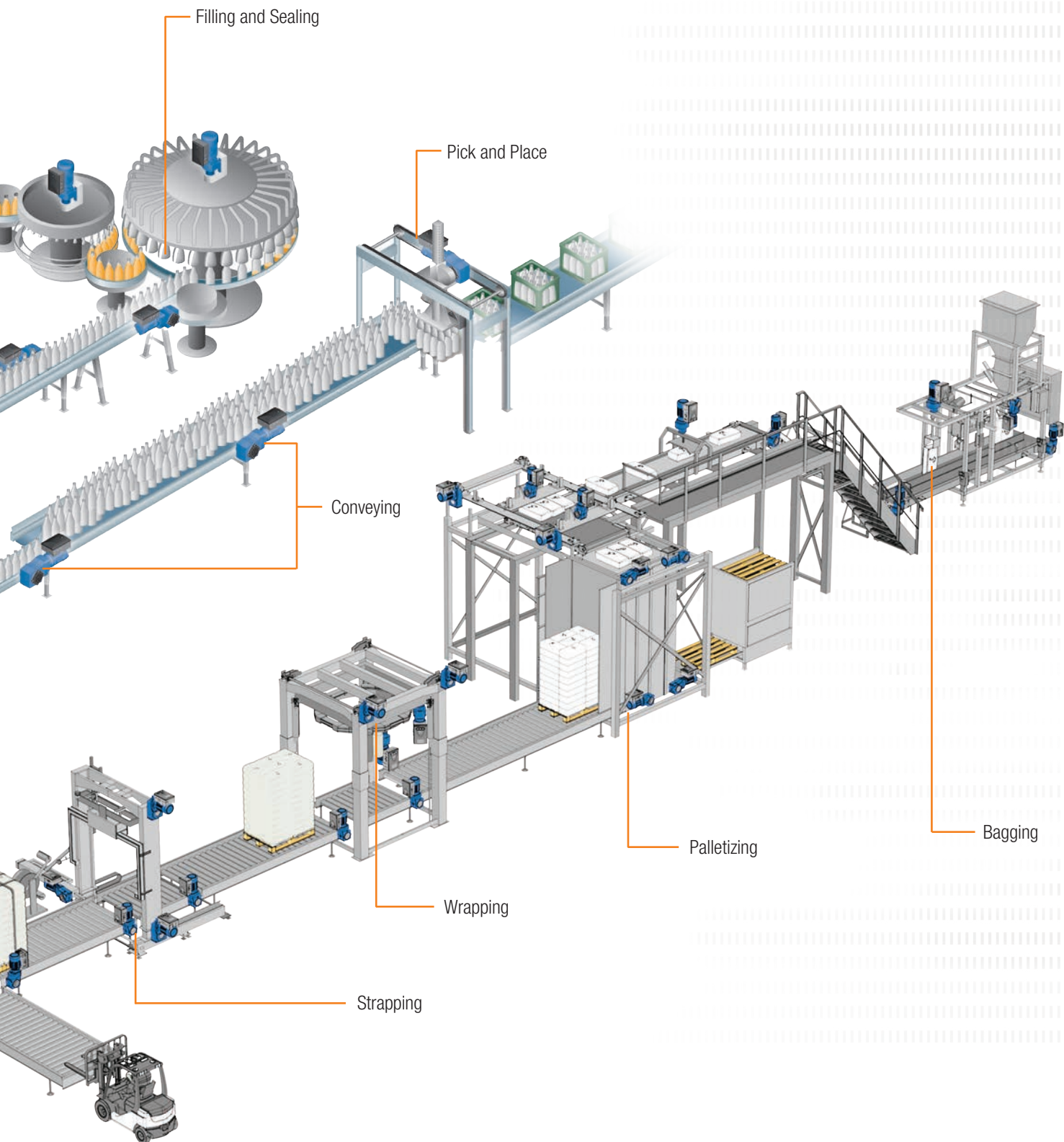

Drive Solutions for the Packaging Industry

From Start to Finish – NORD Moves your Packaging Machinery

Electric drives play an important role for packaging machines. They can be used to convey packaging material, drive tools, form and seal packages, and more. They are also essential for monitoring and controlling the overall packaging process.

NORD's electrical drive systems are easy to install, maintenance-friendly, energy-efficient, and can be quickly adapted to the needs of these applications. Their reliable operation ensures high efficiency and precise movements.



Primary Packaging

In primary packaging, food, pharmaceuticals, and other hygiene-sensitive products must be handled with care. Drive systems in these applications must be easy to clean, resistant to chemical cleaning agents, and protected against potential contamination. Focus is on positioning accuracy and chemical resistance in primary packaging.

NORD offers drive solutions for the following primary packaging processes:

- ▶ Forming
- ▶ Dosing
- ▶ Filling
- ▶ Sealing



Secondary Packaging

In comparison to pneumatic options, electrical drive systems are more efficient, have better precision and control, and allow for more energy efficiency within the system. Electric drives also have a longer service life and require less maintenance. For these applications, NORD DRIVESYSTEMS offers a wide portfolio of drive components including gear units, high-efficiency motors, and drive electronics that are perfectly matched to the requirements you specify.

Secondary packaging solutions provided by NORD include:

- ▶ Carton forming
- ▶ Filling
- ▶ Sealing
- ▶ Foiling
- ▶ Enveloping
- ▶ Shrinking



End-of-Line Packaging

In end-of-line packaging, heavy pallets, boxes, and containers are transported over long distances, requiring powerful, individual drive systems. NORD DRIVESYSTEMS offers drive components for all types of packaging, strapping, and palletizing machinery from a single source. Electric drives with higher rotor inertia ensure better motion control when moving heavy loads, especially with fast movements and dynamic load changes. They also enable high process stability, reduced vibrations, and decrease the risk of damaging the load or packaging machine.

NORD provides robust, reliable drives for end-of-line packaging applications, including:

- ▶ Palletizing/Depalletizing
- ▶ Wrapping
- ▶ Strapping



Higher-Level Applications

Through all processing stages in the packaging industry, transportation and provisioning processes play a decisive role. Whether individual units or larger containers are being transported, powerful, efficient drive systems are required and must be optimized for their respective applications. With NORD's wide range of modular products, we are able to select suitable solutions that can be individually adjusted to the respective requirements.

For higher-level applications, NORD offers drive solutions for the following processes:

- ▶ Conveying
- ▶ Pushing
- ▶ Rotating
- ▶ Packaging handling
- ▶ Labeling

Drive Solutions for the Packaging Industry

Palletizing Machines

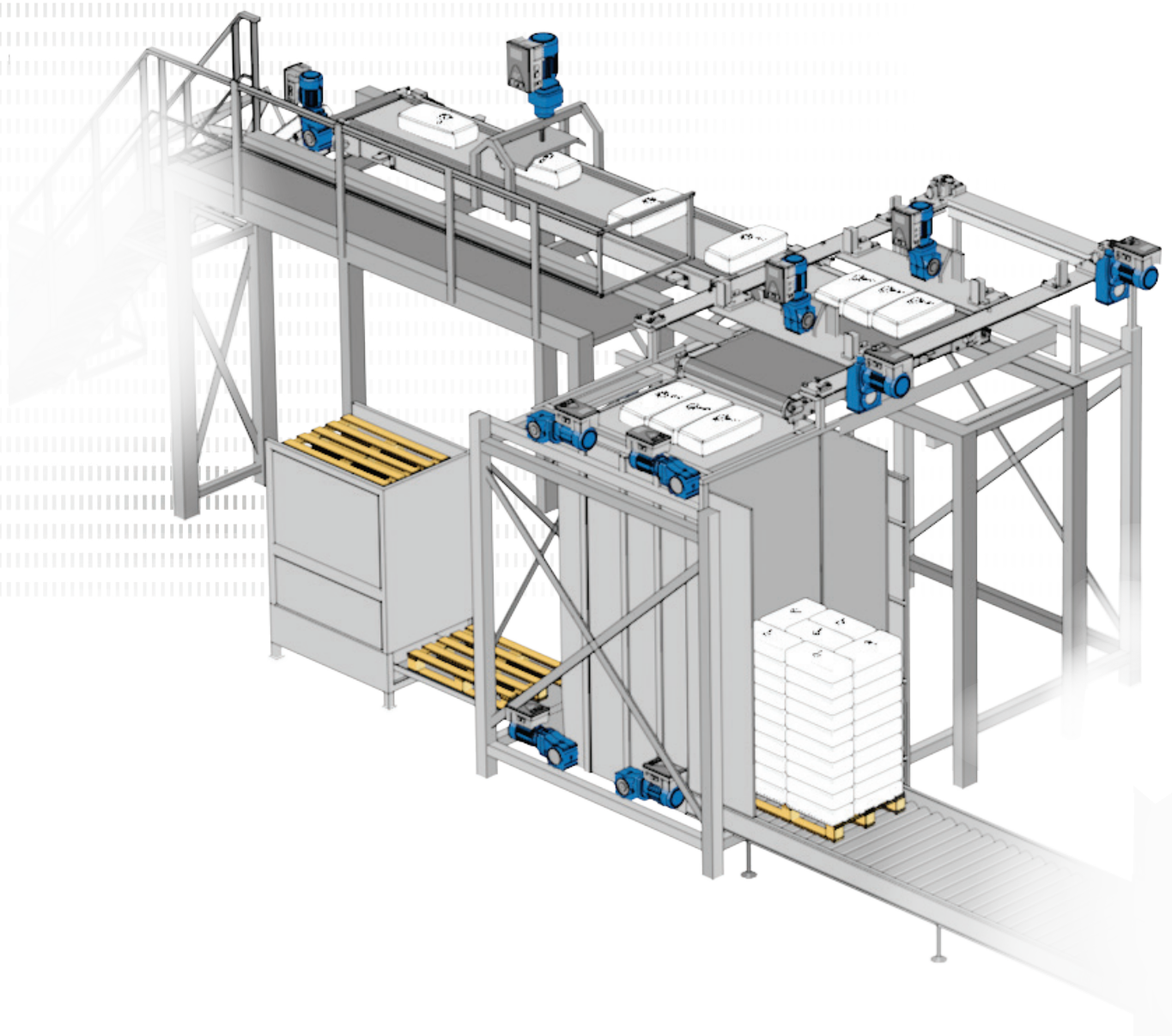

Layer Palletizing Machines

NORD technologies enable precise motion control and targeted drive design for various layer palletizing machines.

Creation of Layers (top view)

- ▶ 2x layer pusher
- ▶ 2x layer table actuation
- ▶ 2x format pusher

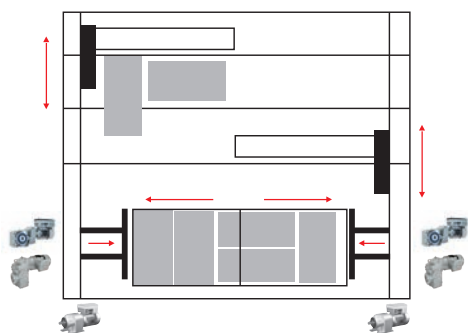

Pallet Lift (side view)

- ▶ 2x lift drive
- ▶ Roller conveyors

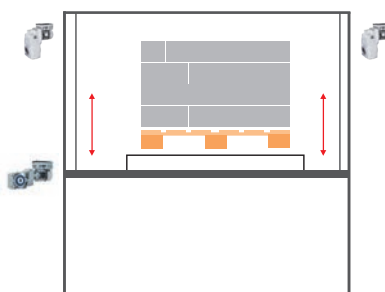

Pallet Magazine (side view)

- ▶ Magazine movement
- ▶ Magazine actuation

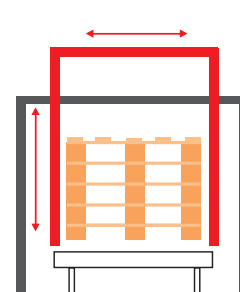

Gantry Palletizing Machines

For gantry palletizing machines, NORD delivers both flexibility and versatility. They not only reliably handle various packaging sizes and patterns, but also adapt seamlessly to varying production requirements.

Gantry Gripper (top view)

- ▶ X-axis
- ▶ Rotation gripper
- ▶ Y-axis
- ▶ Product infeed

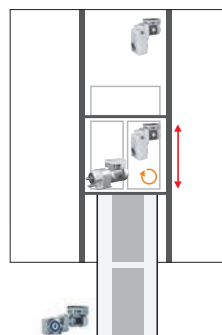

Layer Table (top view)

- ▶ Opening
- ▶ Pusher

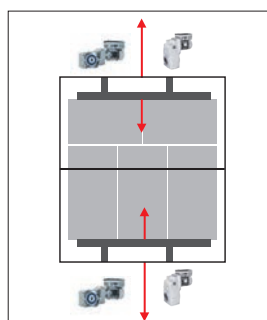

Pallet Lift (side view)

- ▶ 2x lift drive
- ▶ Roller conveyors

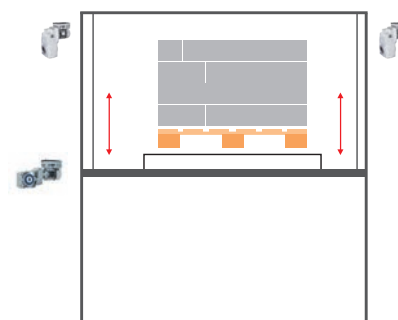

Linear Palletizing Machines

NORD's innovative drive solutions increase throughput and reduce the Total Cost of Ownership (TCO) for linear and other automated palletizing machines. They are highly-configurable to adapt to a wide range of application requirements.

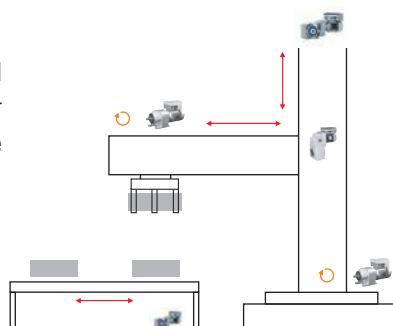

Axis Drives

- ▶ Rotation gripper
- ▶ Y-axis: gripper drive
- ▶ Z-axis: arm drive
- ▶ Arm rotation

Drive Solutions for the Packaging Industry

Wrapping Machines

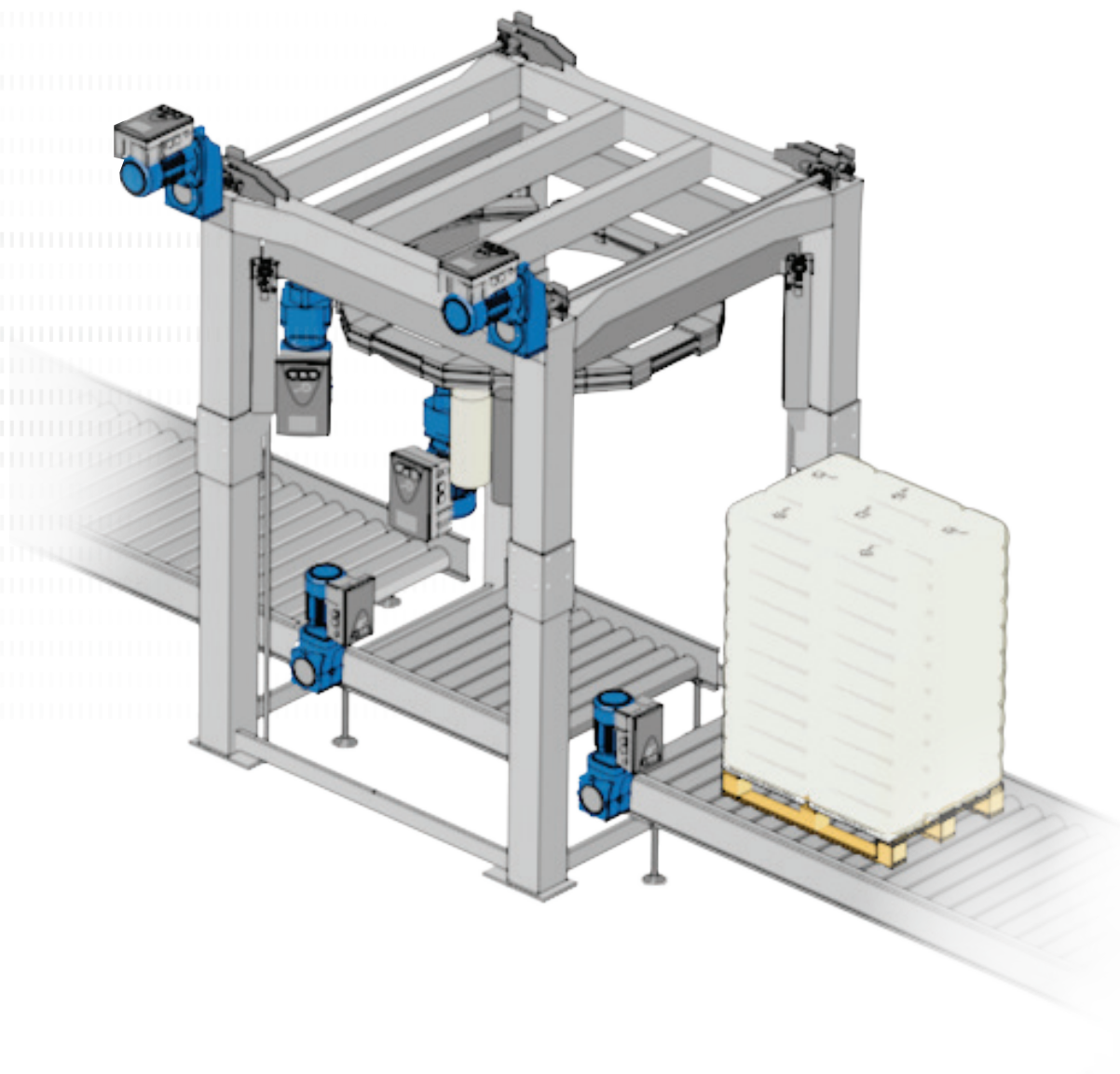

Stretch Hood Wrapping Machines

The dynamic movement of strapping machines require intelligent drive solutions with reliable performance. NORD's modular products are highly configurable to ensure maximum versatility and adaptability to each part of the overall system.

Film Infeed and Sealing
(side view)

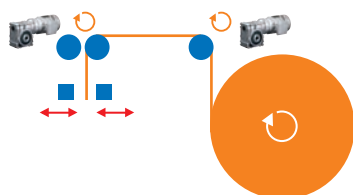

Film Opening (top view)

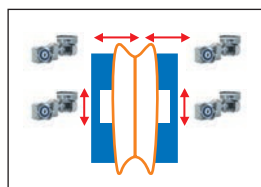

Horizontal Film Stretching:
Film Feed and Stretching Units
(top view)

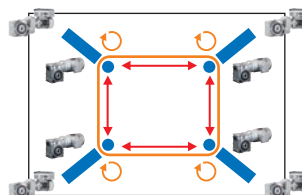

Vertical Film Stretching
(side view)

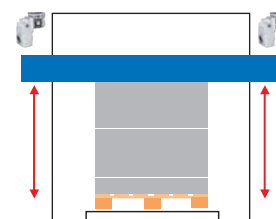

Ring Wrapping Machines

NORD's decentralized electronic products provide ring wrapping machines with high efficiency, precise positioning, and speed control while significantly reducing the amount of wiring for a clean environment and minimizing the need for large control cabinets.

Ring Gantry Drive and Film Handling

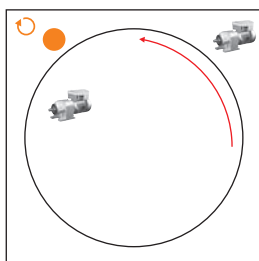

Vertical Height Adjustment for Ring Gantry

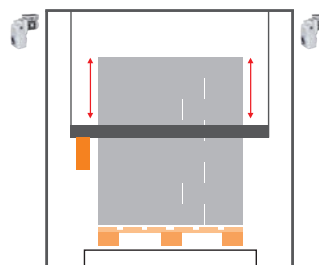

Arm Wrapping Machines

NORD offers cost-effective, flexible, and robust drive solutions that are specifically matched to the requirements of arm wrapping machines. Even with the small number of drives required, NORD products can be optimized for added operational efficiency.

Arm Drive and Film Dispenser (top view)

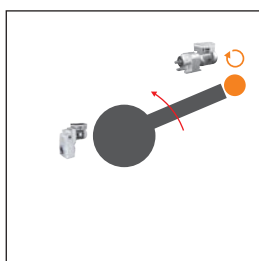

Height Adjustment for Film Dispenser (side view)

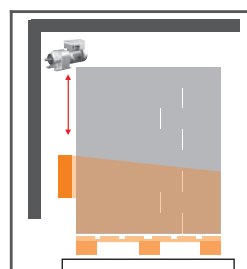

Drive Solutions for the Packaging Industry

Strapping Machines

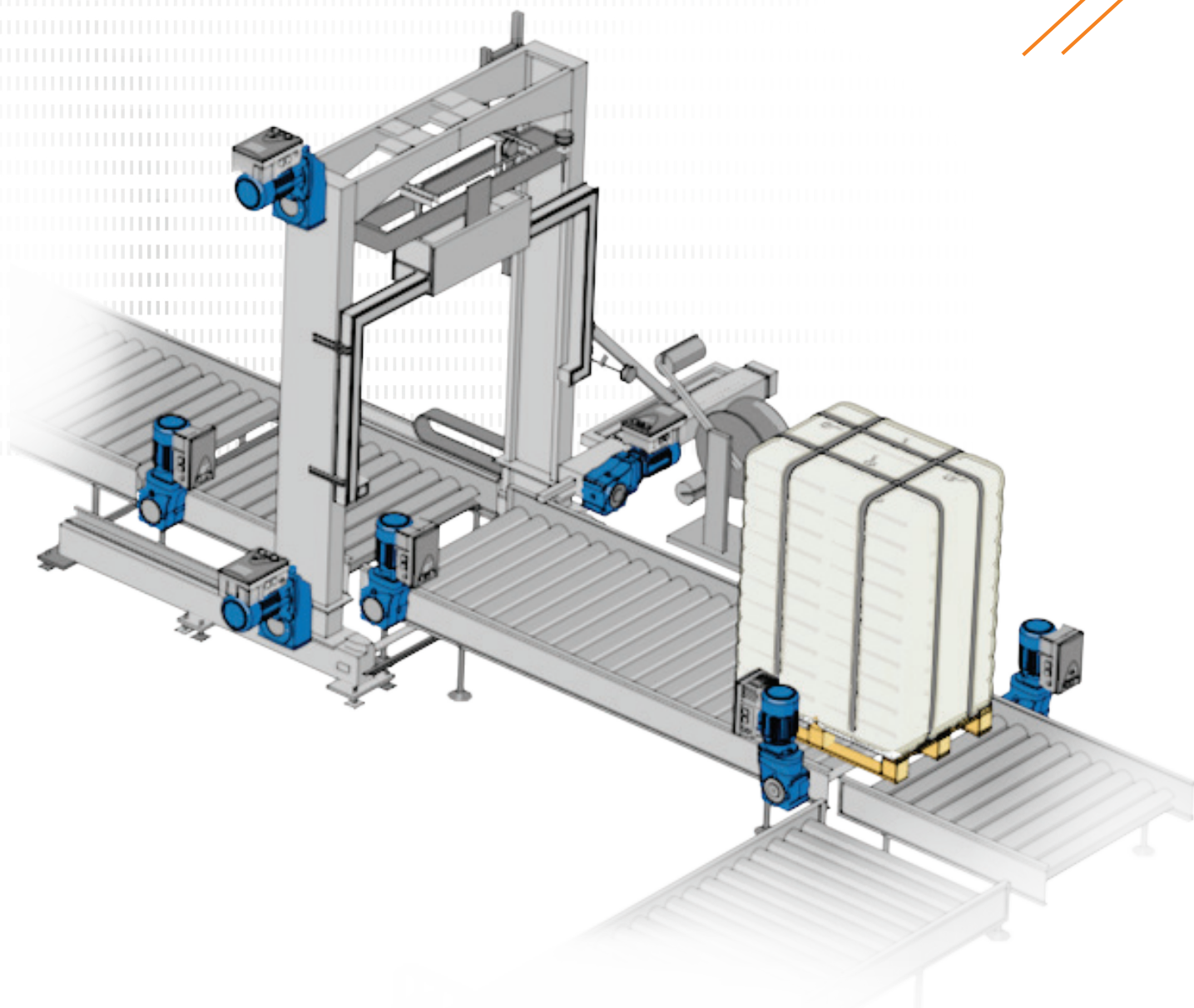

Horizontal Strapping Machines

Precise positioning and control is essential for strapping machines to secure a wide range of product forms and sizes. NORD offers adaptable solutions that are not only enable flexible, safe strapping, but also reduce the number of components used.

Gantry Drive (side view)

- ▶ Height adjustment
- ▶ Product infeed
- ▶ Roller conveyors

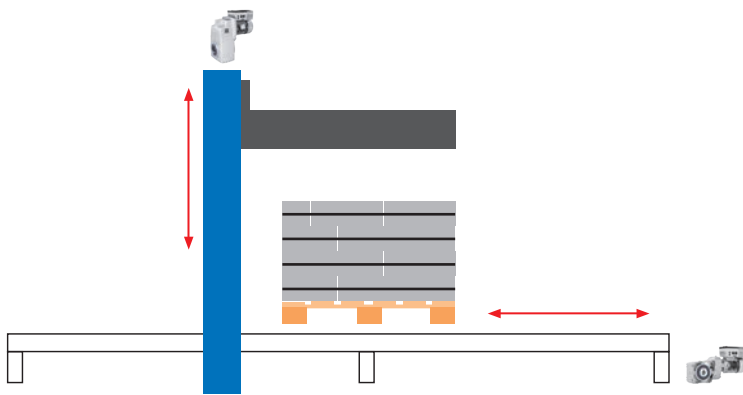

Strapping Gantry top view)

- ▶ Locking
- ▶ Strap infeed

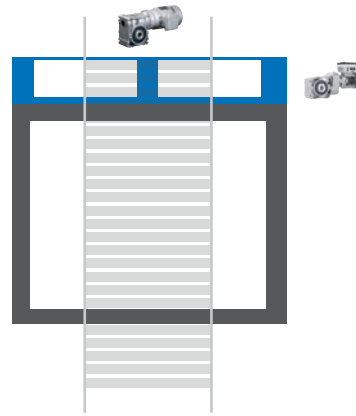

Vertical Strapping Machines

Gantry Height Adjustment (side view)

- ▶ Product infeed

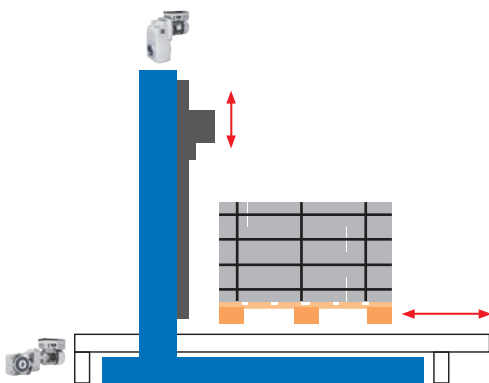

Strap Infeed (top view)

- ▶ Actuation
- ▶ Gantry travel drive

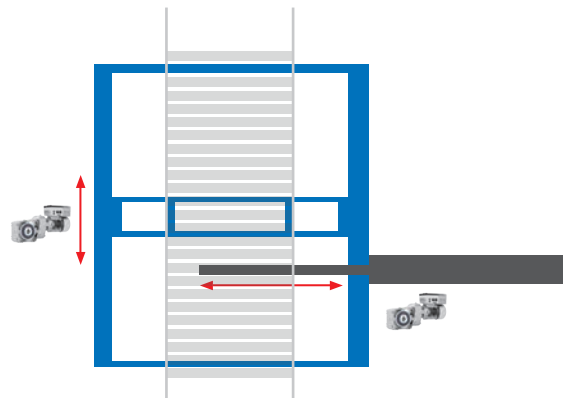

Drive Solutions for the Packaging Industry

Pouch Sorters

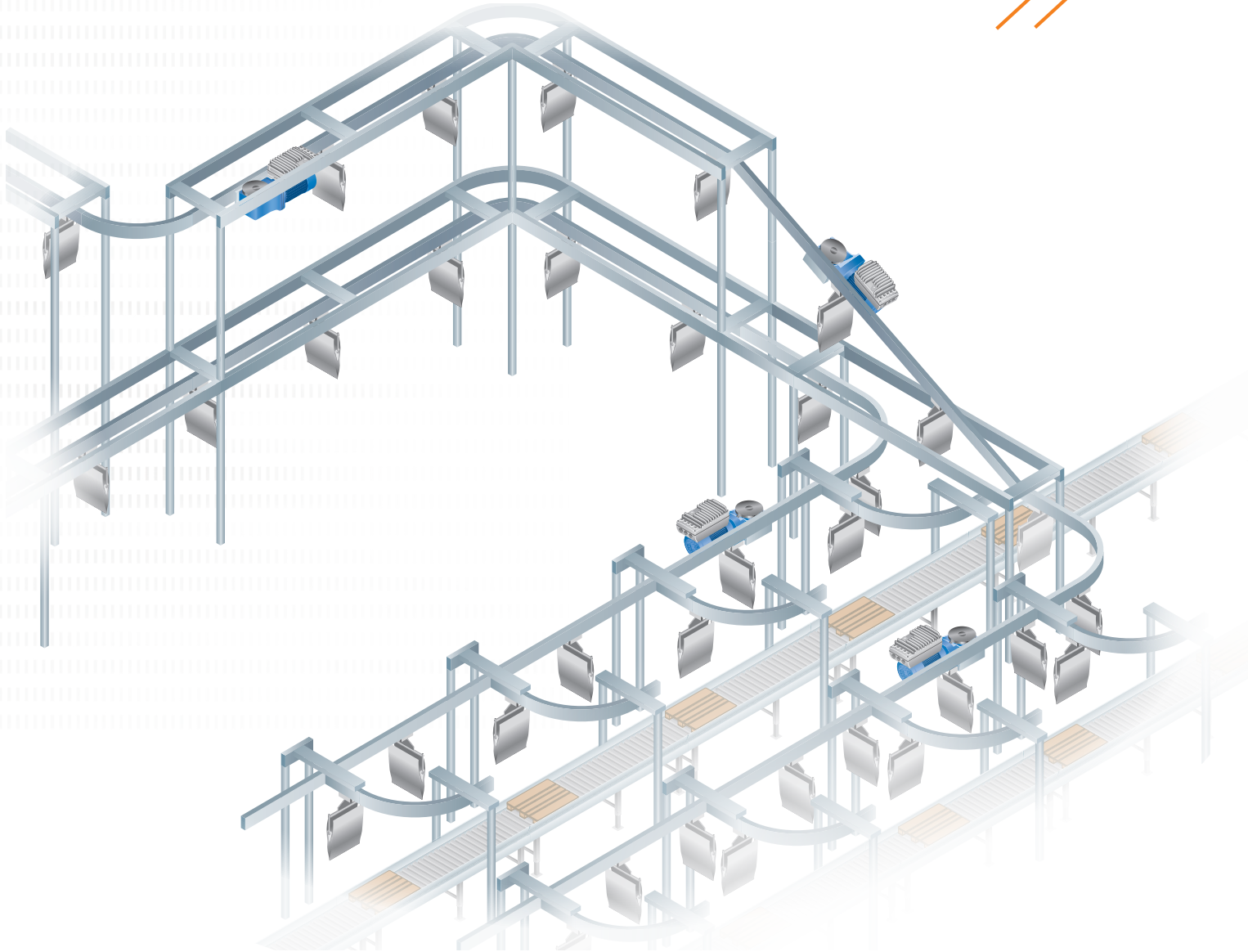

Pouch Sorters

High efficiency and flexibility for circular, linear, and other pouch sorters is achieved through NORD gear motors combined with lightweight, decentralized drives directly attached to the overhead conveyors. These compact systems optimize space utilization of storage areas and enable a seamless process chain up to the packaging station.

The NORD Solution

NORD offers compact, low-maintenance drive solutions for pouch sorters that result in a minimum number of drive variants and quiet, energy-efficient operation. The standard solution for these systems includes:

- ▶ Energy-efficient UNIVERSAL motors certified according to CE, UL, CSA, CCC, ISI, and EAC standards that can be used worldwide. When a variable frequency drive is used, the motor can be operated on a 50 Hz / 60 Hz mains supply.
- ▶ Bevel and worm gear units constructed with one-piece, compact housings are able to absorb large axial forces due to their reinforced bearings.
- ▶ NORDAC *ON* variable frequency drives designed specifically for horizontal conveyor technology. These decentralized, compact, Plug-and-Play compatible units include an integrated multi-protocol Ethernet interface to reduce system variants, save space, and lower operating costs.

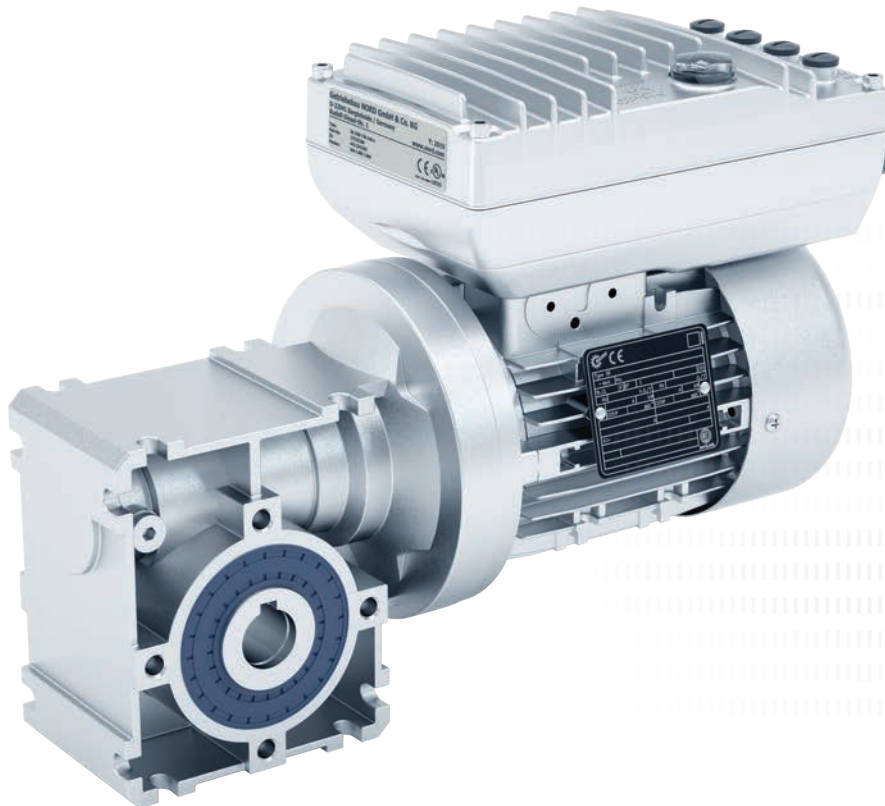

Drive Solutions for the Packaging Industry

Pallet Conveyors

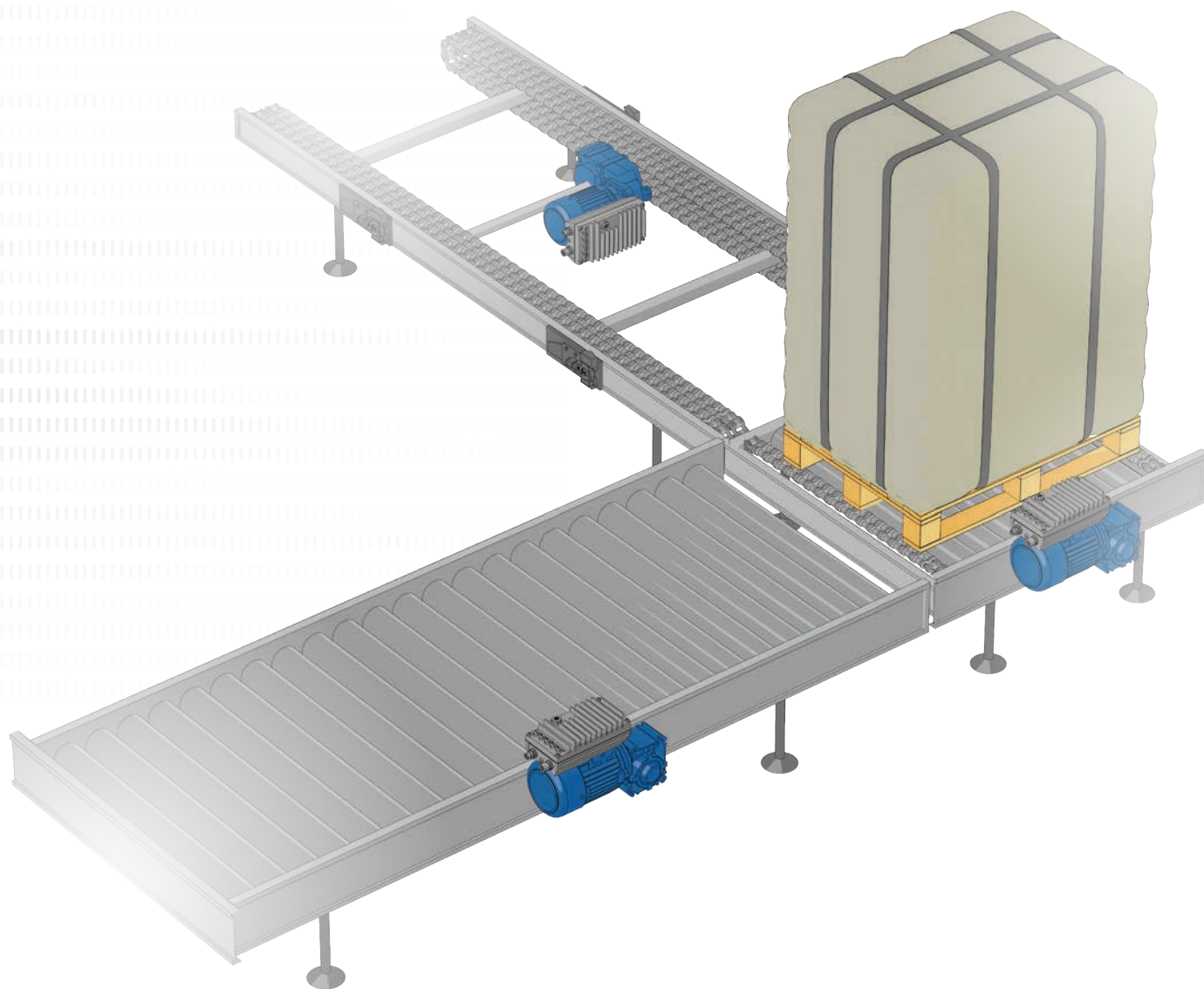

Pallet Conveyors

NORD gear motors combined with decentralized VFDs are ideal for intralogistics transport within a facility. These solutions deliver constant torque over a wide speed range to reliably move varying load sizes via chain conveyors, roller conveyors, corner transfer conveyors, turntables, transfer trolleys, lifters, palletizing/depalletizing machines, infeed/outfeed stations, and more.

The NORD Solution

NORD's LogiDrive solution for warehouses uses a NORDAC *ON*VFD for Ethernet applications and a NORDAC *FLEX*VFD for other applications. The solution is rounded off with a high-efficiency IE3 87 Hz universal motor or an IE5+ synchronous motor. The LogiDrive complete drive solution is available for for all common gear unit types and can be configured to match precise application requirements.

LogiDrive Characteristics

- ▶ Compact design
- ▶ Standardized
- ▶ Brake control
- ▶ High overload capacity
- ▶ Smooth, gentle start and stop
- ▶ Decentralized VFDs (ASI bus or Ethernet)
- ▶ Service-friendly (Plug-and-Play, short replacement time)
- ▶ Global certification

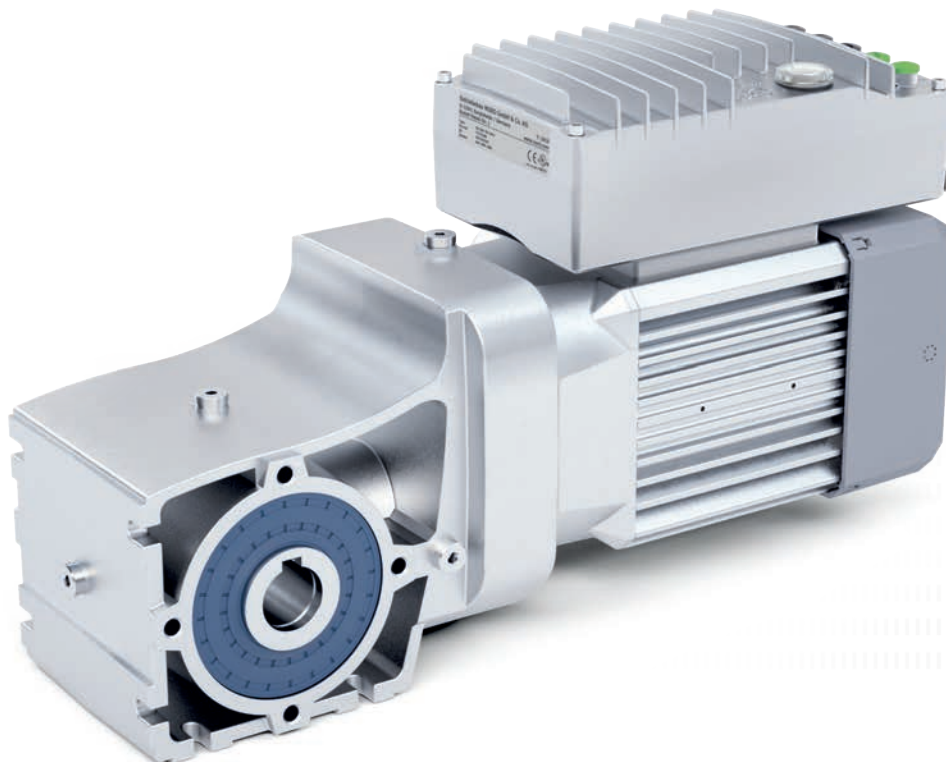

Drive Solutions for the Packaging Industry

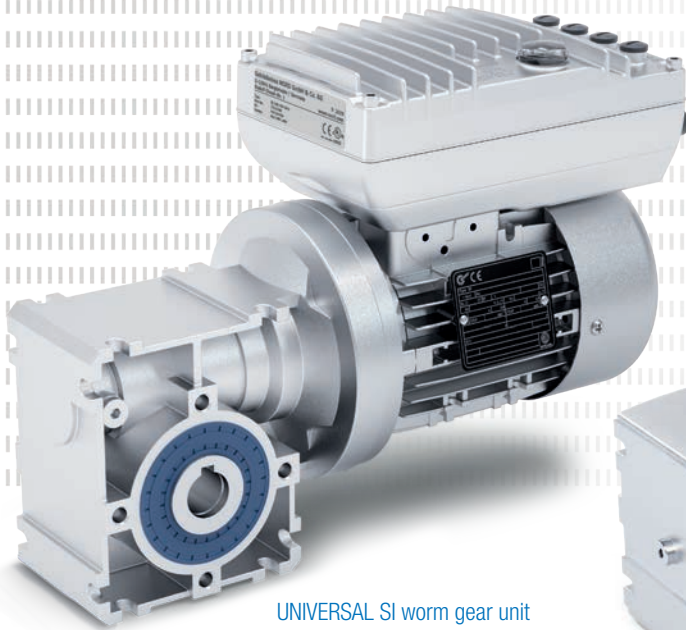

UNIVERSAL SI worm gear unit
IE3 motor
NORDAC ON VFD

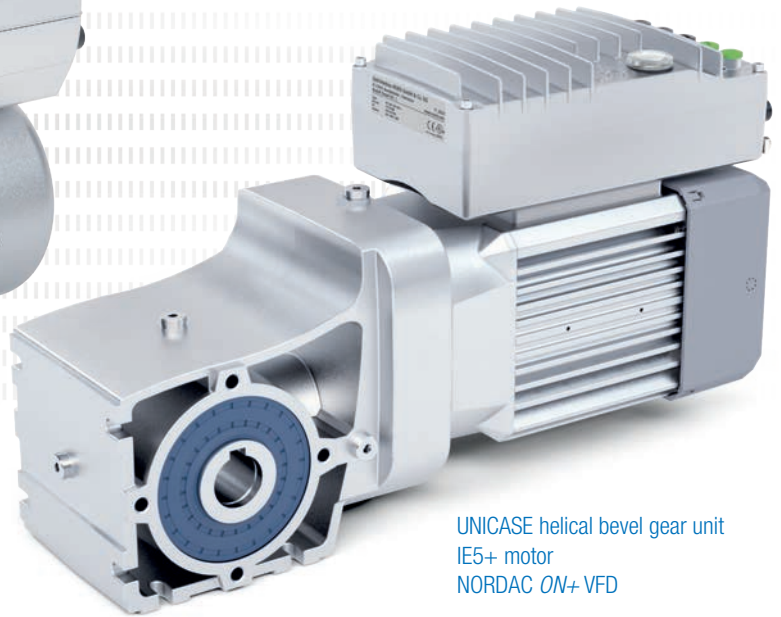

UNICASE helical bevel gear unit
IE5+ motor
NORDAC ON+ VFD

NORD Electric Motors

NORD's high-efficiency electric motors are produced in-house and offer a high degree of robustness, reliability, and flexibility. They are compatible with our full line of gear units and variable frequency drives and feature extensive configuration options including encoders, brakes, sensors, and more.

- ▶ IE3 motors from 0.16 – 75 hp (sizes 63 – 250)
- ▶ IE4 synchronous and asynchronous motors from 1.50 – 7.50 hp (Sizes 80 – 100)
- ▶ Global approvals and acceptance
- ▶ Various motor protection options
- ▶ Direct motor mounting options
- ▶ High gear ratios

IE5+ PMS Motors

The new IE5+ motor generation is designed for minimizing variants and reducing operating costs using the highest operational efficiency with IE5+ technology. The motors deliver constant torque over a wide speed range and maintain consistent efficiency even at partial load and low speed ranges.

- ▶ Power range: Ventilated (TEFC): 0.50 – 5.00 hp
Non-ventilated (TENV): 0.50 – 3.00 hp
- ▶ Reduced TCO and fast ROI
- ▶ Fully matched NORD modular system solution with gear unit, motor, and variable frequency drive
- ▶ Brake with or without hand release
- ▶ Different encoder options for closed loop
- ▶ Available with temperature sensor

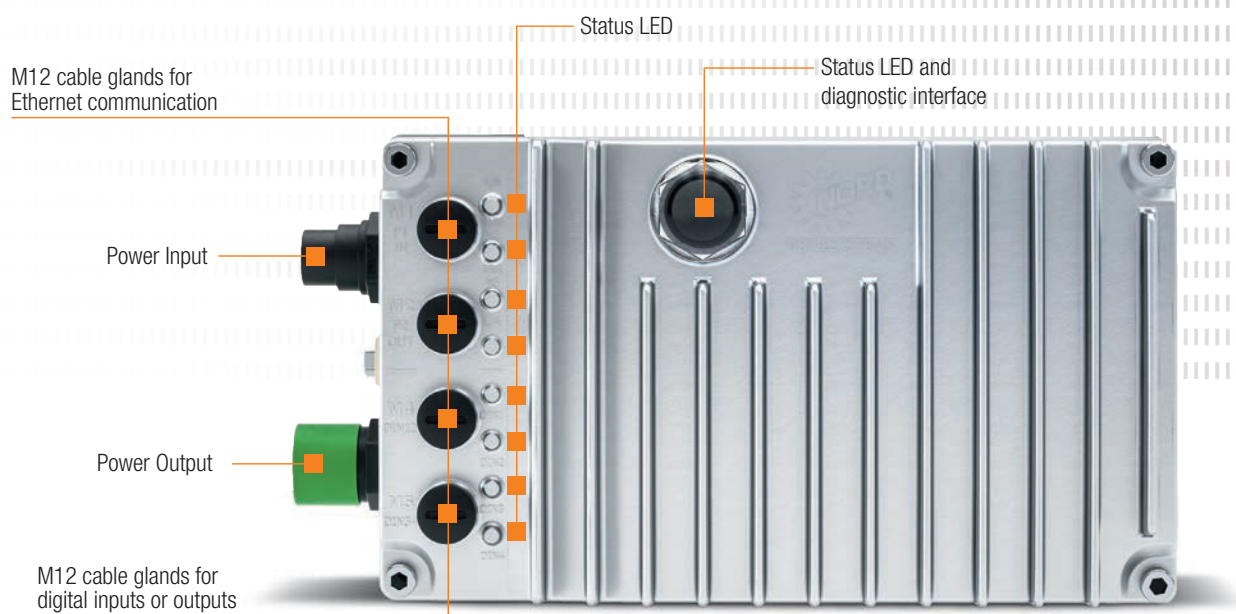

NORDAC ON/ON+ VFDs

NORDAC ON/ON+ decentralized variable frequency drives are designed for the special requirements and varying needs of packaging applications. The NORDAC ON has been developed for IE3 gearmotors while the NORDAC ON+ has been optimized for use with IE5+ synchronous gearmotors.

- ▶ Power range: 0.50 – 4.00 hp
- ▶ Protection class: IP55, IP66
- ▶ Wall of motor mounting
- ▶ Multi-protocol Industrial Ethernet interface
- ▶ Full Plug-and-Play compatibility
- ▶ Economic solution for IIoT environments

Scan for more information:



M7000 –
Asynchronous
Motors



M5000 –
IE5+ Synchronous
Motors



E3000 –
NORDAC Electronic
Drive Technology

Drive Solutions for the Packaging Industry

LogiDrive®

The service-friendly, standardized modular system utilizes NORD products customized to respective industry standards and application requirements. For every area, there are advanced versions with IE5+ permanent magnet synchronous motor technology and a basic version with IE3 asynchronous motors. While the LogiDrive advanced drives address issues such as energy efficiency, version reduction, and Total Cost of Ownership (TCO), the basic LogiDrive's main focus is on cost efficiency.

Advanced

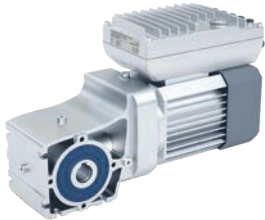

Advanced



Advanced



Advanced

- ▶ Focus on energy efficiency, variant reduction, and Total Cost of Ownership (TCO)
- ▶ IE5+ permanent magnet synchronous motors
- ▶ Decentralized variable frequency drive
- ▶ Expandable through optional module
- ▶ Plug-and-Play
- ▶ PLC functionality for drive-related functions

Basic

- ▶ Main focus is cost efficiency
- ▶ IE3 high efficiency motor
- ▶ Decentralized variable frequency drive
- ▶ Flexible gear unit selection - modular
- ▶ Encoder optional
- ▶ PLC functionality for drive-related functions

Basic

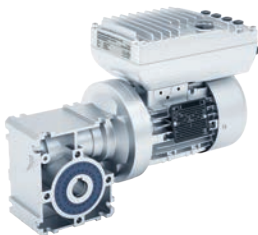

Basic



Efficiency at Full Load and Partial Speed

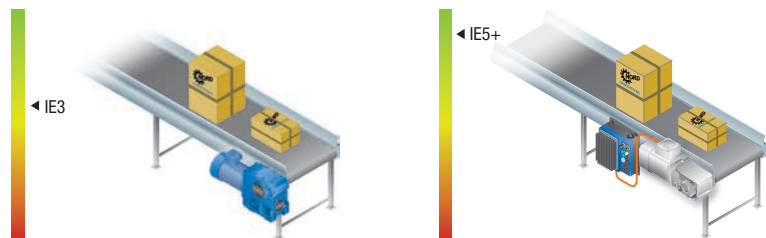

Motor Size	IE3	IE5+
71	0.33 - 0.5 hp	0.5 - 3.0 hp
80	0.75 - 1.0 hp	0.5 - 3.0 hp
90	1.5 - 2.0 hp	1.5 - 4.0 hp
100	3.0 - 4.0 hp	1.5 - 5.0 hp

3 x AC 400V

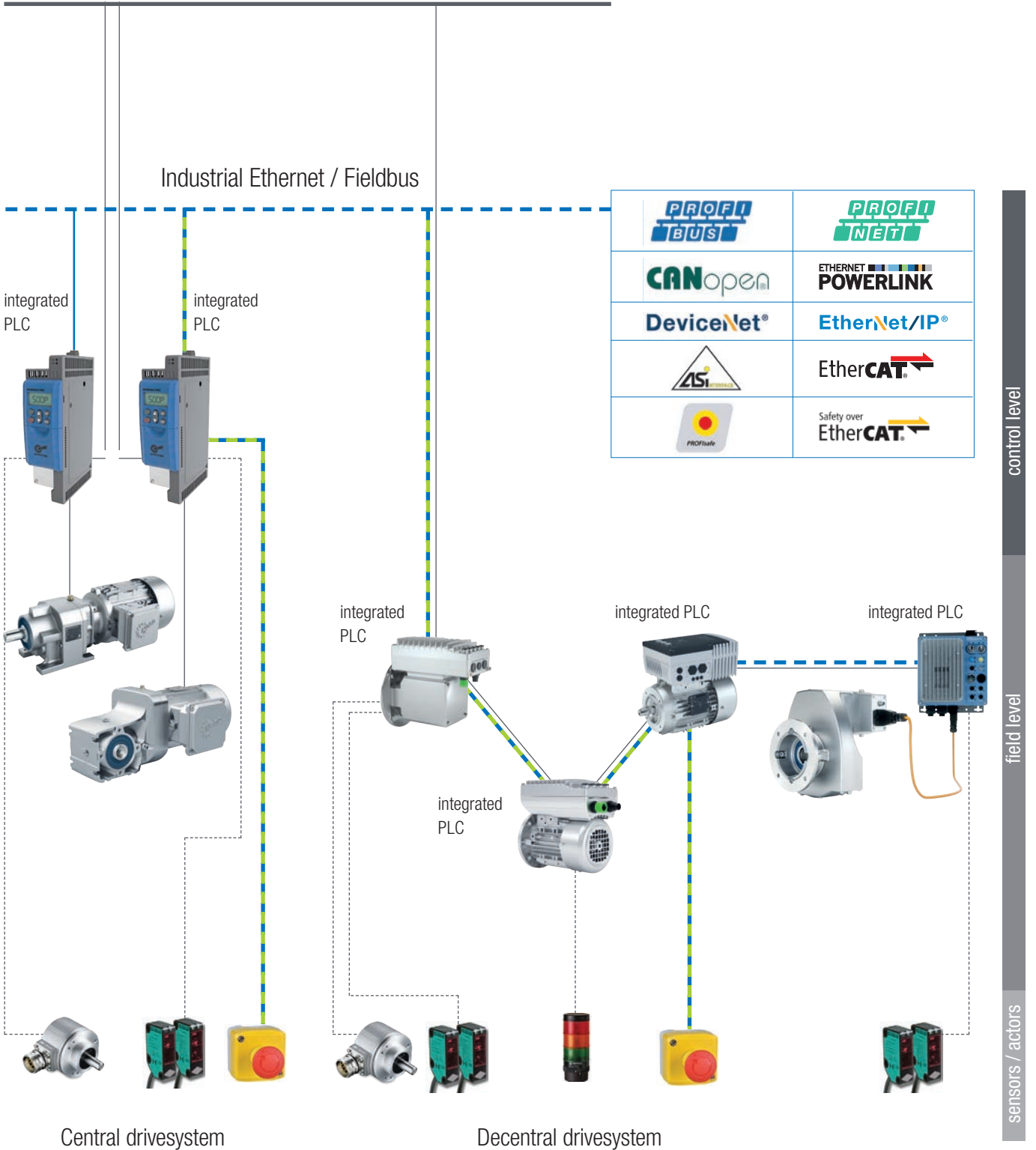

Drive Solutions for the Packaging Industry

NORDBLOC.1® Helical Inline Gear Units (Catalog G1000)

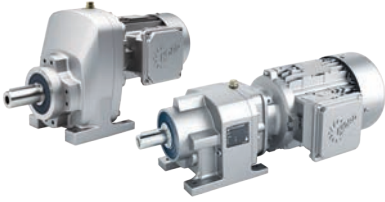

- ✓ Foot or flange-mounted
- ✓ UNICASE housing
- ✓ Die-cast iron or aluminum housing
- ✓ Available in single, double, or triple reduction

Sizes: 16
Power: 0.16 – 50 hp
Torque: 266 – 29,207 lb-in
Ratio: 1.07:1 – 456.77:1

NORDBLOC.1® 2-Stage Helical Bevel Gear Units (Catalog G1000)



- ✓ Foot, flange, or shaft mounted
- ✓ Aluminum housing
- ✓ Hollow or solid shaft
- ✓ Compact design

Sizes: 6
Power: 0.16 – 10 hp
Torque: 443 – 5,842 lb-in
Ratio: 3.03:1 – 70:1

UNIVERSAL SI/SMI Worm Gear Units (Catalog G1000)



- ✓ Smooth surface aluminum housing
- ✓ Life-long lubrication
- ✓ Universal mounting design
- ✓ NEMA, IEC, or direct motor mount options

Sizes: 5
Power: 0.16 – 5.00 hp
Torque: 186 – 3,780 lb-in
Ratio: 5.00:1 – 3,000.00:1

DuoDrive Integrated Gear Unit and Motor (Catalog G5010)



- ✓ Integrated gear unit and motor
- ✓ Simple plug-and-play commissioning
- ✓ System efficiency up to 92%
- ✓ High power density

Sizes: 2
Power: 0.50 – 4.00 hp
Torque: 230 – 2,186 lb-in
Ratio: 3.24:1 – 18.1:1

NORDAC® START SK 135E Motor Starters (Catalog E3000)



- ✓ Integrated electronic brake rectifier
- ✓ Reversing starter with soft start function
- ✓ Consistent parameter structure

Sizes: 2
Voltage: 3~ 200 – 240 V, 3~ 380 – 500 V
Power: 0.16 – 4 hp resp. up to 10 hp

NORDAC® FLEX SK 200E Variable Frequency Drives (Catalog E3000)



- ✓ Energy saving function
- ✓ Integrated PLC
- ✓ Integrated POSICON positioning control

Sizes: 4
 Voltage: 1~ 110 – 120 V, 1~ 200 – 240 V, 3~ 200 – 240 V, 3~ 380 – 500 V
 Power: 0.33 – 30 hp

NORDAC® LINK SK 250E Field Distributors (Catalog E3000)



- ✓ Variable frequency drive or motor starter
- ✓ All connections in plug-in version for easy commissioning and maintenance
- ✓ PLC functionality for drive-integrated functions

Sizes: 3
 Voltage: 3~ 380 – 500 V
 Power: VFD 0.75 – 10 hp; Motor starter 0.16 – 4 hp

NORDAC® ON/ON+ SK 300P Variable Frequency Drives (Catalog E3000)

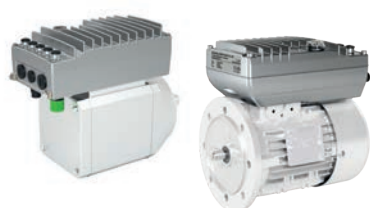

- ✓ Wall or motor mounted
- ✓ Compact design
- ✓ Ethernet communication
- ✓ Plug-and-Play solution

NORDAC ON
 Sizes: 3
 Voltage: 3~ 400V
 Power: 0.50 – 3 hp

NORDAC ON+
 Sizes: 3
 Voltage: 3~ 400V
 Power: 0.50 – 4 hp

NORDAC® PRO SK 500P Variable Frequency Drives (Catalog E3000)



- ✓ Precise current vector control with high overload reserves for operating asynchronous and synchronous motors
- ✓ Universal interface for real time Ethernet
- ✓ Integrated PLC for drive-related functions even in the basic device

Size: 5
 Voltage: 1~ 200 – 240 V, 3~ 380 – 480 V
 Power: 0.33 – 30 hp

NORDAC® PRO SK 500E Variable Frequency Drives (Catalog E3000)



- ✓ Stand-alone operation
- ✓ Sensorless current vector control (ISD control)
- ✓ 4 parameter sets
- ✓ Integrated PLC

Size: 11
 Voltage: 1~ 110 – 120 V, 1~ 200 – 240 V, 3~ 200 – 240 V, 3~ 380 – 480 V
 Power: 0.33 – 200 hp

Drive Solutions for the Packaging Industry



Wild Goose Bottle filling line

“Their dependability is huge, along with the customer support that NORD provides worldwide. With big packaging lines, it’s bad when the bottling line goes down. If this does happen, you can count on NORD to have spare parts delivered quickly.”

Roger Walz
Vice President of Sales, Wild Goose Filling

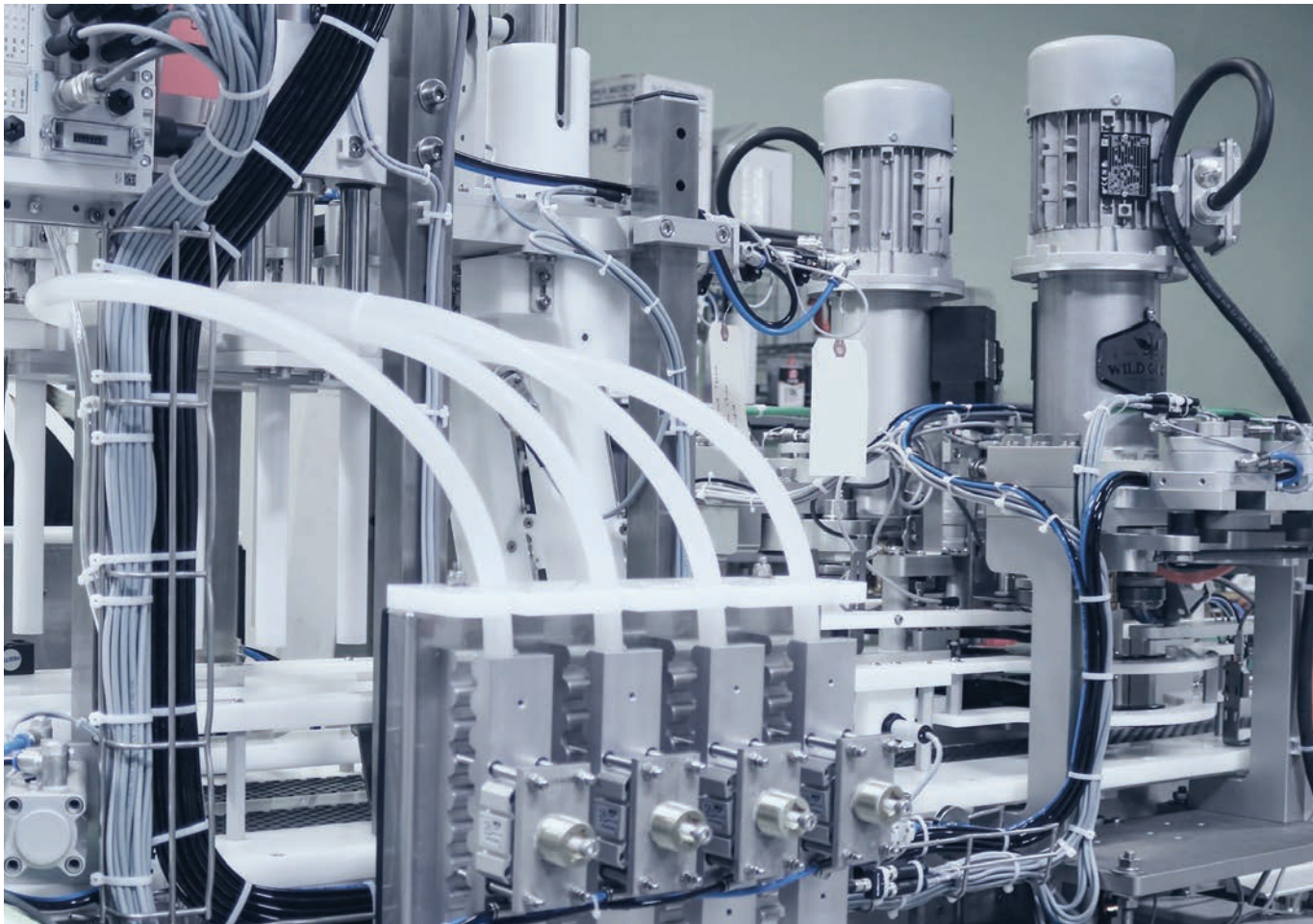

Drive Solutions for the Packaging Industry



SYMACH Palletizing Machine

“NORD played an important role as our supplier and consultant”, says Bakker. “A supplier who supports you and thinks along the same lines provides a great opportunity. This was precisely the case with NORD. Not the quality of the products alone was decisive for us, but also the good relationships which we have built over the past years with NORD as our global partner.”

Sacha Bakker,
Managing Director and co-owner of the Dutch engineering company SYMACH

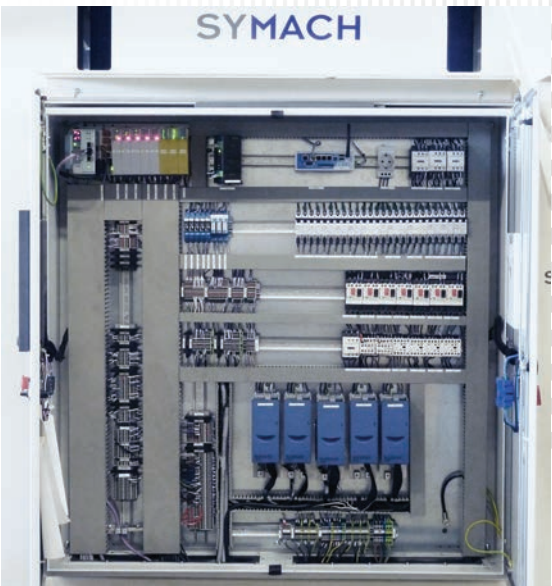

Ordering is Easy With myNORD Online Tools!

- ▶ Obtain drawing files direct from quote configuration
- ▶ Effortlessly select & configure customized drive solutions
- ▶ Create quotes with account-specific net pricing
- ▶ Order-specific documentation
- ▶ 24/7/365 order tracking
- ▶ Select and order spare parts

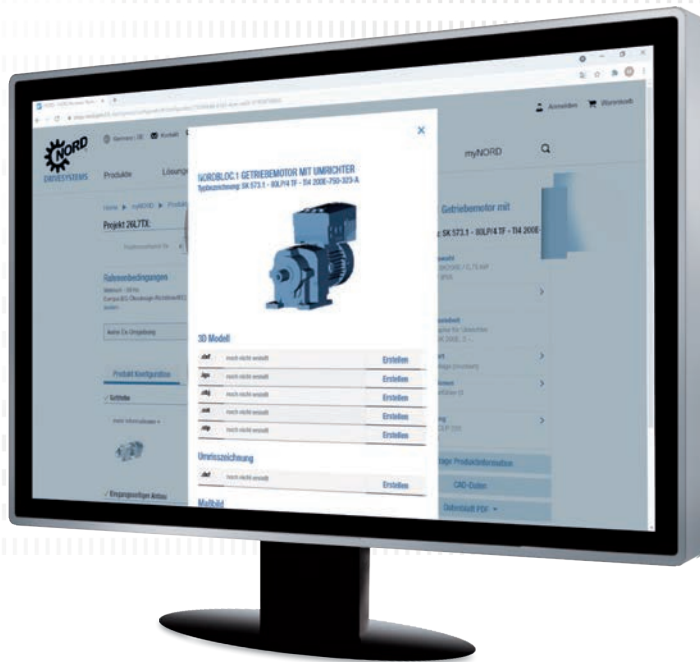

Register now at myNORD.com!

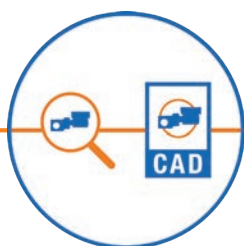

US

Central Region
Corporate Headquarters
800 NORD Drive
Waunakee, WI 53597
Tel. 888.314.6673
info.us@nord.com
www.nord.com

East Region
300E Forsyth Hall Dr.
Charlotte, NC 28273
Tel. 888.314.6673
info.us@nord.com

West Region
1180 Railroad St.
Corona, CA 92882
Tel. 888.314.6673
info.us@nord.com

South Region
350 Cypress Hill Dr, Suite 400
McKinney, TX 75071
Tel. 888.314.6673
info.us@nord.com

CA

NORD Gear Limited
Brampton, ON
41 West Drive
Brampton, ON L6T4A1
Tel. 800.668.4378
info.ca@nord.com

MX

NORD DRIVE SYSTEMS SA DE CV
Queretaro, Mexico
Av. Industria Textil B.6
Parque Industrial PYME, Huimilpan
QRO - Mexico 76950
Tel. 52 442 688 7110
info.mx@nord.com