

EN

DuoDrive G5010



DRIVESYSTEMS

Our Solution. Your Success.

NORD DRIVESYSTEMS Group

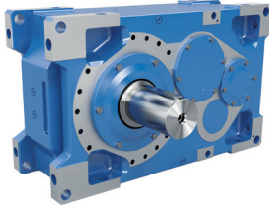

Industrial gear units

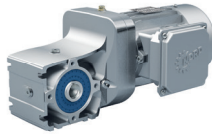

Geared motors



Frequency inverters and motor starters

- ▶ Headquarters and technology centre in Bargteheide, near Hamburg
- ▶ Innovative drive solutions for more than 100 branches of industry
- ▶ 7 production locations with cutting edge technology produce gear units, motors and drive electronics for complete drive systems from a single source
- ▶ NORD has 48 subsidiaries in 36 countries and further sales partners in more than 50 countries. They provide local stocks, assembly centres, technical support and customer service
- ▶ More than 4,700 employees throughout the world create customised solutions



Introduction	2 - 3
Drive informations	4 - 12
Gear-Options	14 - 19
Motor-Options	20 - 25
Performance data	26 - 27
Motor data	28
Motor characteristics	30 - 37
Dimensioned drawing	38 - 49

DuoDrive

NEW

The seamless integration of motor and gearbox is a quantum leap in drive technology and sets new standards in terms of energy efficiency and user-friendliness.



Integrating is more efficient than combination.

NORD DuoDrive is a revolutionary integrated geared motor concept in a hygienic wash-down design. It combines the highly efficient IE5+ motor with a single-stage inline gear in one housing.

With optimized system efficiency, high power density and very low noise emissions, it is particularly suitable for users in the areas of intralogistics, food and pharmaceutical industries.

Together with the simple plug-and-play commissioning, there is a significant reduction in the total cost of ownership (TCO) compared to other drive systems.

NORD DuoDrive to reduce operating costs and variety:

- ▶ Highest system efficiency
- ▶ Reduced total cost of ownership (TCO) and faster return on investment (ROI)
- ▶ Reduction in variants is possible thanks to constant torque over a wide speed range
- ▶ Particularly easy to clean, with high corrosion resistance thanks to the smooth and fanless design
- ▶ Compact and hygienic design for ultimate versatility
- ▶ Fewer wearing parts reduce maintenance costs

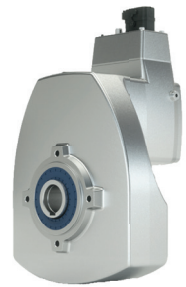

Features:

- ▶ Latest generation permanent magnet synchronous motor (PMSM)
- ▶ Power range from 0.35 to 3.00 kW
- ▶ Hygienic design
- ▶ Flexible mounting options: B5 flange, B14 flange, GRIPMAXX
- ▶ Speed range from 0 to 3,000 rpm
- ▶ Optional incremental encoder and mechanical brake

Further information can be found in:

Application Guide - PMSM - Drive Optimization AG0101



Drive informations

Norms and Standards

The NORD motors comply with the IEC 60034 series of standards and meet the other standards.

Norm	Synchronous Motors	Asynchronous Motos
IEC 60034-1, EN 60034-1	X	X
IEC 60034-2-1, EN 60034-2-1	X	X
IEC 60034-5, EN 60034-5	X	X
IEC 60034-7, EN 60034-7	X	X
IEC 60034-8, EN 60034-8	X	X
IEC 60034-9, EN 60034-9	X	X
IEC 60034-11, EN 60034-11	X	X
IEC 60034-12, EN 60034-12		X
IEC 60034-14, EN 60034-14	X	X
IEC 60034-18-41, EN60034-18-41	X	X
IEC 60034-30-1, EN 60034-30-1		X
IEC 60034-30-2, EN 60034-30-2	X	X
IEC 60072		X
EN 50347		X
NEMA MG1	X	X
UL 1004-1	X	X
UL 1004-6	X	
ABNT NBR 17094-1	X	X
CSA-C22.2 No. 100	X	X

Tolerances

Hollow Shafts

- ▶ Tolerance of the hollow shafts - \emptyset (DIN 748) according to ISO H7
- ▶ Keys according to DIN 6885, sheet 1 and 3
- ▶ Hollow shafts with keyway DIN 6885, sheet 3

Customer Shafts

- ▶ Tolerance of the customer's shaft journal according to ISO h6
- ▶ Tolerance of the customer's shaft journal for shrink discs according to ISO h6 or f6
- ▶ Keys according to DIN 6885 hollow shafts with keyway DIN 6885, page 3

Flanges

- ▶ Tolerance of the hole circle - \emptyset (DIN 42948)
- ▶ Flange centering tolerance
 - - \emptyset (DIN42948)
 - $\leq \emptyset$ 230 mm according to ISO j6
 - $> \emptyset$ 230 mm according to ISO h6









Präfix of NORD products

Product Type				
Torque Class NORD DuoDrive: 80 = 80 Nm 200 = 200 Nm				
Power Class Motor: 1 - 4				
Options				
SK	EVO	80	-1	...

Type Designation

The following figure shows an exemplary nameplate of NORD DuoDrive.

Nameplate

												08514180	
SK EVO 80-3 AZ BRE TF MS21 IG6													
M2 48,10 Nm			n2 208 r/min		i 10,08		fB 2,50				8 kg		
M1			 CLP HC 220								0,850 l		
3 ~ Mot.			S1		Th. Cl.130 (B)			IEC 60034					
326 VY		140 Hz		2100 r/min		2,14 A		Ur 400-460 V					
IE 5		EFF _{mot} 93,6%		I _{max} 6,42 A		1,05 kW		1,40 hp					
K _E 144 mV/min		K _T 2,24 Nm/A		ϑ 11°		SF 1,0		I _{sf} A					
R _{STR} 2,75 Ω		L _d 27,3 mH		L _q 40,9 mH		VPWM		CT					
IP 66		Brake 5 Nm								205 VDC			
123456789-1000				730		123456789		2021					
Getriebbau NORD GmbH & Co. KG, 22939 Bargteheide / GERMANY										www.nord.com			

Drive informations

Mounting

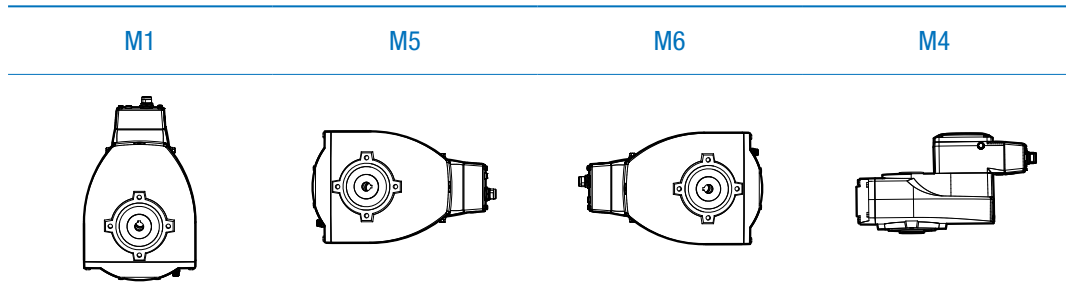

Position of electrical connection,

Cable Entry Position

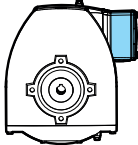
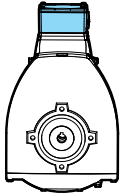
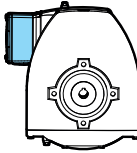
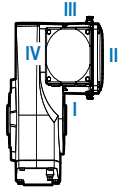
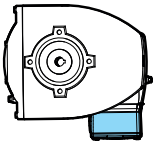
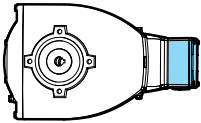
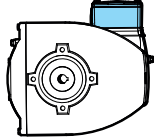
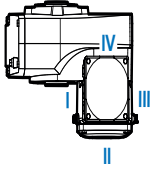
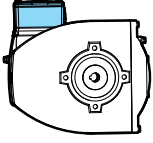
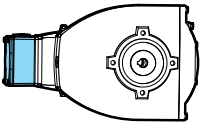
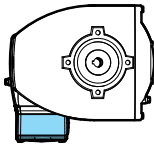
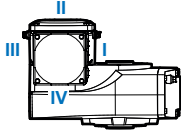
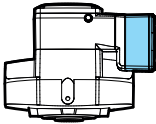
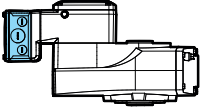
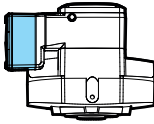
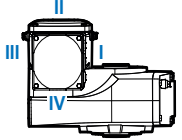
Mounting	Position of electrical connection			Cable Entry Position
	1	2	3	
M1				
M5				
M6				
M4				

Cable Entry

Type	Cable Entry
SK EVO 80	1 x M25 x 1,5 2 x M16 x 1,5
SK EVO 200	1 x M25 x 1,5 2 x M16 x 1,5

When selecting the mounting position, some restrictions must be observed:



Restrictions

Type	Ratio	M1, M5, M6	M4
SK EVO 80	3,24	ok	Not available
	6,86	ok	ok
	10,08	ok	ok
	13,3	ok	ok
	16,2	ok	ok
SK EVO 200	3,72	Only painted	Not available
	5,67	Only painted	Not available
	8,64	ok	Only painted
	11,45	ok	Only painted
	14,9	ok	ok
	18,1	ok	ok

Painting is recommended, particularly in the case of higher ambient temperatures of up to 40°C / 100°F and when selecting the drive unit with a brake and/or double shaft sealing rings.

Note

Drive informations

Operation Modes

Compared to asynchronous motors, the operation of synchronous motors has the following relevant differences:

- ▶ **No mains operation**

NORD DuoDrive and synchronous motors can only be operated on the converter..

- ▶ **Field weakening area**

NORD DuoDrive and synchronous motors cannot be operated or can only be operated to a very limited extent in the field weakening range.

The permanent magnets in the rotor induce a voltage in the stator during rotation. The induced voltage is proportional to the motor speed and reduces the current-driving clamping voltage. This reduces the available motor torque. In addition, there is a risk, e.g. in the event of falling loads of a hoist, that high induced voltages will damage the converter due to high motor speeds.

- ▶ **Inverter functions**

Certain converter functions such as DC braking are not available.

Operation on the NORD frequency converter

NORD DuoDrive and synchronous motors can be operated with all frequency converters of the following series.

- ▶ NORDAC *ON+*
- ▶ NORDAC *FLEX*
- ▶ NORDAC *LINK*
- ▶ NORDAC *PRO*

Some restrictions or boundary conditions must be observed.

Sizing

The power of the frequency converter may not exceed one power level greater than the nominal motor power.

Control Types

- closed-loop operation

Closed-loop operation is possible with all NORD frequency converters. When configuring/assigning, observe the correct choice of encoder and the appropriate frequency converter encoder interface.

- open-loop operation

Open-loop operation is possible with all NORD frequency converters from the following firmware versions.

NORDAC	Devices	Open Loop Firmware
NORDAC	<i>ON+</i>	1.2R5
NORDAC	<i>FLEX</i>	2.3R0
NORDAC	<i>LINK</i>	1.4R0
NORDAC	<i>PRO</i>	
	SK5xxE	3.3R0
	SK54xE	2.5R0
	SK5xxP	1.3R3

Furthermore, the following boundary conditions apply to open-loop operation:

- ▶ The used motor torque shall not exceed the nominal torque of the motor at any time.
- ▶ A ramp time of 0.6 seconds must not be undercut during acceleration or deceleration operations.

$$M_M \leq M_N$$

Ramp-up-time

Overview of cooling types EN 60034-6 for NORD DuoDrive

Designation		English short form
IC410	ohne Lüfter	TENV

Protection against touching moving and live parts as well as against the ingress of solid foreign bodies, dust and water.

The degree of protection is indicated by the letters IP (International Protection) and two codes. (e.B. IP55).

Protection Classes
according to DIN
EN 60034-5

Reference number 1	Abstract	Explanation
5	Protection against contact, foreign objects, dust	Complete contact protection, dust cannot penetrate in harmful amount.
6	Protection against contact, foreign objects, dust	Complete contact protection. Dust cannot penetrate.
Reference number 2	Abstract	Explanation
5	Protection against water	Protection against water jets from all directions. Water cannot penetrate in harmful quantities.
6	Protection against water	Protection against heavy seas and strong water jets from all directions. Water cannot penetrate in harmful quantities.

NORD DuoDrive complies with protection class IP55 as standard.

NORD DuoDrive can optionally be supplied with protection class IP66. The IP66 protection class is suitable for wet, high-pressure washed and dusty environments.

NORD DuoDrive is optionally available with protection class IP69K in the version with the gearbox cover in a hygienic design (HYGA).

NORD DuoDrive

Drive informations

Enveloping surface sound pressure, Sound pressure level L_{pA}

Meas. surf. dimension L_s Sound power level L_{WA}

Reference values on request

Noise Emission

The sound pressure level L_{pA} [dB(A)] of a geared motor under load is determined in an anechoic room of accuracy class 1 according to DIN EN ISO 3745 using the enveloping surface sound pressure method for a reference cuboid according to DIN EN ISO 3744. The reference cuboid enveloping the drive unit follows at a distance of $d = 1$ m the measuring surface on which the sound pressure levels are measured.

The measuring surface dimension L_s results from the measuring surface of the sound pressure level measurement. The sound power level L_{WA} is determined by adding the measured sound pressure level and the measurement area.

Information on the sound pressure level- and sound power level is always given with an accuracy of +3 dB(A) to consider possible scattering of the drives.

The existing sound pressure and sound power levels depend on

- ▶ the actual performance of the drive unit in operation
- ▶ the configuration of the drive unit (e.g. ratio)
- ▶ the customer's connection and environment of the drive unit

Due to the converter operation, there may be a slightly increased sound pressure level and sound power level due to magnetic buzzing or whistling. On request, Getriebebau NORD can provide calculated reference values for sound pressure level and sound power level.

The sound pressure level & sound power level listed in the following table serve to illustrate the sound pressure level- and sound power level to be expected for the power ratings of the drives and do not represent a guaranteed property for a specific drive unit of the customer.

Type	$n_1 = 2100 \text{ min}^{-1}$		$n_1 = 3000 \text{ min}^{-1}$	
	L_{pA}	L_{WA}	L_{pA}	L_{WA}
SK EVO 80	60 +3 dB(A)	72 +3 dB(A)	64 +3 dB(A)	76 +3 dB(A)
SK EVO 200	58 +3 dB(A)	71 +3 dB(A)	61 +3 dB(A)	73 +3 dB(A)

Surface Temperature

The highest surface temperatures are present at the side of the drive unit's motor. The following table lists the surface temperatures to be expected for the drive unit.

The data relates to the drive unit in the version without brake and without double radial shaft seals.

The actually present surface temperature depends on the customer's operating conditions (e.g. load behaviour or environmental conditions) and the specific configuration of the drive unit (e.g. speed ratio, without/with painting or mounting position).

Type	Surface θ [°C] (@θ environment = 20 °C)
SK EVO 80-1	46 °C
SK EVO 80-2	50 °C
SK EVO 80-3	55 °C
SK EVO 200-1	56 °C
SK EVO 200-2	64 °C
SK EVO 200-3	68 °C
SK EVO 200-4	81 °C

Special environmental conditions

SK EVO 200

The windings of NORD DuoDrive SK EVO 200 are designed with insulation class 130 (B). With ambient air temperatures of up to 40°C and installation altitudes of up to 1000 m, the maximum permissible temperature increase is 90 K.

The highest permissible winding temperature is 130° C. The integrated temperature protection is sized accordingly.

Heat class 130 (B)

SK EVO 80

The windings of NORD DuoDrive SK EVO 80 are designed with insulation class 130 (B). With ambient air temperatures of up to 40°C and installation altitudes of up to 1000 m, the maximum permissible temperature increase is 65 K.

The highest permissible winding temperature is 105° C. The integrated temperature protection is sized accordingly.

Heat class 105 (A)

At ambient temperatures of < -20°C or > 40°C, technical modifications to the DuoDrive unit may be necessary. The type of modification is chosen according to the application.

Ambient
temperature
< -20°C oder > 40°C

Drive informations





Certifications and Approvals

NORD DuoDrive may be used in every country globally.

Local laws, regulations and individual requirements for market access may be considered.

NORD provides an overview of the global regulations on: <https://info.nord.com/efficiency-regulations-motors>

NORD DuoDrive comply with or are certified:

Europe (EU), Switzerland, Turkey	CE	
United Kingdom	UKCA	
Eurasian Economic Union	EAC	
USA	UL	
Canada	CSA	

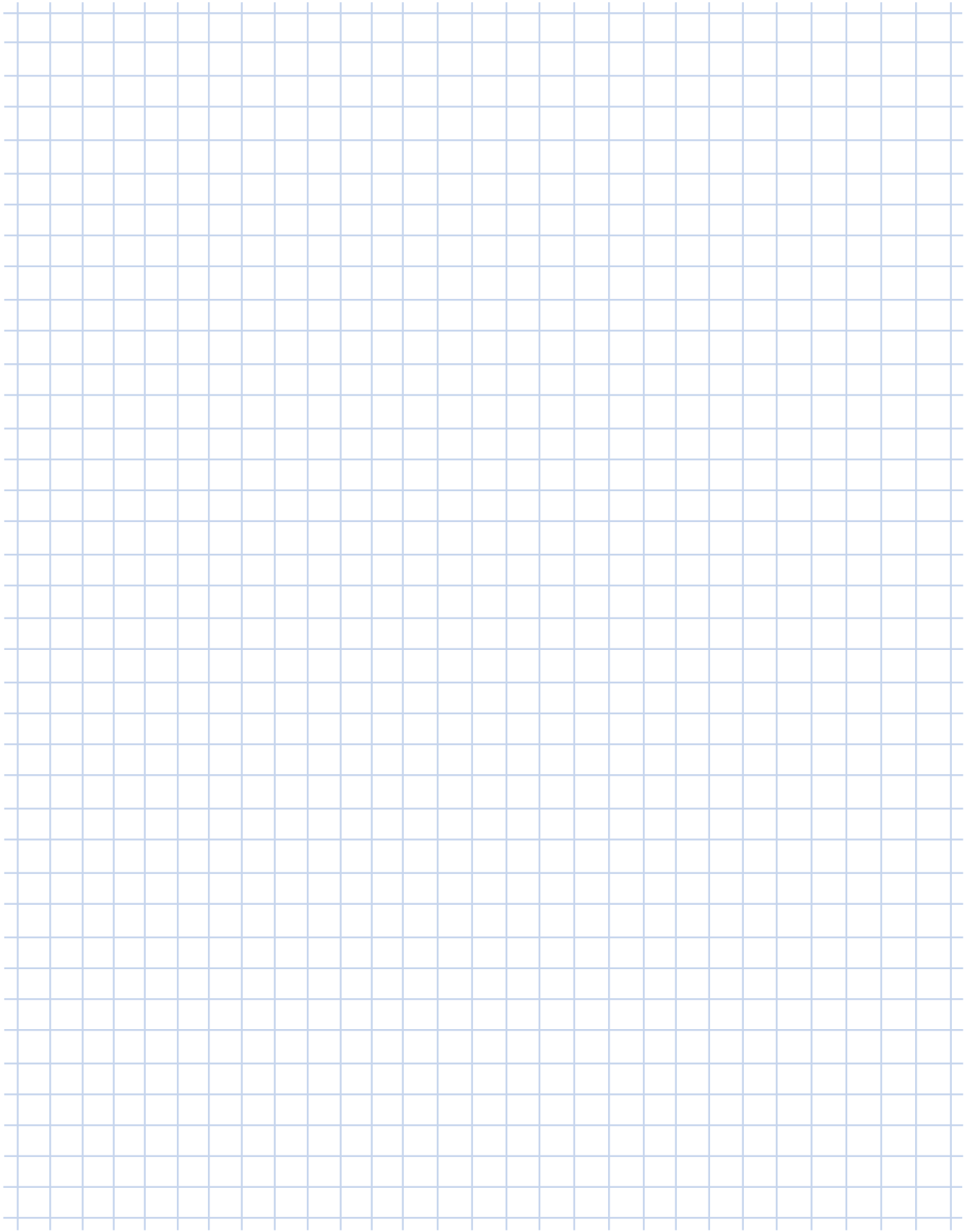
A large grid area for taking notes, consisting of a 20x30 grid of light blue lines.

Gear-Options

Available gear unit options for the NORD DuoDrive series

Key	Description
AF	Hollow Shaft, Flange B5
AZ	Hollow Shaft, Flange B14
B	Fixing Element for Hollow Shaft
D	Torque Arm
FKM	Output Shaft Seals FKM (Viton)
H / SH	Protection Cover for Hollow Shaft and Shrink Disc
H66	Protection Cover for Hollow Shaft IP66
HYGA	Gear Cover in Hygienic Design
M	GRIPMAXX
S	Shrink Disc
VF	Solid Shaft , Flange B5
VL	Reinforced Output Shaft Bearings
VZ	Solid Shaft , Flange B14
2WD	Double Output Shaft Seals

Shaft Design

Hollow shaft (A)

Standard hollow shafts with parallel keys are made from C45. Many NORD geared motors are available with various shaft diameters.

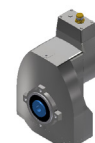

Fixing element (B)

As small vibrations occur with all shafts, NORD supplies an optional fastening kit. This prevents the geared motor from changing its position in an axial direction. The fastening kit can be mounted in two different ways.

1	2	3	4	11	
d x mH	a	D		L	
20 x 135	9,6	30	M6 x 30	A6	111
25 x 135	19,0	35	M10 x 45	A10	109
30 x 135	19,0	40	M10 x 45	A10	109
35 x 135	23,5	45	M12 x 55	A12	105
40 x 135	24,5	55	M16 x 70	A16	104

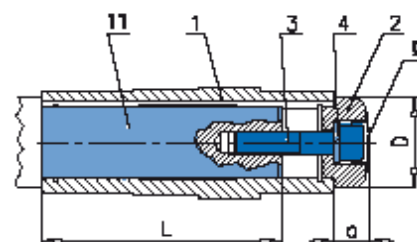

Solid shaft (V)

NORD standard shafts with parallel keys have a threaded hole in the face side. The shafts are available in metric dimensions and in inch dimensions on request. The standard material is C45.

Housing Design

B14 flange (Z)

The NORD B14 flange has threaded holes and a centered mating surface in the housing of the geared motor. Usually, this is used to attach the geared motor to the base of the application or to attach a wide range of add-on components, such as a B5 flange, torque arm or shaft cover. As standard, the B14 flange has metric dimensions and is a compact method of attaching NORD DuoDrive.



B5 flange (F)

A B5 flange is a simple mounting flange with a large diameter, through holes and a centered mating surface, with which the gear unit can be securely attached to the application. The B5 flange has metric dimensions as standard.

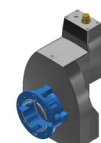

Hygienic-friendly gearbox cover (HYGA)

The hygienic cover is held via a central screw that is in an aluminum bridge that is screwed within the gear unit housing. The central screw is countersunk in the cover; the screw head is covered by a sealing cap.

Gear-Options

Torque Transmission Options

Shrink disc (S)

The shrink disc is based on a tried-and-tested clamping principle and enables torque transfer by friction, by converting the tightening force of the clamping screws into a radial pressure between the shaft and the hub, which results in shrinking onto the customer's shaft. Shrink discs enable a force fit which is completely free of play, and which can transfer large torques, in contrast with other types of mounting. Shrink discs do not wear, even with frequent changes of load or direction of rotation.

- Advantages

Shrink discs provide the following advantages:

- ▶ no corrosion of the mating surface
- ▶ easy assembly and dismantling
- ▶ often larger hole diameters are possible than for hollow shafts with parallel keys

Type	Ø Hollow shaft		Shrink disk				Hex bolt DIN 933 10.9 Vz		
	mm	inch	Type	M _{2max} [Nm]	S ^{h6}	S ^{f6}	d x l	Z _s	M _A [Nm]
SK EVO 80	25	1.0000	SN 25 / 34 V	120	3.10	2.50	M5 x 25	6	7
	30	1.1250	SN 30 / 40 V		8.20	7.20	M6 x 35	8	12
	30	1.1875	SN 30 / 40 V		8.20	7.20	M6 x 35	8	12
	30	1.2500	SN 30 / 40 V		7.70	6.40	M6 x 35	8	12
	35	1.4375	SN 35 / 46 V		11.90	10.40	M6 x 35	10	12
	40	1.5000	SN 35 / 49 V		13.40	11.40	M6 x 35	10	12
SK EVO 200	25	1.0000		250	1.50	1.20	M5 x 25	6	7
	30	1.1250	SN 30 / 40 V		3.90	3.40	M6 x 35	8	12
	30	1.1875	SN 30 / 40 V		3.90	3.40	M6 x 35	8	12
	30	1.2500	SN 30 / 40 V		3.70	3.10	M6 x 35	8	12
	35	1.4375	SN 35 / 46 V		5.70	5.00	M6 x 35	10	12
	40	1.5000	SN 35 / 49 V		6.40	5.50	M6 x 35	10	12

The GRIPMAXX is an innovative keyless bushing system designed and developed using the latest in Finite Element Modeling technology (FEM).

The GRIPMAXX is an innovative keyless bushing system designed and developed using the latest in Finite Element Modeling technology (FEM). GRIPMAXX uses the proven NORD Shrink Disc system and a unique hollow shaft design which provides both high strength and the required elasticity needed to accommodate many inch and metric bushing inserts. Like the shrink disc, GRIPMAXX results in a high-capacity interference fit.

GRIPMAXX (M)
- Bushing system

- High strength

Type	Ø Bushing		Shrink disk			Hex bolt DIN 933 10.9 Vz		
	mm	inch	Type	M _{2max} [Nm]	S ^{h11}	d x l	Z _s	M _A [Nm]
SK EVO 80	30	1.1250	SN 35 / 49 V	120	7.60	M6 x 35	10	12
	30	1.1875			8.40			
	30	1.2500			9.40			
	35	1.3750			11.50			
	35	1.4375			12.50			
	40	1.5000			15.00			
SK EVO 200	30	1.1250	SN 35 / 49 V	250	3.60	M6 x 35	10	12
	30	1.1875			4.00			
	30	1.2500			4.50			
	35	1.3750			5.50			
	35	1.4375			6.00			
	40	1.5000			7.20			

Gear-Options

Shaft cover options



Hollow shaft cover (H)

An optional cover for the rotating hollow shaft is available. This also protects the output shaft against dust and dirt.

Shrink disk cover (SH)

A shrink disc cover is required for all shrink disk gear units and provides protection from the rotating shrink disk.

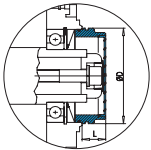

IP66 Hollow shaft cover (H66)

NORD supplies hollow shaft covers in protection class IP66 (protection against dust and splashed water). The rotating hollow shaft is completely sealed against humidity and dust.

Bearing design

Reinforced output bearings (VL)

The use of reinforced output bearings with increased load bearing capacity enables higher external loads (radial/axial) to be absorbed. Please consult NORD in case of predominantly greater axial loads.

Mounting Options

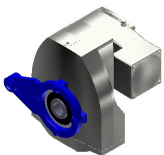

Torque arm (D)

A torque arm is a compact, simple solution to secure a geared motor with a hollow shaft. It is bolted to the B14 flange of the geared motor. The torque arm has a rubber bushing on the attachment hole which absorbs the load impulses.

Sealing Options

FKM - Fluoro-rubber
Viton - Trade name
- 35 bis 200°C

FKM Oil seals (VI)

The NORD standard oil seals are made of Nitrile or rubber and are rated for temperatures up to 125°C or 250°F. If ambient or oil temperatures rise above this level NORD recommends using fluoro-rubber (also called FKM) oil seals. FKM seals are rated from -35°C to 200°C (-30°F to 400°F).

Double-Output shaft seals (2WD)

Increased reliability is provided by the double shaft seal on the output side. It consists of two shaft sealing rings. Substances acting on the seal from the outside must overcome additional barriers before they can reach the inner sealing lip that seals the oil space and cause leakage.

In the event of damage from the outside, the second shaft seal provides additional leakage safety. The double shaft seal has an inner shaft seal (shape A, without protective lip) and an outer shaft seal (shape AS, with protective lip).

Pressure vent / Autovent™ (DR)

The AUTOVENT™ helps prevent bearing and gear damage by behaving like a check valve to block the entry of foreign material and prevent lubrication contamination from dust particles, moisture, and air-borne process chemicals. The breather opens if the internal pressure rises during operation and closes tightly as the gearbox cools. This option is perfect for humid conditions and wash-down environments, helping to maintain proper oil cleanliness, while reducing foaming and oxidation.

The position of the Spring-loaded breather / Autovent™ depends on the mounting position of NORD DuoDrive and the position of the terminal box and cable entry location or the position of the power connector.

Position Pressure vent / Autovent™

Position of electrical connection: 1

M5

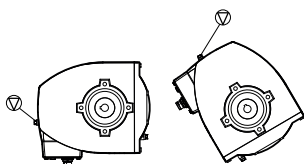

M1

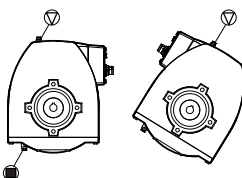

M6

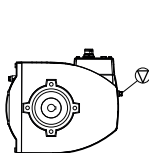

M4

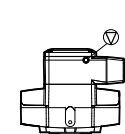

Pressure vent / Autovent™



Oil drain

Position of electrical connection: 2

M5

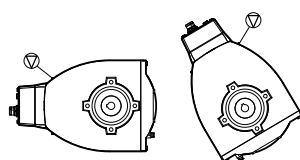

M1

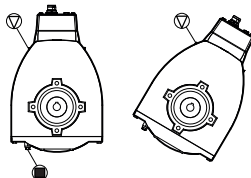

M6

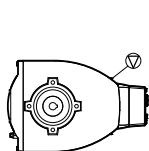

M4

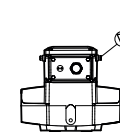

Position of electrical connection: 3

M5

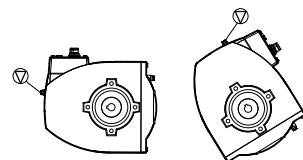

M1

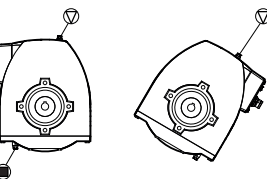

M6

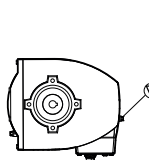

M4

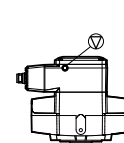

Motor-Options

Available motor options from the NORD DuoDrive series

Key	Description
TF	Temperature sensors, PTCs
BRE	Holding
MS	Motor connector design MS31, MS32, MS21, MSR, MSR VA
IGxxP	IG6P5, IG61P8, IG62P5, IG62P8 Incremental encoder with plug 5- or 8-pin
MGZ	Magnetic encoder with zero track
MGZN	Magnetic encoder with zero track and plug 5-pin

Thermal Motor Protection (TF)

A sensible motor selection protects the motor from overheating due to the application or the ambient conditions. Factors that can lead to overheating of the motor are e.g

- ▶ Overload
- ▶ high ambient temperatures
- ▶ a limited cooling air supply
- ▶ low motor speed because of inverter operation

NORD DuoDrive are equipped with thermal motor protection.

- ▶ TF = PTC thermistor

These are used for the direct monitoring of the winding temperatures when the motor power is fully utilized.

3 TF temperature sensors (one per strand) connected in series are located at the warmest points of the windings. Their connections are guided to 2 terminals in the terminal box.

When the nominal response temperature (NAT) is reached, the temperature sensor increases its resistance value by leaps and bounds to almost 10 times.

- ▶ EVO 200: 130° C Spannung max. 30 V Klemmen TP1 + TP2
- ▶ EVO 80: 110° C Spannung max. 30 V Klemmen TP1 + TP2

The PTC temperature sensor fulfils its protective function only connected to a tripping device! A tripping device evaluates the increase in resistance and switches off the drive.

Response temperature

Encoders

Incremental Encoders (IG / MG)

Modern drive applications often require speed feedback. For this purpose, incremental encoders are usually used, which convert the rotational movement into electrical signals as measured value transducers.

These signals are read and processed by frequency converters or other control devices. The incremental encoder of NORD DuoDrive works according to a magnetic principle. The encoder consists of two components, the magnetic wheel, which sits on the motor shaft and the sensor board.

The integrated electronics convert the measurement signals into a digitized rectangular signal according to TTL or HTL logic.

In combination with NORD frequency converters, the following requirements can be met:

- ▶ Speed control with large adjustment range
- ▶ high speed accuracy, load-independent
- ▶ Synchronization controls
- ▶ Positioning controls
- ▶ Standstill torques
- ▶ high overload reserves

Type	Version	Supply voltage	Resolution	Connection
IG6P5	RS485	10...30 V DC	Digital output of position and speed	M12 / 5-pole
IG61P8	TTL	10...30 V DC	2048 ppr	M12 / 8-pole
IG62P5	HTL	10...30 V DC	2048 ppr	M12 / 5-pole
IG62P8	HTL	10...30 V DC	2048 ppr	M12 / 8-pole
MGZ	HTL	8...35 V DC	1024 ppr	Cable
MGZN	HTL	8...35 V DC	1024 ppr	M12 / 5-pole

Motor-Options

Attachment of Incremental Encoders Type IG

completely protects

The incremental encoder is fully integrated into the motor housing and is possible with all variants of NORD DuoDrive.

The motor-integrated installation completely protects the encoder system from external influences.

Connection
IG

The electrical connection is made via a flange plug in the terminal box of NORD DuoDrive. Depending on the encoder variant, plugs with 5 connections or 8 connections are available. The appropriate signal cable can be supplied on request.

Signal	IG6P5		IG62P5		IG61P8, IG62P8	
	Pin	Colour Stranding	Pin	Colour Stranding	Pin	Colour Stranding
0V	3	blue	3	blue	1	white
+V	1	brown	1	brown	2	brown
A+			4	black	3	green
A\					4	yellow
B+			2	white	5	grey
B\					6	pink
N+			5	grey	7	blue
N\					8	red
RS485A	2	white				
RS485B	4	black				

Attachment of Incremental Encoders Type MGZ

The magnetic screw is located under the cover of the motor, while the sensor is screwed against it from the outside.

Connection
MGZ / MGZN

Signal	MGZN	
	Pin	Colour Stranding
GND	1	black
U _b	2	red
Channel A	3	brown
Channel B	4	orange
Channel C	5	green

NORD DuoDrive can also be supplied with power connectors. The following connectors are available as standard:

- ▶ Motor plug MS21 (HAN Q8)
- ▶ Motor plug MS31 / MS32 (HAN 10E)
- ▶ Motor plug MSR / MSR VA

The connectors are delivered without a mating plug and protected against dirt with a protective cap. The matching mating plugs are also available on request.

Motor connectors (MS)

Motor Connector MS21

Plug: HAN Q8
 Number of contacts: 8 - polig
 Current: 16 A max.
 Voltage: 500 V max. (600 V max. gemäß UL/CSA)
 Cage tension spring connection

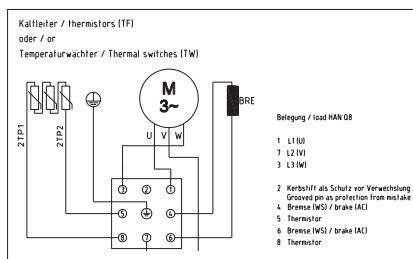

Motor Connector MS31 / 32 / 31E / 32E

Plug: HAN 10 ES/HAN ESS
 Number of contacts: 10-polig
 Current: 16 A max.
 Voltage: 500 V max.
 (600 V max. gemäß UL/CSA)
 Cage tension spring connection

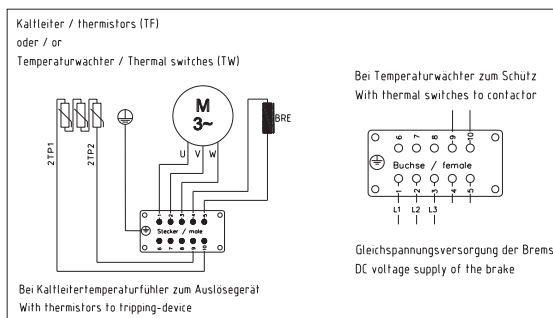

The MS31E and MS32E connectors are each suitable for applications with increased electromagnetic compatibility (EMC protection).

with EMV-Protection

Motor Connector MSR / MSR VA

Plug: M20 x 1,5 Motor-Einschraubgewinde mit M25 x 1,5 Verbindungsgewinde
 Number of contacts: 8-polig (4 + 3+ PE)
 Current: 28 A max.
 Voltage: 600 V max.

Optionally available in stainless steel (VA) version.

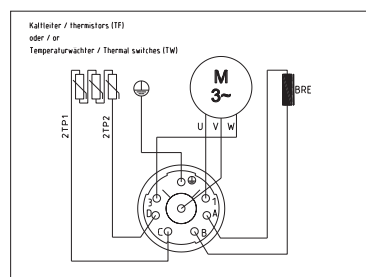

VA-Version

Motor-Options

Brake (BRE)

The DuoDrive optionally offers an integrated holding brake with an emergency stop function.

Assignment

DuoDrive	BRE 2,5 [Nm]	BRE 5 [Nm]	BRE 7,5 [Nm]	BRE 10 [Nm]	BRE 20 [Nm]
SK EVO 80-1	X	*			
SK EVO 80-2		X			
SK EVO 80-3		X			
SK EVO 200-1		X		*	*
SK EVO 200-2				X	*
SK EVO 200-3				X	*
SK EVO 200-4					X
Weight [kg]	2	2	2	3,5	3,5
J [10-3 kgm ²]	0,015	0,015	0,015	0,045	0,173

* alternatively possible

Characteristics of the brake

Property	Value	Remark
Maximum speed	6000 rpm	
Friction work per emergency stop	3000 J	then regeneration by simple braking
Switching frequency at 1500 J	100 Schaltungen/ h	then maximum friction is reduced
Protection	IP20	TENV version (brake is enclosed)
Control via PWM	possible	
Connection voltage	24VDC, 180VDC, 205VDC	

Control of the brake

To control the brakes, a converter with a corresponding rectifier is required.

A rectifier integrated in the terminal box is not available for the NORD DuoDrive. Alternatively, a rectifier can be used in the control cabinet.

With the SK EBGR-1, NORD offers a rectifier. Further technical information on the rectifier can be found on the NORD homepage.

Rectifier
SK EBGR-1

Brake Selection

The selection of a standard combination motor-brake according to the above overview must be ensured by careful project planning! The braking torque must be determined according to the requirements of the application.

The design of the drives is based, among other things, on the torque requirement of the application as well as on the motor-side torque. If necessary, the braking torque must be significantly reduced so that the gearbox is not overloaded when braking large moving masses.

Braking torque
determine



Holding brake • Working brake • Emergency stop brake

A distinction between „holding brake“, „working brake“ and „emergency stop brake“ arises from the type of application.

A holding brake has the task of preventing a drive train from moving at a standstill or in an almost stationary state.

Holding brake

As soon as a brake must do significant friction work, it is considered a working brake. The respective friction as well as the switching frequency must be determined and taken into account when selecting the brake.

Working brake

For the emergency stop function of a brake, very large masses must be braked once, and the brake is loaded with correspondingly large energies.

Emergency stop brake

In this case, the brake must be selected according to the maximum permissible friction per braking.

Application-related examples

The acceleration and deceleration of the application is controlled by a frequency converter and only when the application comes to a standstill does the mechanical spring brake fall in.

The brake is therefore only used to „hold“ the application (parking position) and does not perform any friction work, consequently no conditioning of the friction surfaces. Friction work is only implemented in the event of an emergency stop or power failure.

Holding brake
- parking position

The gear motor is fed directly from the local power supply. To delay the application, the mechanical spring-loaded brake must apply a braking torque and thus performs friction work.

Working brake

The continuous friction work ensures conditioning of the friction pairings. Care must be taken to ensure that the resulting frictional heat is dissipated efficiently. The mechanical brake is also used to „hold“ the application (parking position).

- parking position

Performance data

P_1		n_1/n_2		M_2		f_B	i_{tot}	F_R/F_A				Model Type	$[kg]$	$[lb]$
$[kW]$	$[hp]$	$[r/min]$		$[Nm]$	$[lb-in]$			F_R	F_A	F_R	F_A			
								$[N]$	$[lb]$	$[N]$	$[lb]$			
0,35	0,46	2.100	130	25,8	228,3	4,3	16,2	4.010	902	8.160	1.836	SK EVO 80-1	18	39
		2.100	158	21,2	187,6	5,7	13,3	3.770	848	7.380	1.661			
		2.100	208	16,0	141,6	7,5	10,1	3.450	776	6.480	1.458			
		2.100	306	10,9	96,5	10,1	6,9	3.050	686	5.480	1.233			
		2.100	648	5,2	46,0	19,4	3,2	2.390	538	4.020	905			
0,50	0,67	3.000	185	25,8	228,3	4,3	16,2	3.550	799	6.750	1.519	SK EVO 80-1	18	39
		3.000	226	21,2	187,6	5,7	13,3	3.330	749	6.180	1.391			
		3.000	298	16,0	141,6	7,5	10,1	3.060	689	5.490	1.235			
		3.000	437	10,9	96,5	10,1	6,9	2.700	608	4.690	1.055			
		3.000	926	5,2	46,0	19,4	3,2	2.120	477	3.370	758			
0,70	0,95	2.100	130	51,6	456,7	2,1	16,2	3.880	873	7.820	1.760	SK EVO 80-2	18	40
		2.100	158	42,3	374,4	2,8	13,3	3.660	824	7.120	1.602			
		2.100	208	32,1	284,1	3,7	10,1	3.370	758	6.290	1.415			
		2.100	306	21,8	192,9	5,0	6,9	2.990	673	5.350	1.204			
		2.100	648	10,3	91,2	9,7	3,2	2.360	531	3.950	889			
1,00	1,34	3.000	185	51,6	456,7	2,1	16,2	3.410	767	6.450	1.451	SK EVO 80-2	18	40
		3.000	226	42,3	374,4	2,8	13,3	3.220	725	5.950	1.339			
		3.000	298	32,1	284,1	3,7	10,1	2.970	668	5.320	1.197			
		3.000	437	21,8	192,9	5,0	6,9	2.650	596	4.580	1.031			
		3.000	926	10,3	91,2	9,7	3,2	2.090	470	3.310	745			
1,05	1,40	2.100	130	77,3	684,1	1,4	16,2	3.740	842	7.480	1.683	SK EVO 80-3	19	41
		2.100	158	63,5	562,0	1,9	13,3	3.550	799	6.860	1.544			
		2.100	208	48,1	425,7	2,5	10,1	3.280	738	6.110	1.375			
		2.100	306	32,8	290,3	3,4	6,9	2.940	662	5.230	1.177			
		2.100	648	15,5	137,2	6,5	3,2	2.330	524	3.880	873			
1,50	2,00	3.000	185	77,3	684,1	1,4	16,2	3.280	738	6.160	1.386	SK EVO 80-3	19	41
		3.000	226	63,5	562,0	1,9	13,3	3.110	700	5.710	1.285			
		3.000	298	48,1	425,7	2,5	10,1	2.890	650	5.150	1.159			
		3.000	437	32,8	290,3	3,4	6,9	2.590	583	4.460	1.004			
		3.000	926	15,5	137,2	6,5	3,2	2.060	464	3.250	731			

P_1		n_1/n_2		M_2		f_B	i_{tot}	F_R/F_A				Model Type		
[kW]	[hp]	[rpm]	[rpm]	[Nm]	[lb-in]			F_R	F_A	F_R	F_A		[kg]	[lb]
1,10	1,50	2.100	116	90,5	800,9	2,4	18,1	3.870	871	7.920	1.782	SK EVO 200-1	33	72
		2.100	141	74,5	659,3	3,4	14,9	3.670	826	7.250	1.631			
		2.100	183	57,3	507,1	4,4	11,5	3.420	770	6.470	1.456			
		2.100	243	43,2	382,3	5,6	8,6	3.150	709	5.760	1.296			
		2.100	371	28,3	250,5	7,8	5,7	2.780	626	4.870	1.096			
		2.100	564	18,6	164,6	10,2	3,7	2.440	549	4.140	932			
1,50	2,00	3.000	166	86,4	764,6	2,5	18,1	3.410	767	6.510	1.465	SK EVO 200-1	33	72
		3.000	201	71,1	629,2	3,5	14,9	3.240	729	6.030	1.357			
		3.000	262	54,7	484,1	4,6	11,5	3.010	677	5.450	1.226			
		3.000	347	41,2	364,6	5,8	8,6	2.780	626	4.900	1.103			
		3.000	529	27,1	239,8	8,1	5,7	2.460	554	4.180	941			
		3.000	806	17,8	157,5	10,7	3,7	2.160	486	3.480	783			
1,50	2,00	2.100	116	123,0	1.088,6	1,8	18,1	3.710	835	7.520	1.692	SK EVO 200-2	33	72
		2.100	141	102,0	902,7	2,5	14,9	3.540	797	6.940	1.562			
		2.100	183	78,1	691,2	3,2	11,5	3.310	745	6.250	1.406			
		2.100	243	58,9	521,3	4,1	8,6	3.070	691	5.590	1.258			
		2.100	371	38,7	342,5	5,7	5,7	2.730	614	4.770	1.073			
		2.100	564	25,4	224,8	7,5	3,7	2.410	542	4.080	918			
2,20	3,00	3.000	166	127,0	1.124,0	1,7	18,1	3.210	722	6.090	1.370	SK EVO 200-2	33	72
		3.000	201	104,0	920,4	2,4	14,9	3.080	693	5.700	1.283			
		3.000	262	80,2	709,8	3,1	11,5	2.890	650	5.200	1.170			
		3.000	347	60,5	535,4	4,0	8,6	2.690	605	4.710	1.060			
		3.000	529	39,7	351,3	5,5	5,7	2.390	538	4.060	914			
		3.000	806	26,1	231,0	7,3	3,7	2.120	477	3.390	763			
2,20	3,00	2.100	116	181,0	1.601,9	1,2	18,1	3.430	772	6.850	1.541	SK EVO 200-3	34	74
		2.100	141	149,0	1.318,7	1,7	14,9	3.310	745	6.420	1.445			
		2.100	183	115,0	1.017,8	2,2	11,5	3.140	707	5.870	1.321			
		2.100	243	86,4	764,6	2,8	8,6	2.940	662	5.320	1.197			
		2.100	371	56,7	501,8	3,9	5,7	2.630	592	4.590	1.033			
		2.100	564	37,3	330,1	5,1	3,7	2.340	527	3.950	889			
3,00	4,00	3.000	166	173,0	1.531,1	1,3	18,1	2.990	673	5.620	1.265	SK EVO 200-3	34	74
		3.000	201	142,0	1.256,7	1,8	14,9	2.890	650	5.320	1.197			
		3.000	262	109,0	964,7	2,3	11,5	2.750	619	4.920	1.107			
		3.000	347	82,5	730,1	2,9	8,6	2.580	581	4.500	1.013			
		3.000	529	54,1	478,8	4,1	5,7	2.320	522	3.930	884			
		3.000	806	35,6	315,1	5,3	3,7	2.070	466	3.290	740			
3,00	4,00	2.100	116	247,0	2.186,0	0,9	18,1	3.120	702	6.130	1.379	SK EVO 200-4	34	74
		2.100	141	203,0	1.796,6	1,2	14,9	3.050	686	5.840	1.314			
		2.100	183	156,0	1.380,6	1,6	11,5	2.940	662	5.440	1.224			
		2.100	243	118,0	1.044,3	2,0	8,6	2.780	626	5.000	1.125			
		2.100	371	77,3	684,1	2,8	5,7	2.530	569	4.390	988			
		2.100	564	50,8	449,6	3,7	3,7	2.270	511	3.790	853			

Motor data

Type	M_N	P_N	P_N	n_N	I	I_{max}	η	J	M_{max}	k_T	k_E
	[Nm]	[kW]	[hp]	[r/min]	400V [A]	400V [A]	[%]	[kgm ²]	[Nm]	[Nm/A]	[mV/r/min]
SK EVO 80-1	1,6	0,35	0,46	2.100	0,88	1,76	89,1	0,00019	3,2	1,82	139
SK EVO 80-1	1,6	0,5	0,65	3.000	1,25	2,5	90,6	0,00019	3,2	1,28	97
SK EVO 80-2	3,2	0,7	0,95	2.100	1,61	3,22	92,5	0,00038	6,4	1,99	139
SK EVO 80-2	3,2	1,0	1,35	3.000	2,3	4,60	93,3	0,00038	6,4	1,39	97
SK EVO 80-3	4,8	1,05	1,4	2.100	2,35	4,70	93,6	0,00057	9,6	2,04	140
SK EVO 80-3	4,8	1,5	2,0	3.000	3,38	6,76	94,3	0,00057	9,6	1,42	98
SK EVO 200-1	5,0	1,1	1,5	2.100	2,41	4,83	94,6	0,00090	10,0	2,07	140
SK EVO 200-1	4,8	1,5	2,0	3.000	3,36	6,72	95,0	0,00090	9,6	1,43	101
SK EVO 200-2	6,84	1,5	2,0	2.100	3,41	6,82	94,6	0,00110	13,68	2,01	142
SK EVO 200-2	7,0	2,2	3,0	3.000	5,00	10,0	95,0	0,00110	14,0	1,40	100
SK EVO 200-3	10,0	2,2	3,0	2.100	4,77	9,54	95,1	0,00176	20,0	2,10	144
SK EVO 200-3	9,55	3,0	4,0	3.000	6,55	13,1	93,9	0,00176	19,1	1,46	102
SK EVO 200-4	13,64	3,0	4,0	2.100	6,24	9,54	93,8	0,00176	20,0	2,19	144

Holding torque

Type	M_0/M_N
SK EVO 80	0,90
SK EVO 200-1	0,65
SK EVO 200-2	0,85
SK EVO 200-3	0,85
SK EVO 200-4	0,65

Moment of inertia

Type	$J_i = 3,24$ [kgm ²]	$J_i = 6,86$ [kgm ²]	$J_i = 10,08$ [kgm ²]	$J_i = 13,30$ [kgm ²]	$J_i = 16,20$ [kgm ²]
SK EVO 80-1	0,00153	0,00075	0,00053	0,00043	0,00039
SK EVO 80-2	0,00171	0,00092	0,00070	0,00060	0,00056
SK EVO 80-3	0,00188	0,00109	0,00088	0,00078	0,00073

Type	$J_i = 3,72$ [kgm ²]	$J_i = 5,67$ [kgm ²]	$J_i = 8,64$ [kgm ²]	$J_i = 11,45$ [kgm ²]	$J_i = 14,90$ [kgm ²]	$J_i = 18,10$ [kgm ²]
SK EVO 200-1	0,00351	0,00240	0,00163	0,00137	0,00120	0,00112
SK EVO 200-2	0,00370	0,00260	0,00182	0,00157	0,00140	0,00132
SK EVO 200-3	0,00428	0,00317	0,00240	0,00215	0,00197	0,00189
SK EVO 200-4	0,00428	0,00317	0,00240	0,00215	0,00197	0,00189

Deviations from these values can result from options such as brakes, encoders, shrink disks, GRIPMAXX™.

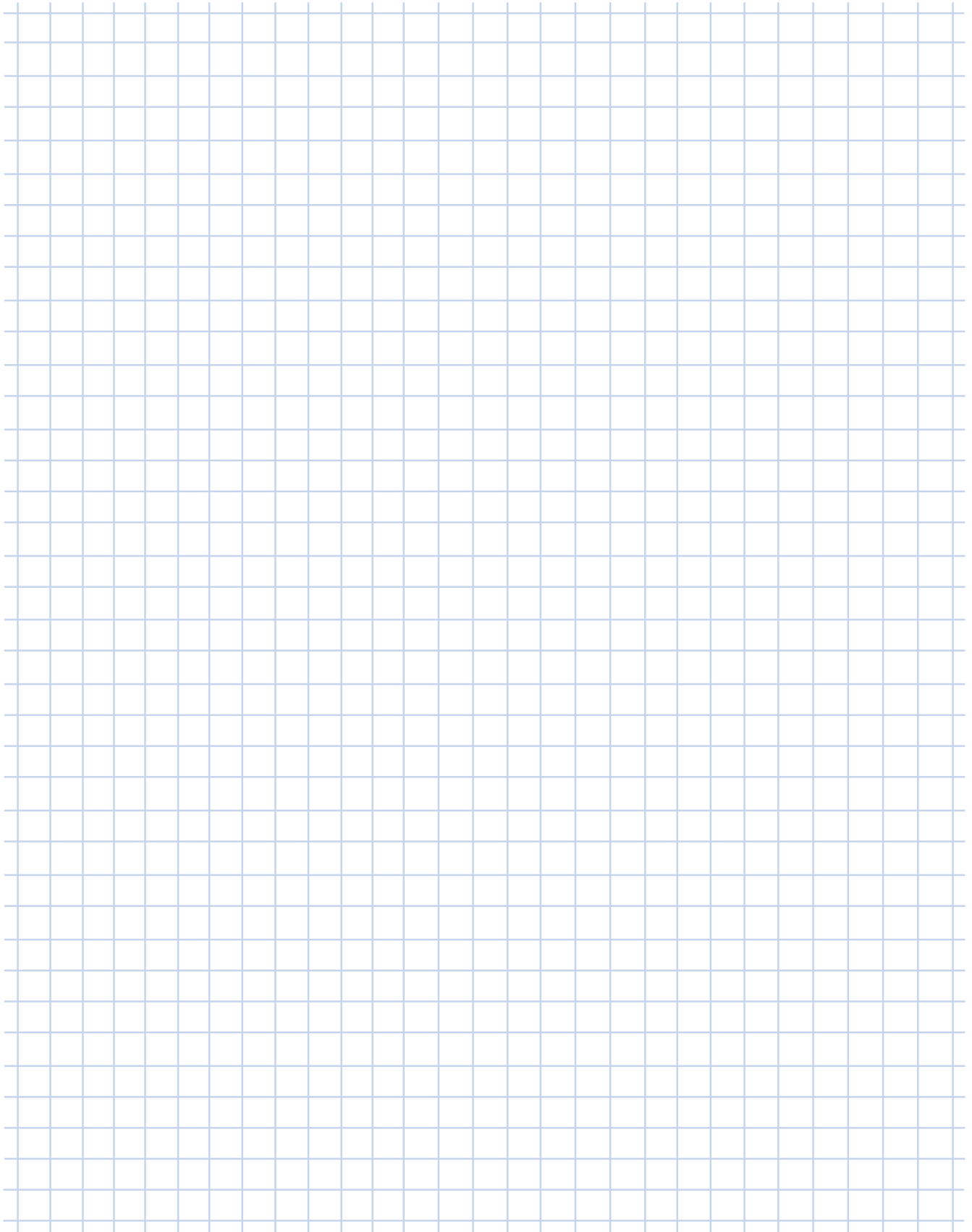

A large grid area for taking notes, consisting of a 20x20 grid of small squares. The grid is composed of light blue lines on a white background.

Motor characteristics

SK EVO 80-1 2.100 r/min

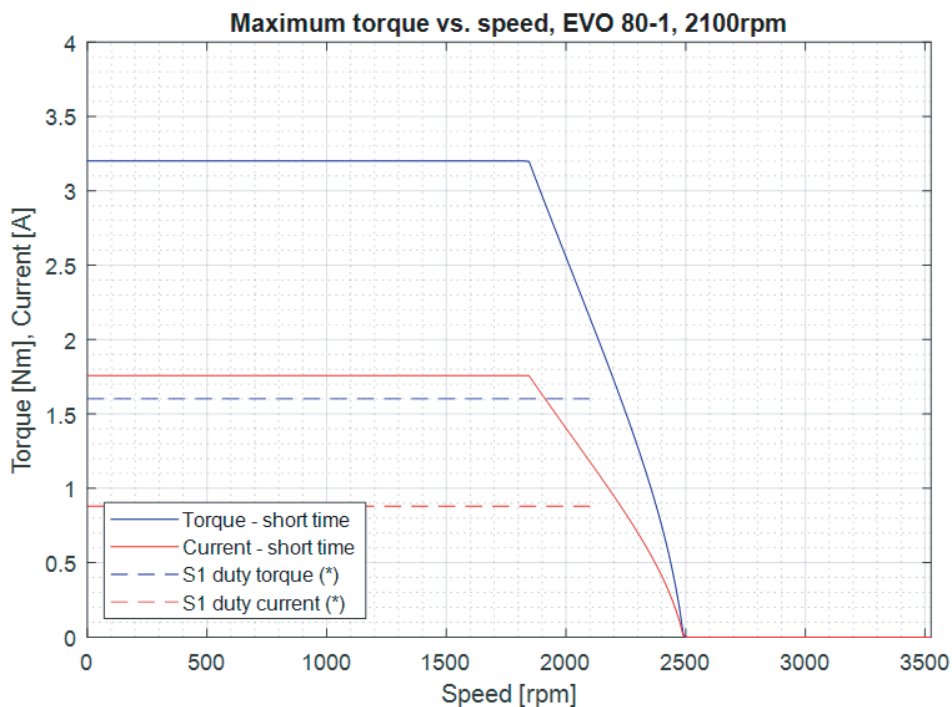

SK EVO 80-2 2.100 r/min

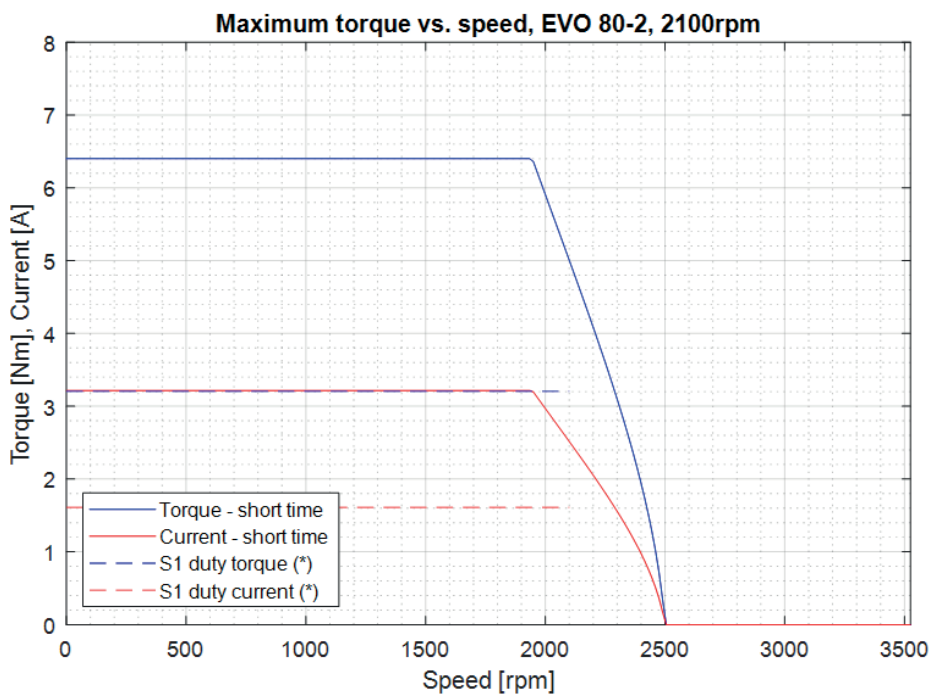

SK EVO 80-3 2.100 r/min

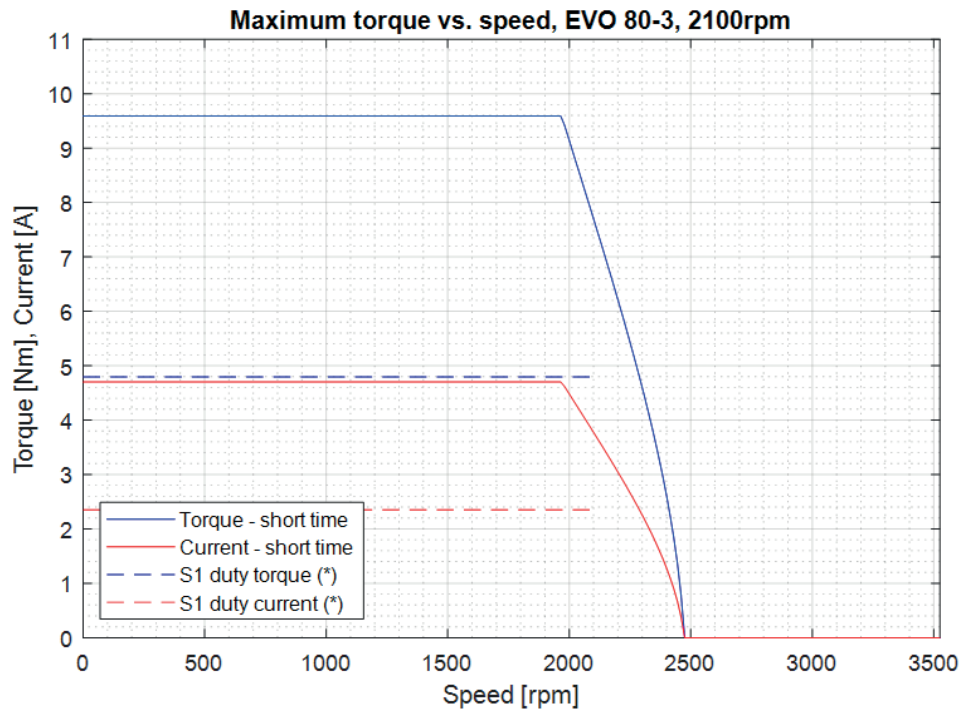

Motor characteristics

SK EVO 80-1 3.000 r/min

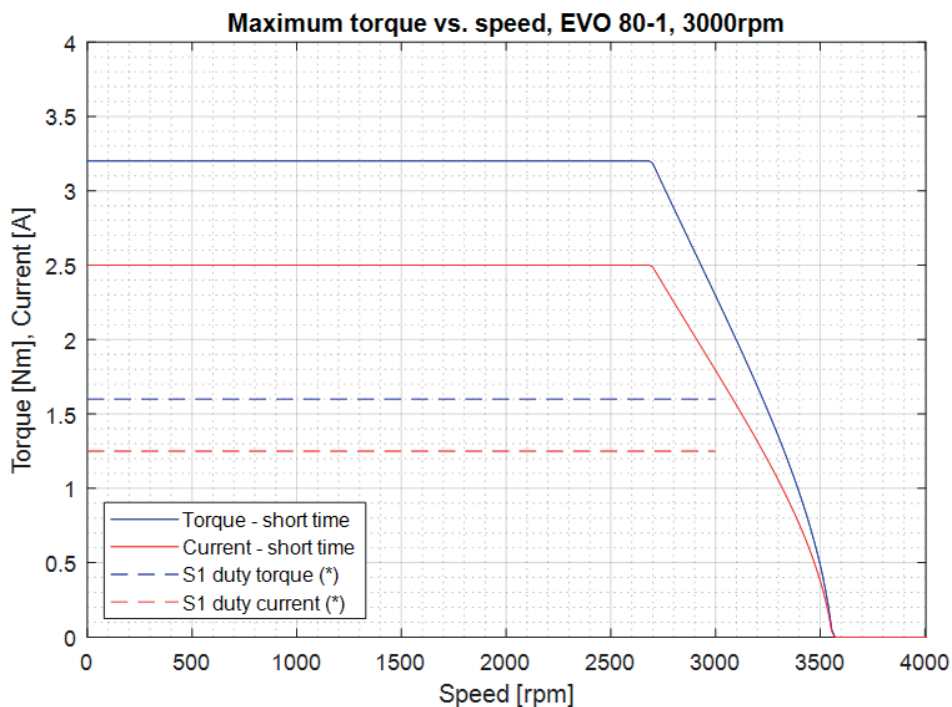

SK EVO 80-2 3.000 r/min

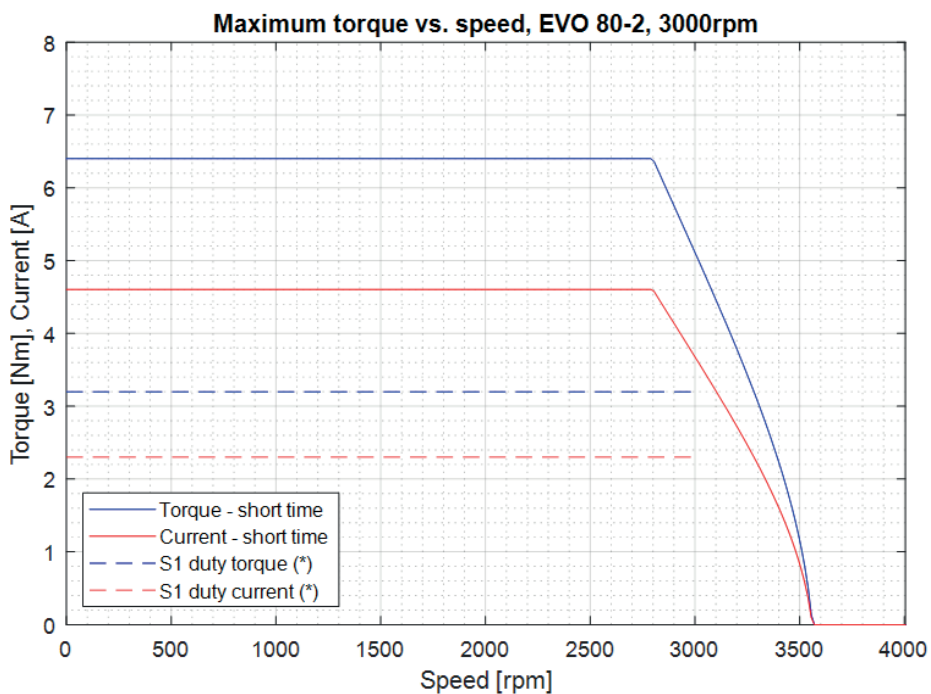

SK EVO 80-3 3.000 r/min

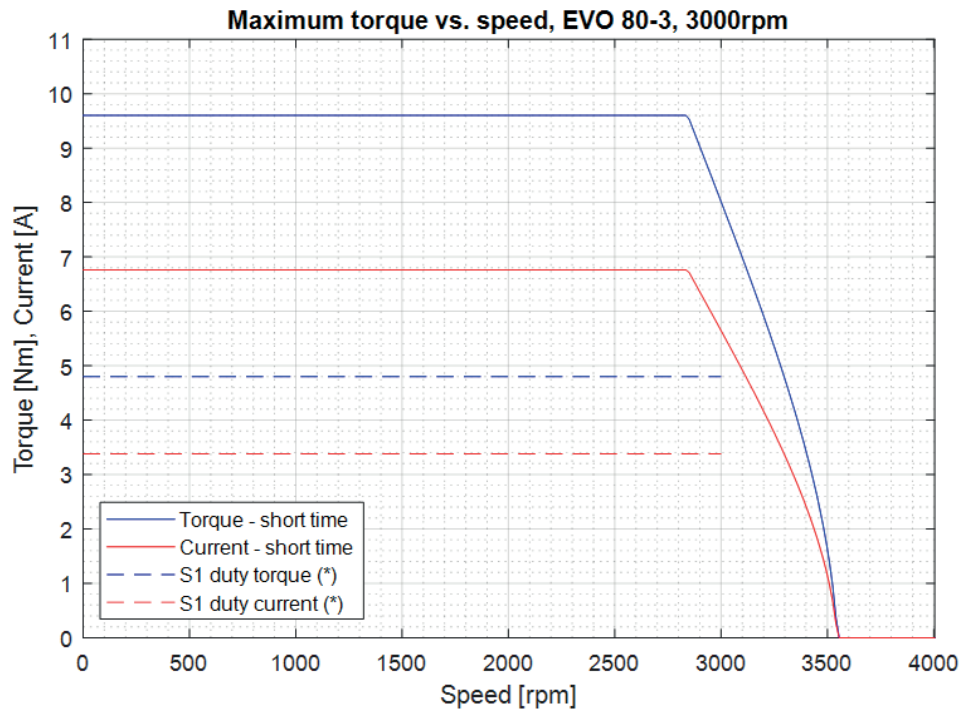

Motor characteristics

SK EVO 200-1 2.100 r/min

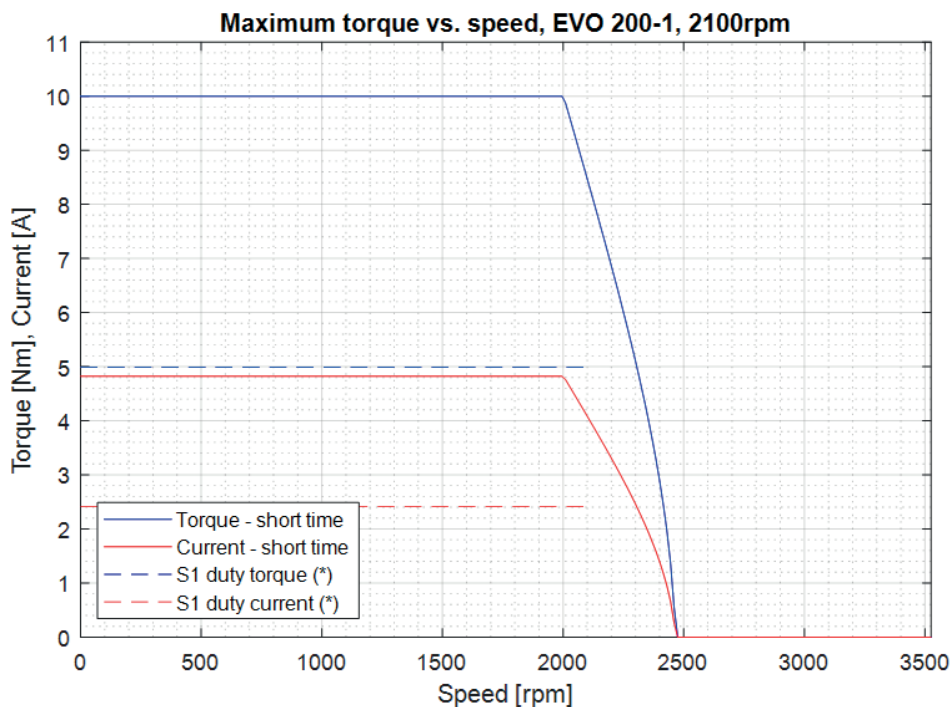

SK EVO 200-2 2.100 r/min

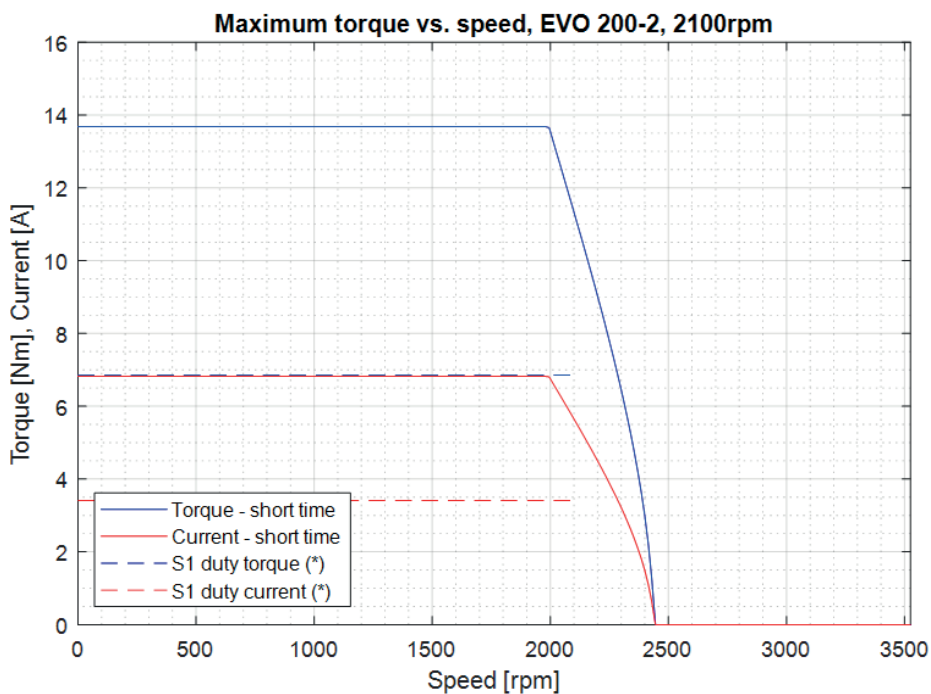

SK EVO 200-3 2.100 r/min

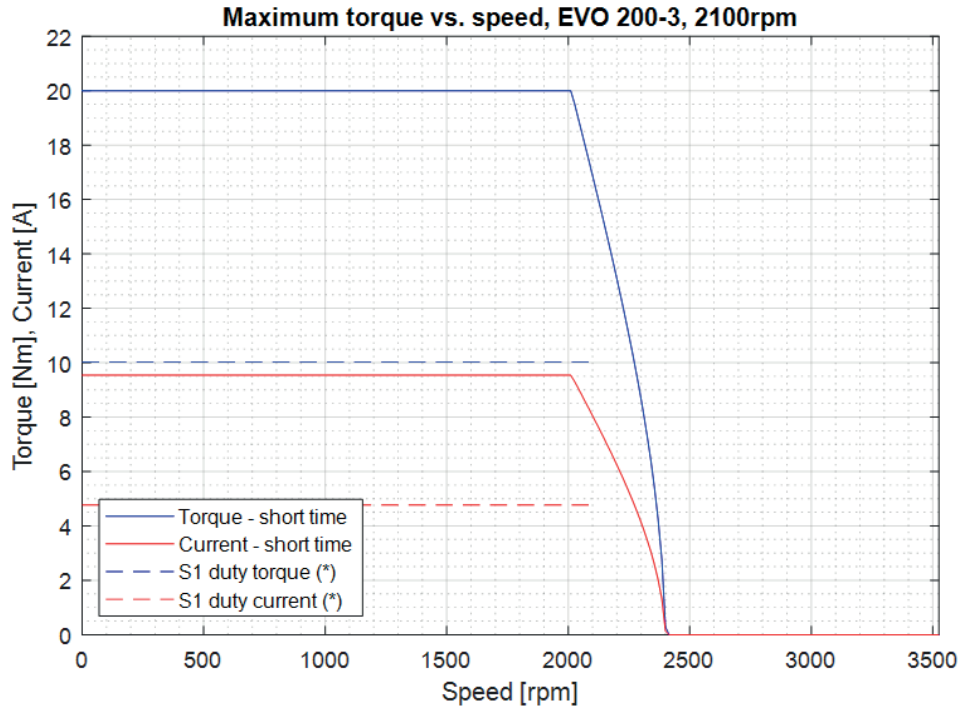

SK EVO 200-4 2.100 r/min

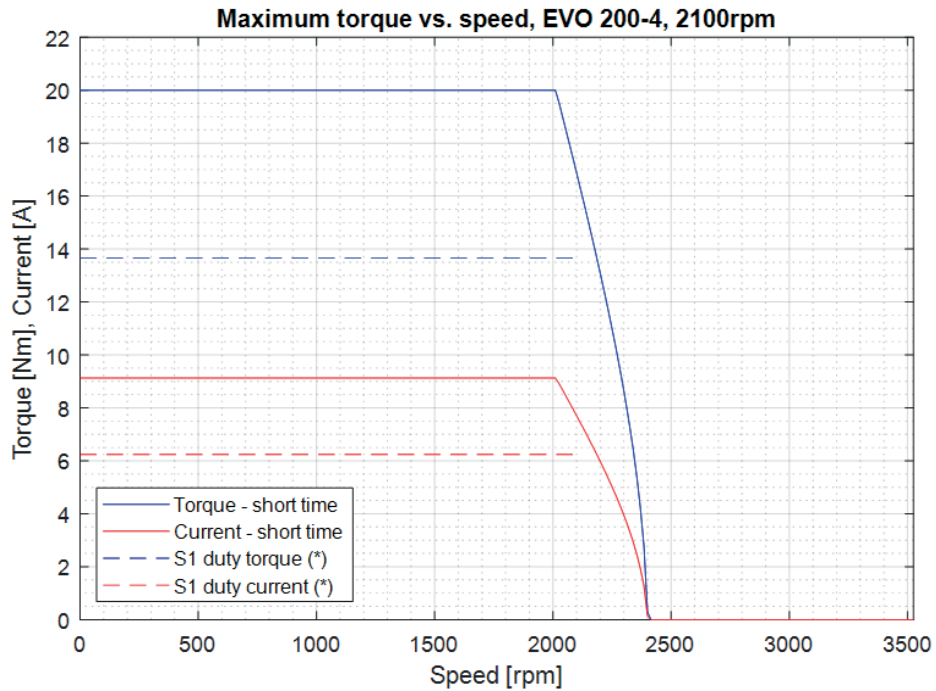

Motor characteristics

SK EVO 200-1 3.000 r/min

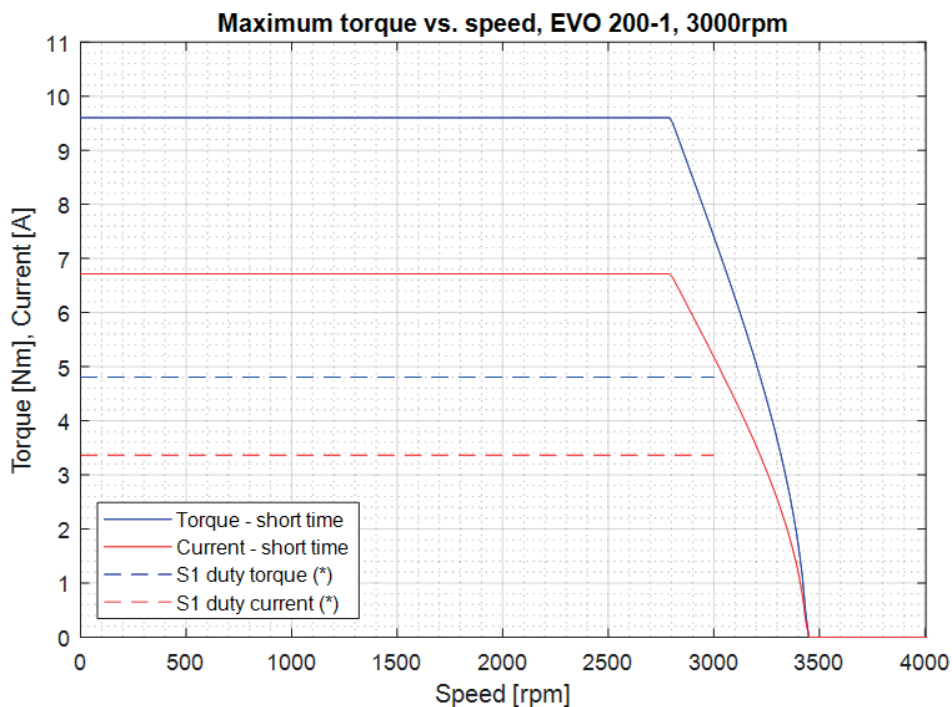

SK EVO 200-2 3.000 r/min

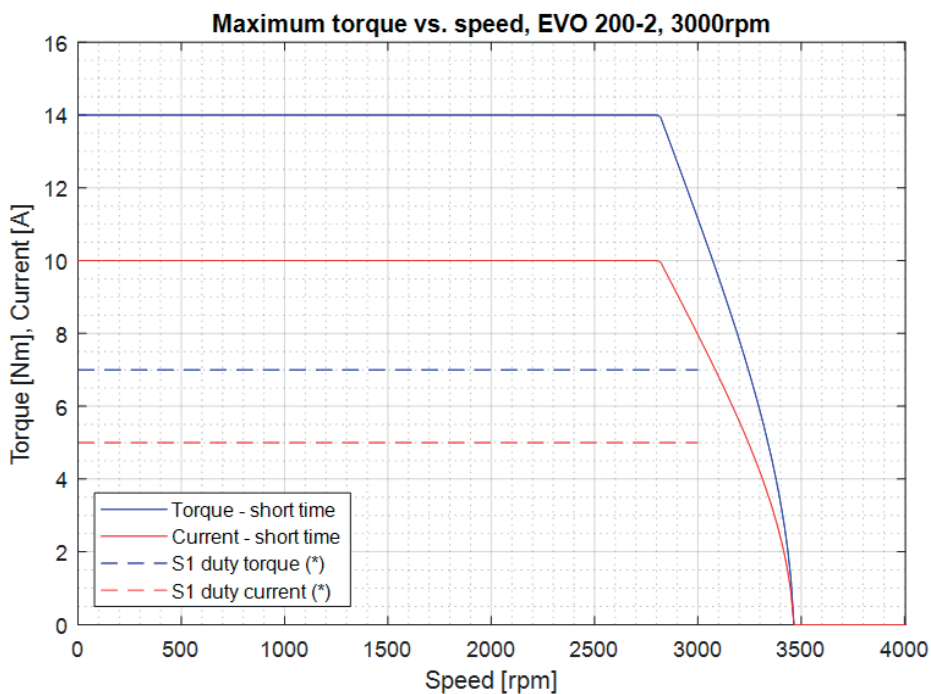

SK EVO 200-3 3.000 r/min

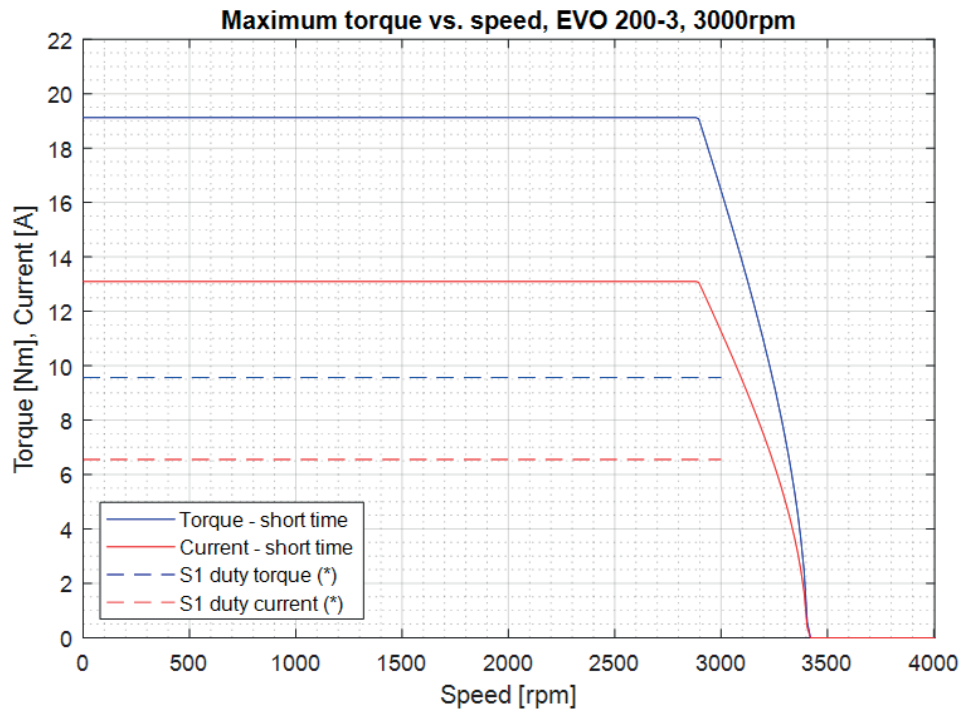

(*) The holding torques are to be read from the according table. Holding torque is not to be read from the speed-torque motor characteristic.



SK EVO 80

B5 AF

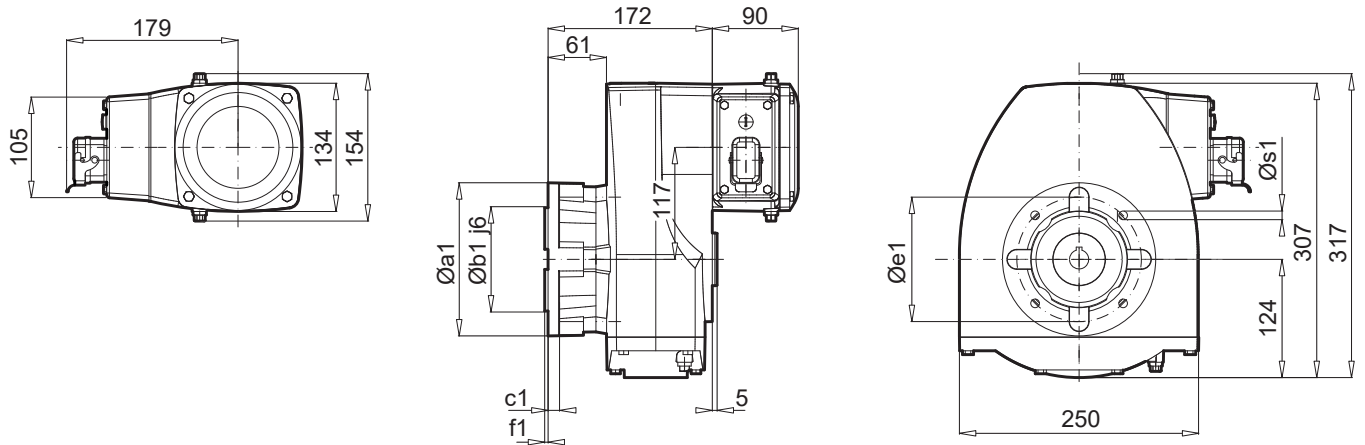

$\varnothing a1$	$\varnothing b1$	$c1$	$\varnothing e1$	$f1$	$\varnothing s1$
160	110	12	130	4,0	4 x 9
200	130	12	165	4,0	4 x 9

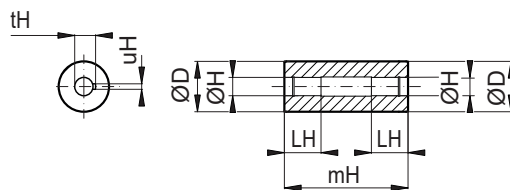
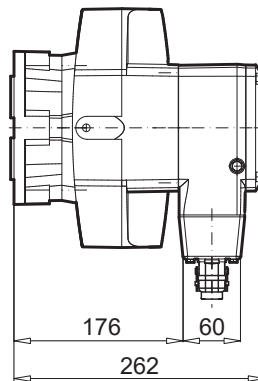

$\varnothing D$	$\varnothing H^{H7}$	$\varnothing H$	mH	LH	tH	uH
55	20	1.0000"	135	40	22,8	6
55	25	1.1250"	135	40	28,3	8
55	30	1.1825"	135	50	33,3	8
55	35	1.2500"	135	50	38,3	10
55	40	1.4375" 1.5000"	135	50	43,3	12

All dimensions in mm unless otherwise indicated.

SK EVO 80

B14 AZ

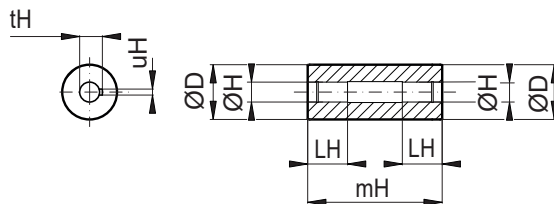
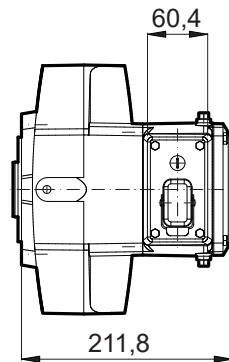
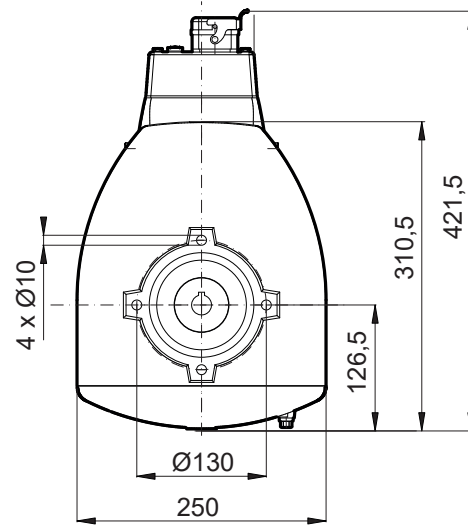
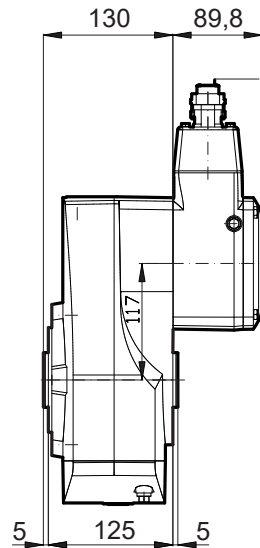
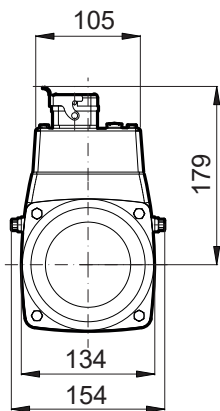

ØD	ØH ^{H7}	ØH	mH	LH	tH	uH
55	20	1.0000"	135	40	22,8	6
55	25	1.1250"	135	40	28,3	8
55	30	1.1825"	135	50	33,3	8
55	35	1.2500"	135	50	38,3	10
55	40	1.4375" 1.5000"	135	50	43,3	12

All dimensions in mm unless otherwise indicated.

B14 AZ BRE

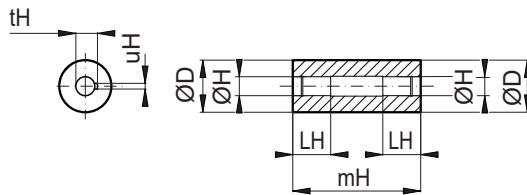
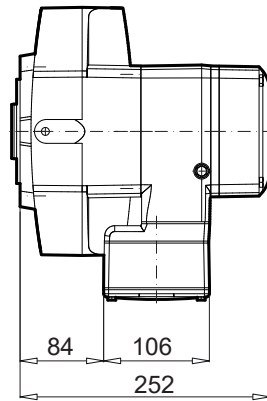
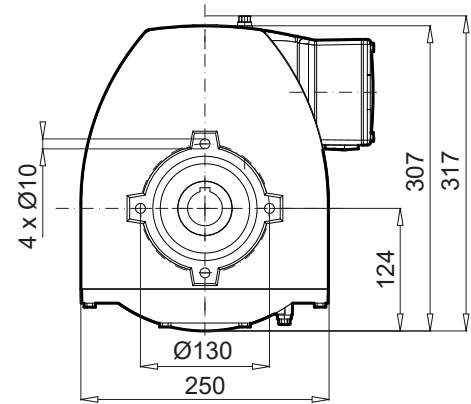
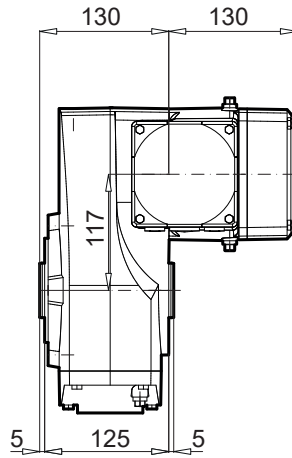
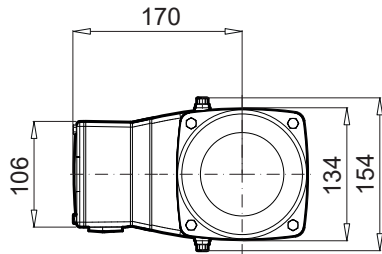

ØD	ØH ^{H7}	ØH	mH	LH	tH	uH
55	20	1.0000"	135	40	22,8	6
55	25	1.1250"	135	40	28,3	8
55	30	1.1825"	135	50	33,3	8
55	35	1.2500"	135	50	38,3	10
55	40	1.4375" 1.5000"	135	50	43,3	12

All dimensions in mm unless otherwise indicated.

B14 AZDH

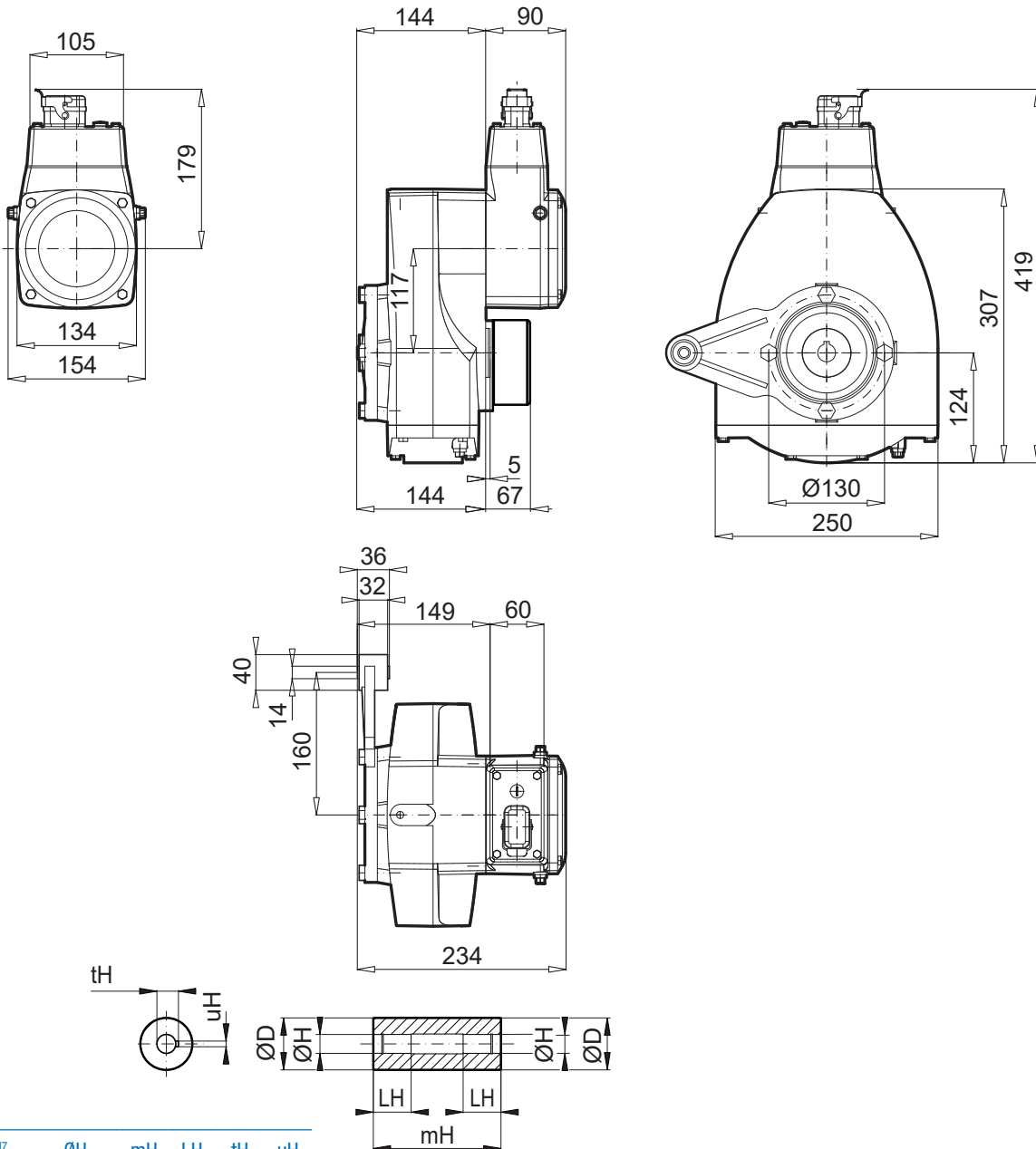

$\text{Ø}D$	$\text{Ø}H^{H7}$	$\text{Ø}H$	mH	LH	tH	uH
55	20	1.0000"	135	40	22,8	6
55	25	1.1250"	135	40	28,3	8
55	30	1.1825"	135	50	33,3	8
55	35	1.2500"	135	50	38,3	10
55	40	1.4375" 1.5000"	135	50	43,3	12

All dimensions in mm unless otherwise indicated.

B14 AZMH

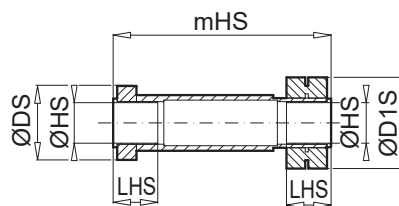
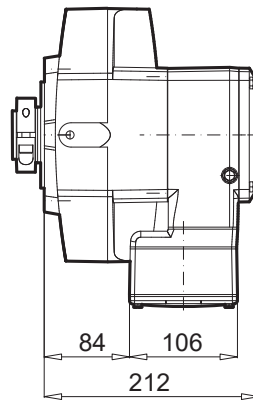
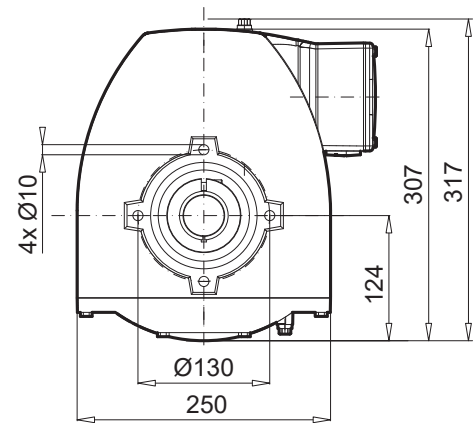
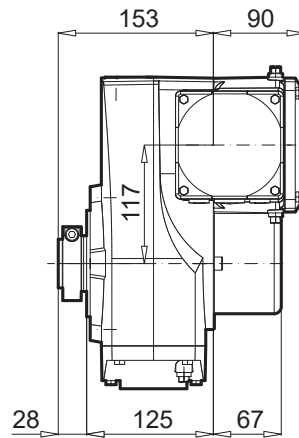
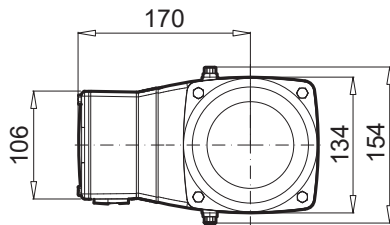

ØDS	ØD1S	ØHS ^{H7}	ØHS	mHS	LHS
73	90	30	1.1825 ^{h7}	215	44
73	90	35	1.2500 ^{h7}	215	44
73	90	40	1.4375 ^{h7} 1.5000 ^{h7}	215	54

All dimensions in mm unless otherwise indicated.

SK EVO 200

B5 AF

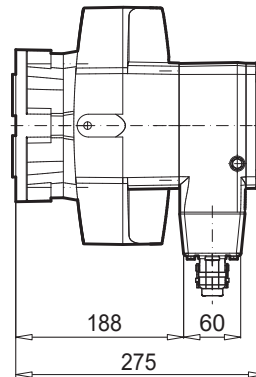
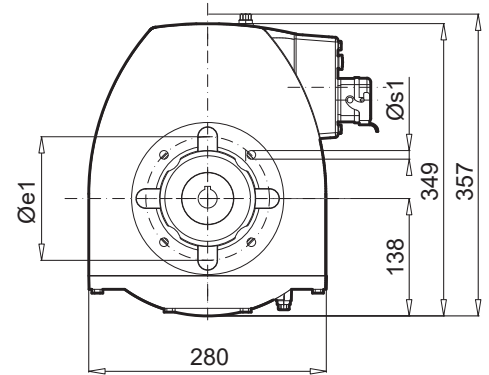
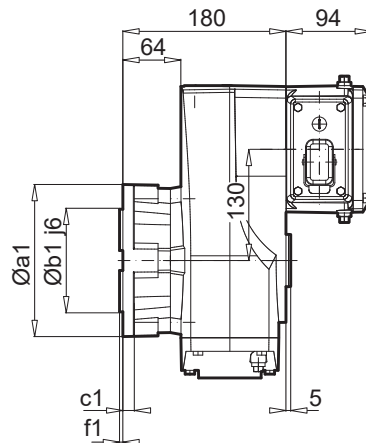
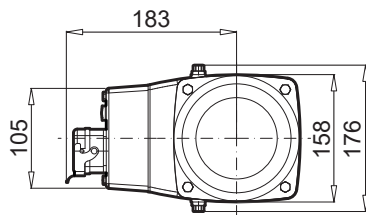

Øa1	Øb1	c1	Øe1	f1	Øs1
160	110	12	130	4,0	4 x 9
200	130	12	165	4,0	4 x 9
250	180	15	215	4,0	4 x 14

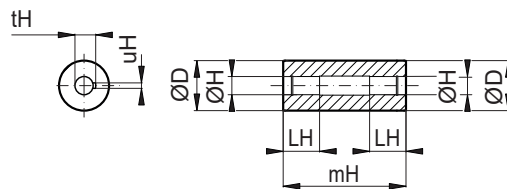

ØD	ØH ^{H7}	ØH	mH	LH	tH	uH
55	20	1.0000"	135	40	22,8	6
55	25	1.1250"	135	40	28,3	8
55	30	1.1825"	135	50	33,3	8
55	35	1.2500"	135	50	38,3	10
55	40	1.4375" 1.5000"	135	50	43,3	12

All dimensions in mm unless otherwise indicated.

B5 AF BRE

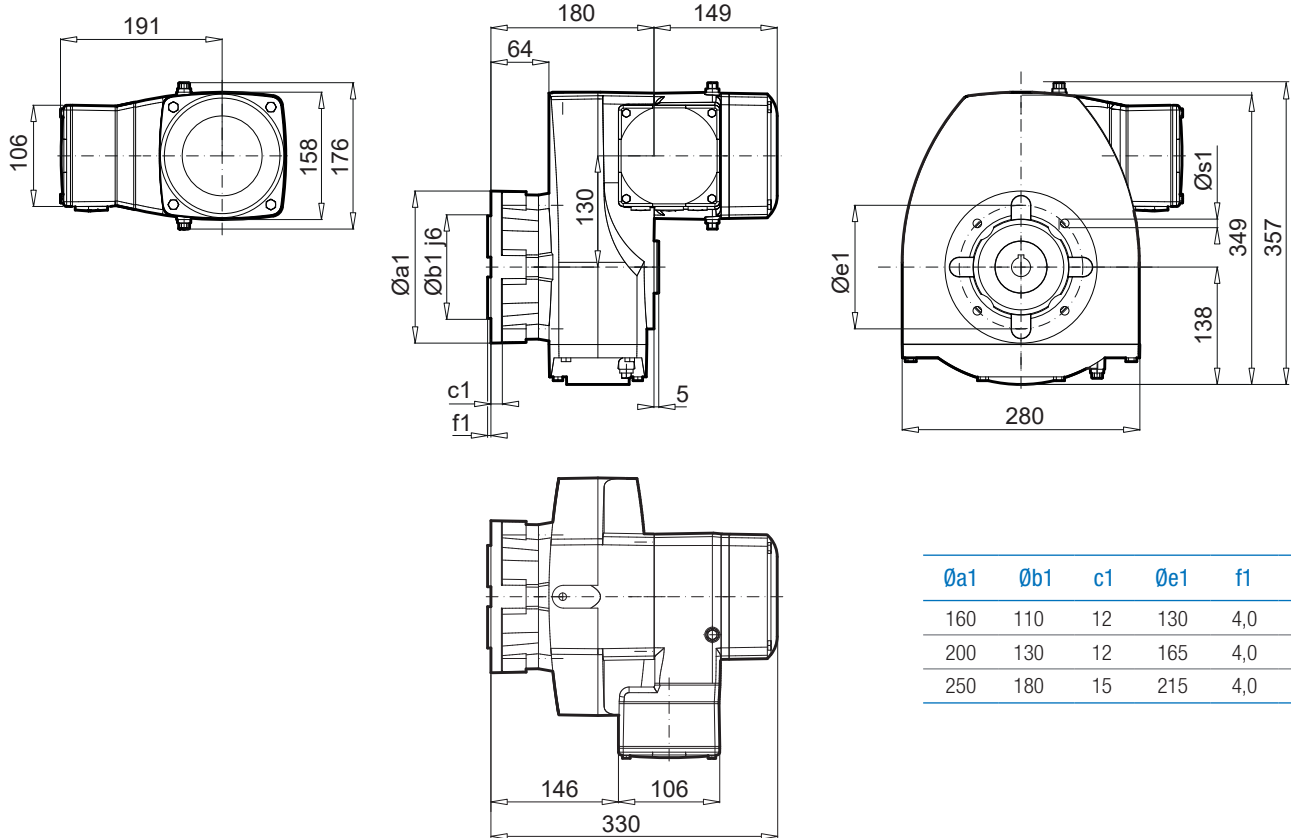

$\varnothing a1$	$\varnothing b1$	$c1$	$\varnothing e1$	$f1$	$\varnothing s1$
160	110	12	130	4,0	4 x 9
200	130	12	165	4,0	4 x 9
250	180	15	215	4,0	4 x 14

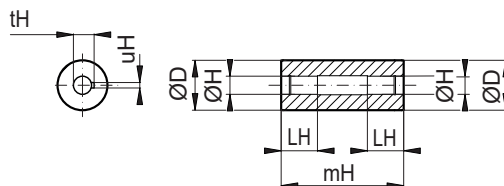

$\varnothing D$	$\varnothing H^{H7}$	$\varnothing H$	mH	LH	tH	uH
55	20	1.0000"	135	40	22,8	6
55	25	1.1250"	135	40	28,3	8
55	30	1.1825"	135	50	33,3	8
55	35	1.2500"	135	50	38,3	10
55	40	1.4375" 1.5000"	135	50	43,3	12

All dimensions in mm unless otherwise indicated.

B14 AZ

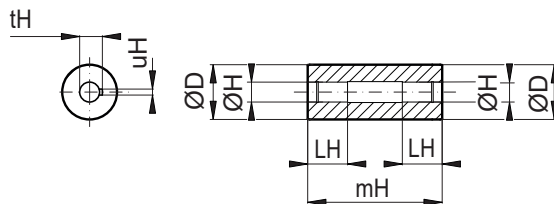
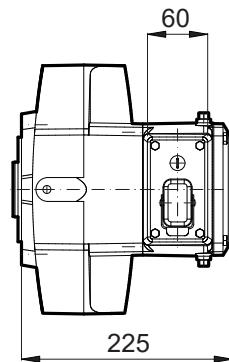
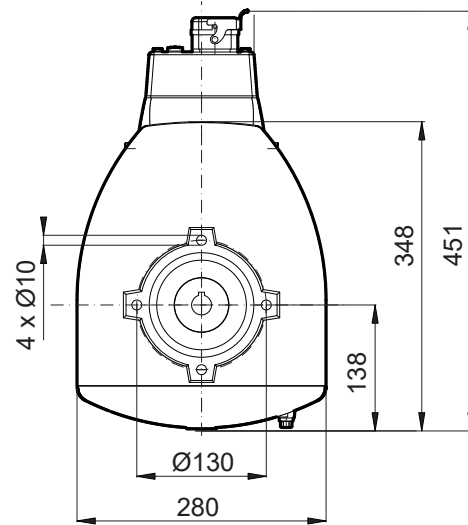
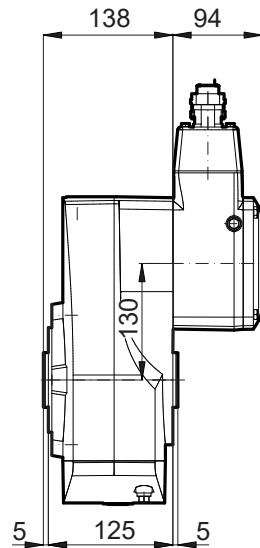
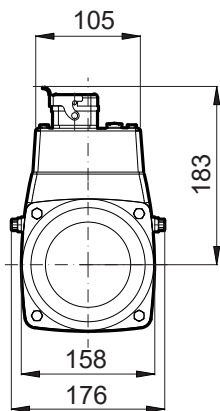

ØD	ØH ^{H7}	ØH	mH	LH	tH	uH
55	20	1.0000"	135	40	22,8	6
55	25	1.1250"	135	40	28,3	8
55	30	1.1825"	135	50	33,3	8
55	35	1.2500"	135	50	38,3	10
55	40	1.4375" 1.5000"	135	50	43,3	12

All dimensions in mm unless otherwise indicated.

B14 AZ BRE

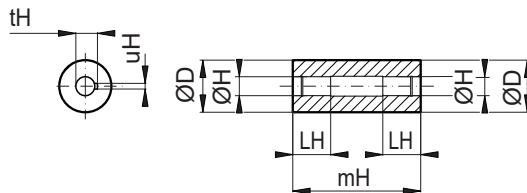
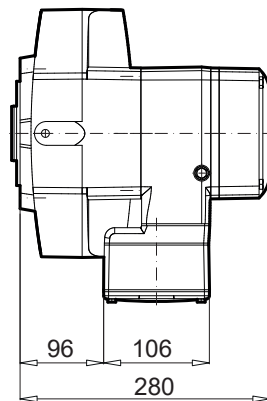
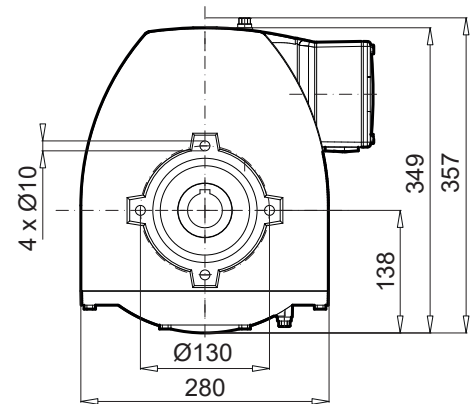
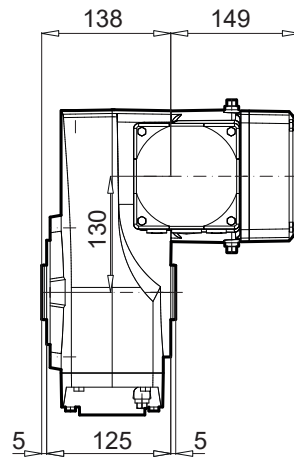
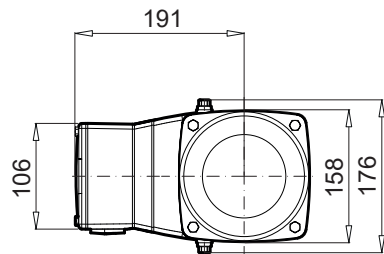

ØD	ØH ^{H7}	ØH	mH	LH	tH	uH
55	20	1.0000"	135	40	22,8	6
55	25	1.1250"	135	40	28,3	8
55	30	1.1825"	135	50	33,3	8
55	35	1.2500"	135	50	38,3	10
55	40	1.4375" 1.5000"	135	50	43,3	12

All dimensions in mm unless otherwise indicated.

B14 AZDH

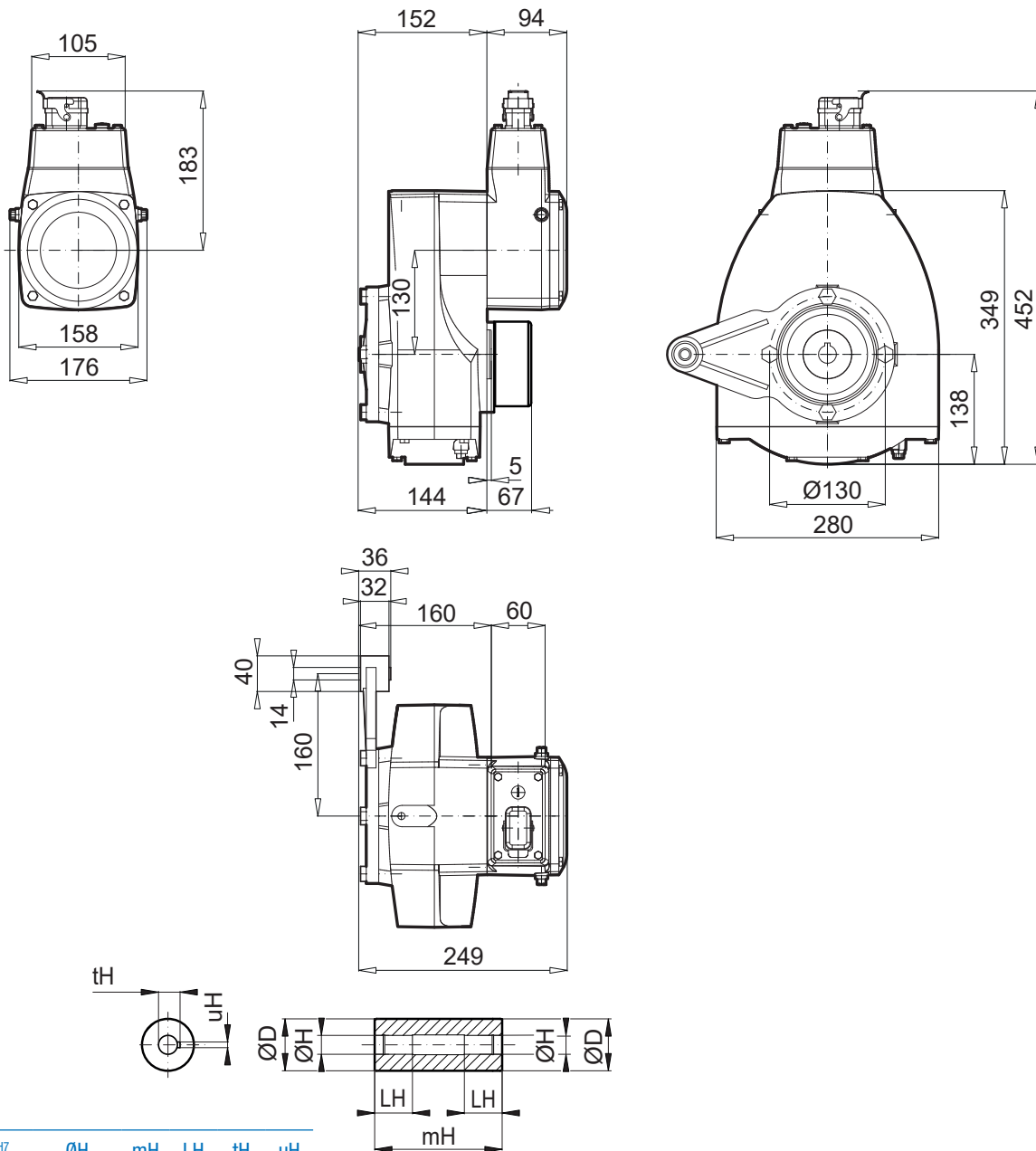

ØD	ØH ^{H7}	ØH	mH	LH	tH	uH
55	20	1.0000"	135	40	22,8	6
55	25	1.1250"	135	40	28,3	8
55	30	1.1825"	135	50	33,3	8
55	35	1.2500"	135	50	38,3	10
55	40	1.4375" 1.5000"	135	50	43,3	12

All dimensions in mm unless otherwise indicated.

B14 AZMH

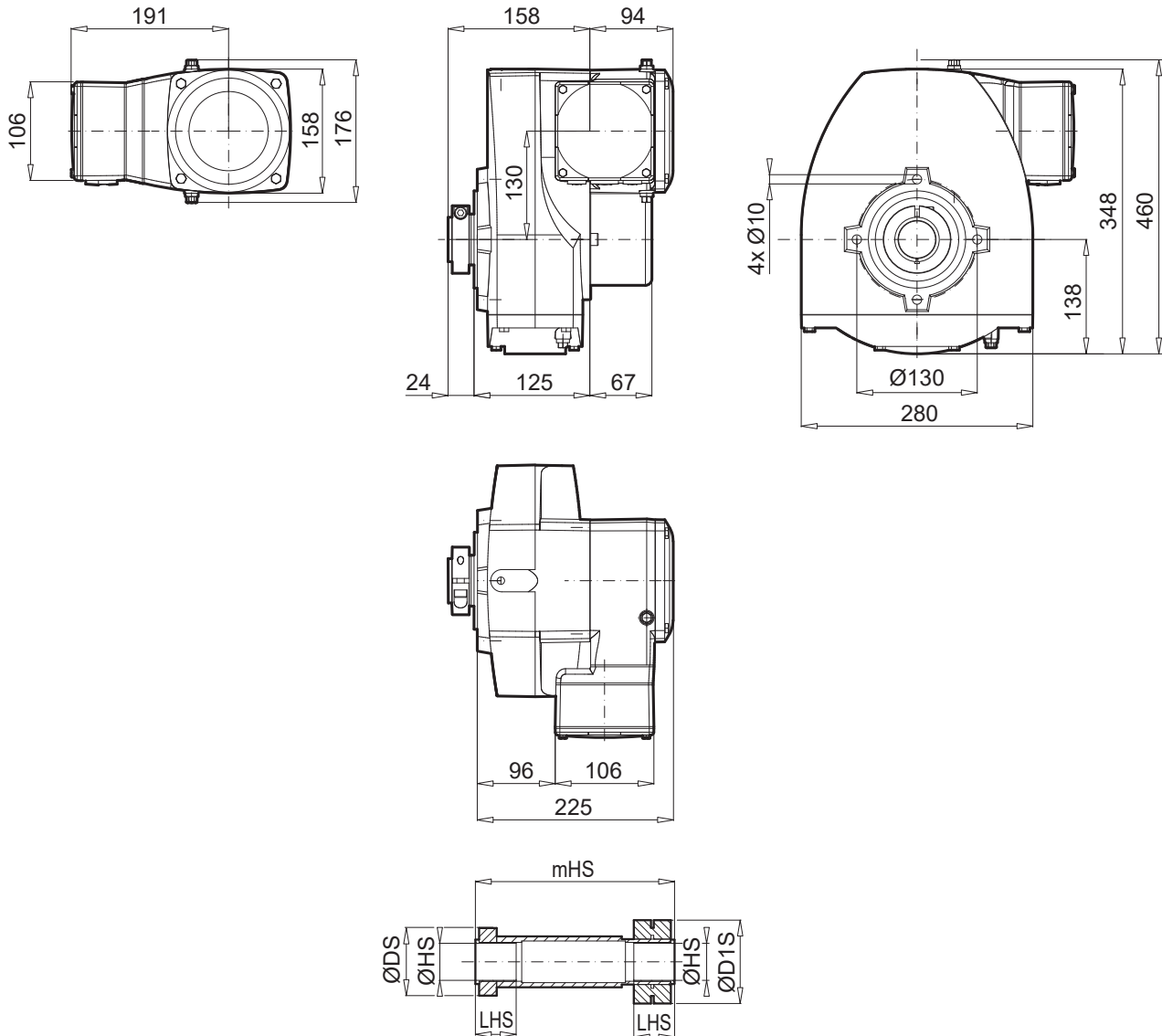

ØDS	ØD1S	ØHS ^{H7}	ØHS	mHS	LHS
73	90	30	1.1825 ^{h7}	215	44
73	90	35	1.2500 ^{h7}	215	44
73	90	40	1.4375 ^{h7} 1.5000 ^{h7}	215	54

All dimensions in mm unless otherwise indicated.

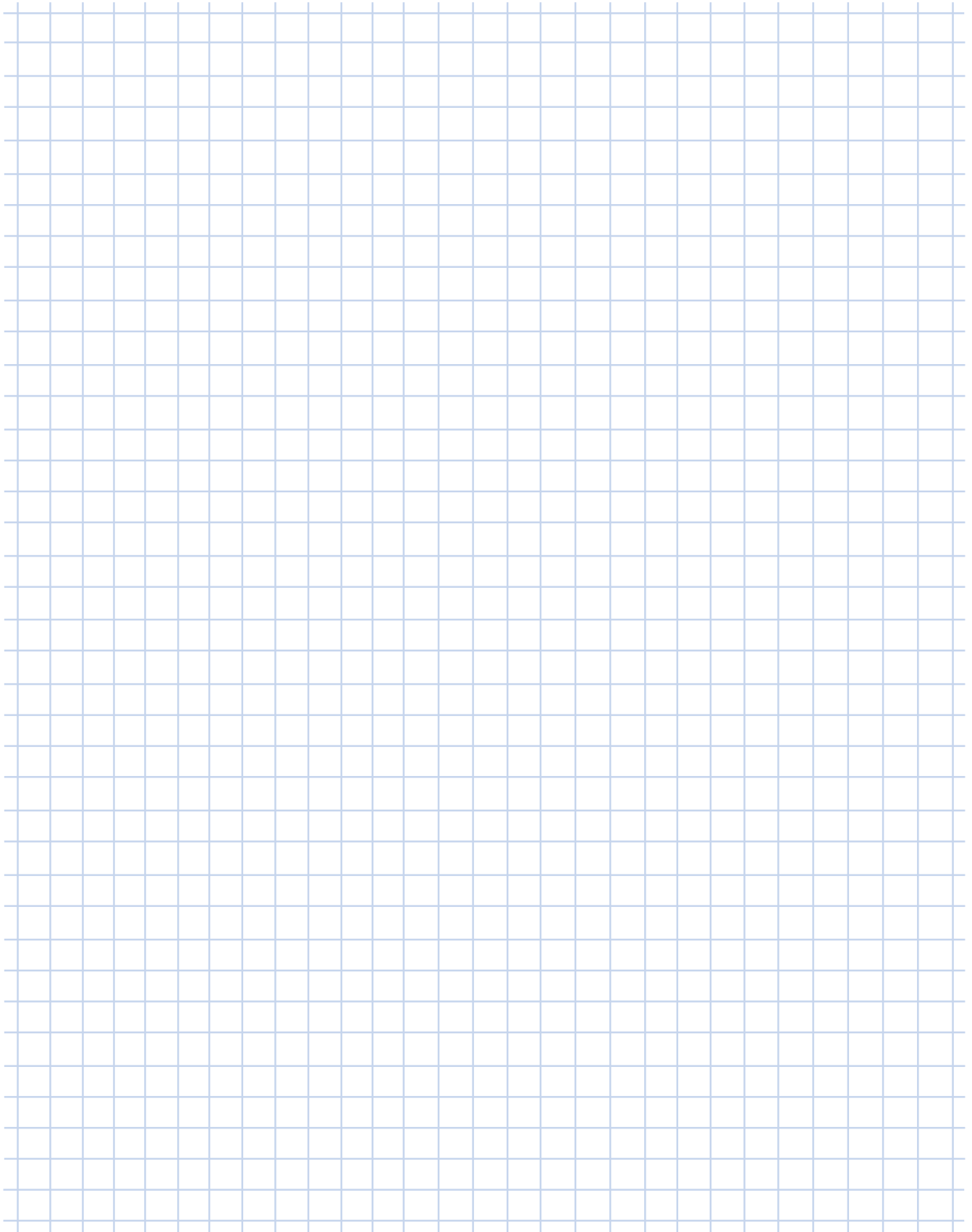
A large grid area for taking notes, consisting of a 20x30 grid of light blue lines.

Selections from the NORD® range

G1000 Fixed speeds

UNICASE housing 50 / 60 Hz

- NORDBLOC.1® helical in-line geared motor
- Helical geared motors
- Parallel shaft geared motors
- Bevel geared motors
- Helical worm geared motors

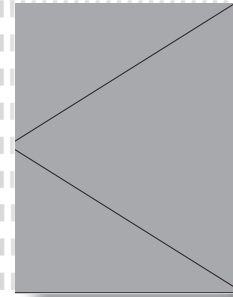

G4014 Electronic variable speed gear units

- NORDBLOC.1® helical in-line geared motor
- Helical geared motors
- Parallel shaft geared motors
- Bevel geared motors
- Helical worm geared motors



G1050 MAXXDRIVE® industrial gear units

UNICASE housing 50 / 60 Hz

- Helical gear units
- Helical bevel gear units

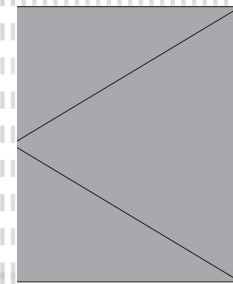

G1035 UNIVERSAL worm gear units

- SI and SMI

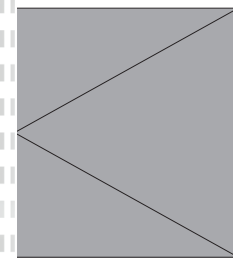

F3018_E3000 Frequency inverter SK 180E

F3020_E3000 Frequency inverter SK 200E

F3060_E3000 NORDAC PRO
frequency inverter SK 500P



EN

Headquarters:

Getriebebau NORD GmbH & Co. KG

Getriebebau-Nord-Str. 1

22941 Bargteheide, Deutschland

T: +49 45 32 / 289 0

F: +49 45 32 / 289 22 53

info@nord.com