

NORDBLOC.1[®] Two-Stage Helical Bevel Gear Units

Performance and Design



Complete drive solutions from a single source



NORD Delivers

NORD offers first-class customer service and support along with full-featured drive solutions that can tackle the toughest requirements. All components are carefully selected and precisely configured to meet your exact specifications. In the rare case that standard components won't meet your needs, our in-house engineering team will work with you to design custom components or a complete customized system.

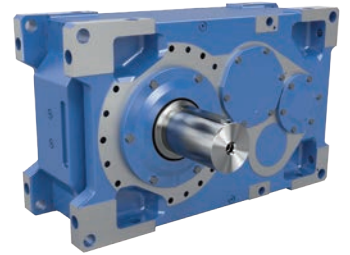

Reduce Lead Times and Decrease Inventory

- ▶ Fastest lead times in the industry with NO expedite fees
- ▶ Over 20,000,000 standard configurations to reduce or eliminate the need for custom components
- ▶ Modular drives, motors, and electronic controls minimize inventory of replacement units and parts



Global Product Designs, Standards, and Support

- ▶ Innovative, industry-standard products to support a wide range of applications
- ▶ Global sales and support network
- ▶ Dedicated mechanical and electrical application engineers ready to assist you
- ▶ Online resources available to you any time
- ▶ 24/7/365 emergency breakdown service

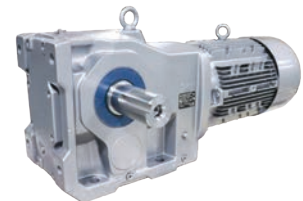

Increase Efficiency and Reduce Operation Costs

- ▶ myNORD online tools for fast selection, configuration, ordering, and tracking of your drive units
- ▶ Drive systems that are perfectly matched to your application for optimum performance and energy efficiency
- ▶ Program personalization, such as weekly shipment schedules and custom nameplates
- ▶ Partner with a company that is easy to do business with and wants to see you succeed!



NORDBLOC.1® Helical Bevel Gear Units

NORDBLOC.1 right-angle helical bevel gear units provide superior performance in a compact, 97% efficient modular design. UNICASE™ housings are manufactured to precision from high-strength corrosion-resistant aluminum alloy and are designed using the latest in FEM (Finite Element Modeling) technology. These advanced technologies coupled with NORD's manufacturing precision ensure an accurate alignment of all bearings, seals, internal shafts, and gears for a long operating life with minimal maintenance.

NORDBLOC.1 helical bevel gear units include the SK 92.1 and SK 93.1 series with identical product range but varied housing designs. The 92.1 series features an open housing design for improved heat dissipation in industries such as intralogistics, airports, and parcel distribution centers. The 93.1 housing is an easy to clean, smooth body design ideal for heavy wash-down environments like those in the food and beverage industry. Each series includes 6 sizes ranging in torque capacity from 443 to 5,842 lb-in and performance of 0.16 – 12.50 hp.

Large oversized output bearings facilitate quick assembly, provide large bore capacities, high radial load capacity, and extended life. In addition, NORD offers a foot-plate kit for both housing designs to easily retrofit industry standard single-reduction worm gear units. A variety of paint options and protective surface treatments are optional with both housing designs.

A variety of mounting options, output shaft configurations, and flexible input options ensure high application adaptability.

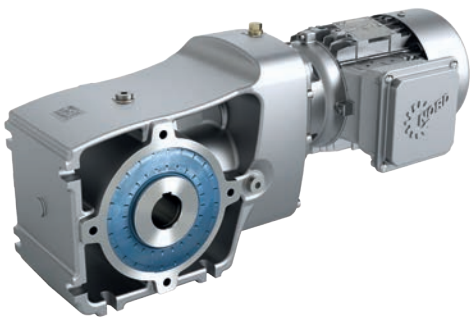

92.1 Series Key Features:

- ▶ Universal housing - feet and B14 face flange
- ▶ B5 flange, torque arm, or foot plate mounting kit optional
- ▶ Integral motor, NEMA, IEC, or solid shaft input
- ▶ Improved heat dissipation



93.1 Series Key Features:

- ▶ Smooth bodied housing with B14 face flange
- ▶ B5 flange, torque arm, tapped foot holes, and foot plate kit optional
- ▶ Integral motor, NEMA, IEC, or solid shaft input
- ▶ Ideal for hygienic or wash-down environments

Product Features

Alluminum Alloy Housing

Light weight, high strength, optimal heat dissipation, and natural corrosion resistance. Flange or torque-arm mount options available.

Two Housing Styles

The 92.1 and 93.1 housing styles offer a multitude of mounting options and benefits to fit your application needs.

Lower Cost

Up to 40% lower than traditional helical-bevel gear unit designs.

Cooler Operating Temperatures

With high efficiencies and optimized housing design, our units dissipate heat more effectively than traditional worm drives.

97% Gear Efficiency

Gearing with ratings up to AGMA 13 quality.

Long Gear Life

Two-stage bevel gearing is wear free for infinite life.

Input Configuration

Direct motor mounting, NEMA, IEC, and free input shaft options are readily available. Adaptation to servo motors is possible.

Output Shaft

Hollow, solid, or double output shaft designs are available along with keyed, GRIPMAXX™, and shrink disc options.

Output Bearings

Oversized bearings provide high radial and axial load capacities and long service life.

QUADRILIP™ Oil Seals

Double-lip oil seals provide extra sealing and protection against the elements.

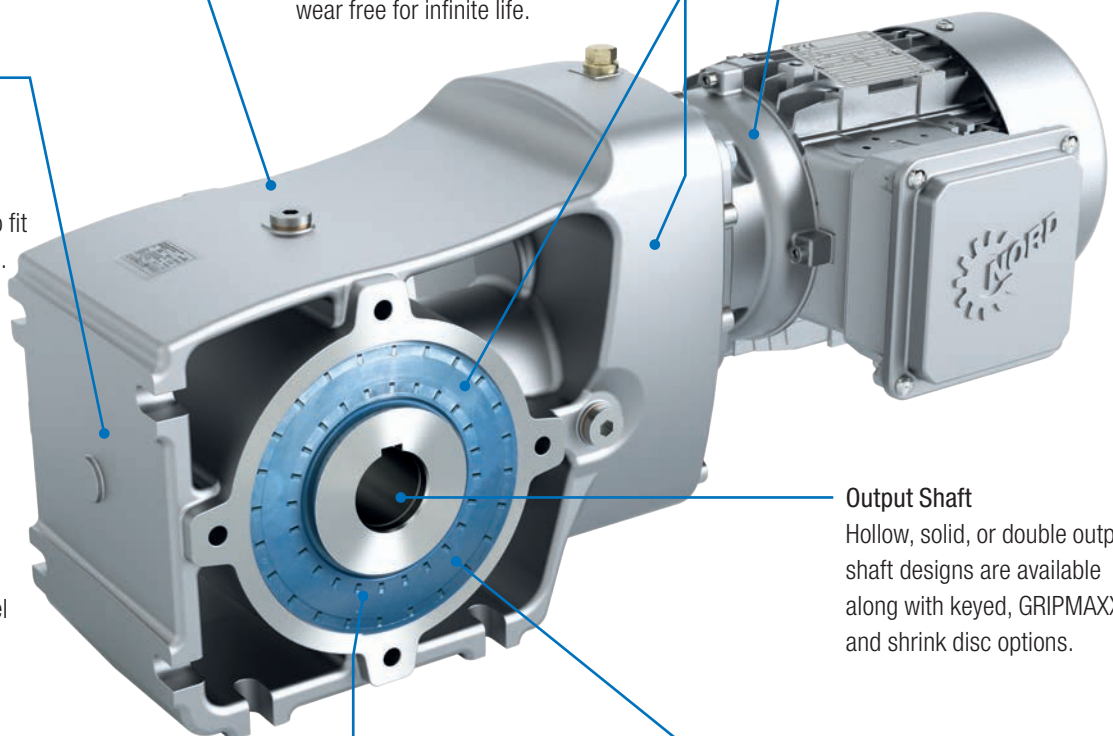

UNICASE™ Single Piece Housing

NORD's heavy-duty, one-piece housings are precisely machined to exacting standards with internal reinforcements further increasing strength and rigidity. All bearings and seal seats are contained within the casting, eliminating splits or bolt-on carriers that can weaken the housing and allow oil leakage. Bores and mounting faces are machined in one step, producing extremely precise tolerances – thus ensuring a longer service life for all components and accurate positioning of gear teeth, bearings, and seals.

- ▶ Increased torsional strength and rigidity
- ▶ Eliminates housing splits and bolt-on carriers
- ▶ Leak-free housing design
- ▶ Versatile mounting options and accessory kits

Modular Construction

All NORD products are modular in design and offer a high degree of flexibility. The 92.1 and 93.1 two-stage helical bevel gear units provide mounting versatility including:

- ▶ Foot mounted
- ▶ B5 flange mounted
- ▶ B14 face flange mounted

92.1 and 93.1 gear units can also be configured with a number of different input components including:

- ▶ Integral motor (gear motor)
- ▶ NEMA C-face motor adapter
- ▶ IEC B5 motor adapter
- ▶ Solid input shaft
- ▶ Custom motor adapter (servo, hydraulic motors, and more)

Factory Oil Filled

NORD factory-filled gear units allow for easy commissioning of the gear unit and prevent damage caused by dry start-ups. Each unit is filled with quality gear lubricant that is recognized by the industry.

- ▶ Maintenance free / lubricated-for-life
- ▶ High-quality long-life synthetic lubricant
- ▶ USDA H1 lubrication readily available
- ▶ Optional venting capabilities

Oversized Output Shaft Bearings

NORD modular worm gear units are designed with oversized output bearings. Bearing sizes are significantly larger than required to absorb the internal forces within the gear unit. As a by-product of the larger bearings, the internal shaft diameters increase, resulting in increased shaft strength, durability, and larger hollow-shaft bore capacities. Compared to competitive worm gear units, NORD'S intentional selection of oversized output bearings provides the following advantages:

- ▶ Longer bearing life
- ▶ Ability to support large overhung and thrust loads
- ▶ Larger internal shaft diameters / increased strength
- ▶ Larger hollow bore capacities

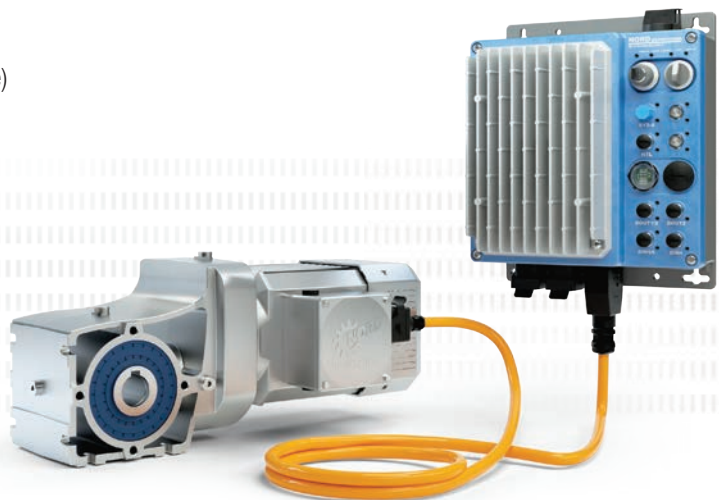

Gearbox Options

Shaft Options

The following shaft options are available:

- ▶ Keyed hollow shaft (A)
- ▶ Solid output shaft (V)
- ▶ Double solid output shaft (L)
- ▶ Shrink disc (S)
- ▶ GRIPMAXX™ (M)
- ▶ Fixing element kit (B)
- ▶ Hollow shaft cover (H)
- ▶ Stainless steel output shaft (SM)
- ▶ Special shafts upon request

Shaft Option Examples

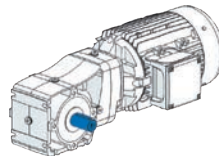

Solid Output Shaft

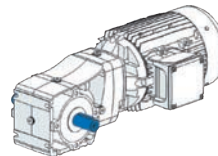

Double Solid Output Shaft

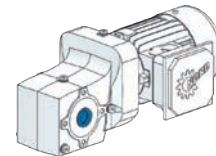

Keyed Hollow Shaft

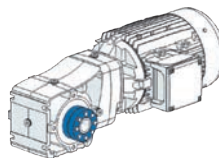

Shrink Disc/GRIPMAXX™

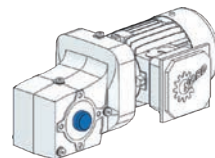

Fixing Kit

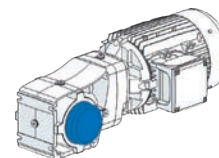

Hollow Shaft Cover

Mounting Options

The following mounting options are available:

- ▶ B5 flange (F)
- ▶ B5 flange pilot removal (PR)
- ▶ Torque arm (D)
- ▶ Tapped foot holes (93.1 series only)
- ▶ Industry standard worm adapter plate

Mounting Option Examples

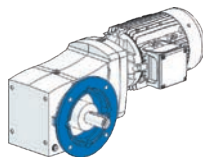

B5 Mounting Flange

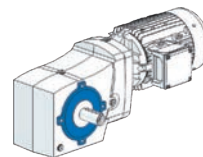

B14 Mounting Flange

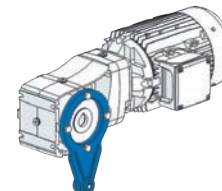

Torque Arm

Protective Features

The following protective options are available:

- ▶ Alternative paint coatings
- ▶ AUTOVENT™
- ▶ Fluoro rubber seals (FKM)
- ▶ Long term storage (LL)
- ▶ Oil sight glass (OSG)

Input Options

The following input options are available:

- ▶ Integral gear motor
- ▶ NEMA C-face adapter
- ▶ NEMA C-face adapter with motor
- ▶ Input shaft
- ▶ IEC adapter
- ▶ IEC adapter with motor

Gear Unit Ratings

Unit Size	Max Torque*		Ratio Range Min-Max	Solid Shaft Ø		Keyed Hollow Shaft Ø					Shrink Disc Shaft Ø	
	[lb-in]	[Nm]		[in]	[mm]	Std-[in]	Opt-[in]	Opt-[in]	Opt-[in]	[mm]	[in]	[mm]
SK 9X0072.1	493	56	3.03 - 47.67	0.750	20	0.750	-	-	-	20	0.750	20
SK 9X072.1	717	81	3.58 - 61.88	0.750	20	0.750	0.500	-	-	25	1.000	25
SK 9X172.1	1062	120	3.58 - 70.00	0.750	25	1.000	0.750	-	-	25	1.000	25
SK 9X372.1	1938	219	3.72 - 55.49	1.000	30	1.1875	1.250	1.4375	1.500	30	1.1875	30
SK 9X672.1	3222	364	4.36 - 48.56	1.250	35	1.375	1.4375	1.500	-	35	1.375	35
SK 9X772.1	5841	660	4.17 - 66.96	1.375	40	1.500	1.4375	-	-	40	1.500	40

* Torque may vary by ratio

Explosion-protected NORD drive solutions

NORD offers secure solutions for dust explosion protection in line with ATEX directives.

NORD drive solutions are also environmentally friendly and help reduce operating costs and minimize CO₂ emissions.



- ▶ High efficiency helical bevel gear units achieve optimum power transmission performance
- ▶ NORD motors comply with international energy efficiency classes up to IE5+
- ▶ NORD variable frequency drives have energy saving functions to effectively reduce energy consumption

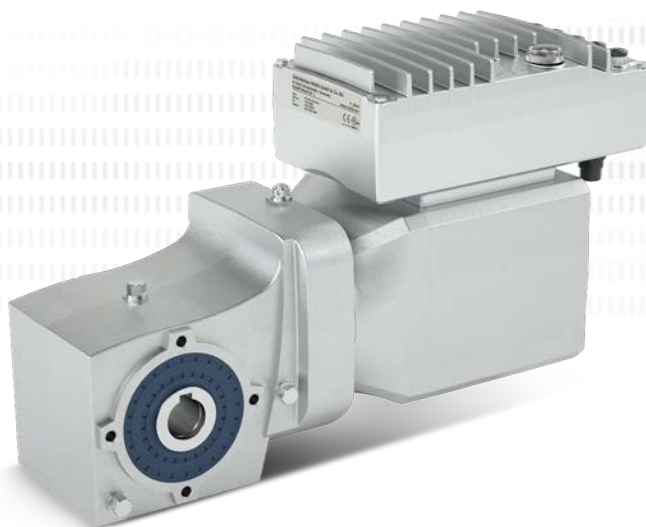

Motor Ratings

Inverter duty / Induction motor / TEFC

Synchronous speed 1800rpm @ 60Hz / 4-pole / Three-phase

1.15 service factor / continuous duty

40°C ambient / Up to 3300ft elevation

Class B temperature rise / Class F insulation



230/460V – 60Hz – Premium Efficiency

Motor Power		Output Speed [rpm]	Motor Type	
[hp]	[kW]		Integral	NEMA C-Face
0.16	0.12	1695	63 SP/4	63 SP/4-56C
0.25	0.18	1705	63 LP/4	63 LP/4-56C
0.33	0.25	1725	71 SP/4	71 SP/4-56C
0.50	0.37	1725	71 LP/4	71 LP/4-56C
0.75	0.55	1735	80 SP/4	80 SP/4-56C
1.00	0.75	1730	80 LP/4	80 LP/4-56C
1.00	0.75	1730	80 LP/4	80 LP/4-143TC
1.50	1.10	1740	90 SP/4	90 SP/4-145TC
2.00	1.50	1730	90 LP/4	90 LP/4-145TC
3.00	2.20	1765	100 LP/4	100 LP/4-182TC
4.00	3.00	1760	100 AP/4	100 AP/4-184TC
5.00	3.70	1755	112 MP/4	112 MP/4-184TC
7.50	5.50	1770	132 SP/4	132 SP/4-213TC
10.00	7.50	1765	132 MP/4	132 MP/4-215TC

575V – 60Hz – Premium Efficiency

Motor Power		Output Speed [rpm]	Motor Type	
[hp]	[kW]		Integral	NEMA C-Face
0.16	0.12	1695	63 SP/4	63 SP/4-56C
0.25	0.18	1705	63 LP/4	63 LP/4-56C
0.33	0.25	1725	71 SP/4	71 SP/4-56C
0.50	0.37	1725	71 LP/4	71 LP/4-56C
0.75	0.55	1735	80 SP/4	80 SP/4-56C
1.00	0.75	1730	80 LP/4	80 LP/4-56C
1.00	0.75	1730	80 LP/4	80 LP/4-143TC
1.50	1.10	1740	90 SP/4	90 SP/4-145TC
2.00	1.50	1730	90 LP/4	90 LP/4-145TC
3.00	2.20	1765	100 LP/4	100 LP/4-182TC
4.00	3.00	1760	100 AP/4	100 AP/4-184TC
5.00	3.70	1755	112 MP/4	112 MP/4-184TC
7.50	5.50	1770	132 SP/4	132 SP/4-213TC
10.00	7.50	1765	132 MP/4	132 MP/4-215TC

Inverter duty / Induction motor / TEFC
 Synchronous speed 1800rpm @ 60Hz / 4-pole / Three-phase
 1.15 service factor / continuous duty
 40°C ambient / Up to 3300ft elevation
 Class B temperature rise / Class F insulation



230/460V – 60Hz – Standard Efficiency

Motor Power		Output Speed [rpm]	Motor Type	
[hp]	[kW]		Integral	NEMA C-Face
0.16	0.12	1700	63 S/4	63 S/4-56C
0.25	0.18	1680	63 L/4	63 L/4-56C
0.33	0.25	1710	71 S/4	71 S/4-56C
0.50	0.37	1720	71 L/4	71 L/4-56C
0.75	0.55	1710	80 S/4	80 S/4-56C
1.00	0.75	1650	80 L/4	80 L/4-56C
1.50	1.10	1660	90 S/4	90 S/4-145TC
2.00	1.50	1660	90 L/4	90 L/4-145TC
3.00	2.20	1745	100 L/4	100 L/4-182TC
4.00	3.00	1760	100 LA/4	100 LA/4-184TC
7.50	5.50	1735	132 S/4	132 S/4-213TC
10.00	7.50	1735	132 M/4	132 M/4-215TC

575V – 60Hz – Standard Efficiency

Motor Power		Output Speed [rpm]	Motor Type	
[hp]	[kW]		Integral	NEMA C-Face
1.00	0.75	1650	80 L/4	80 L/4-56C
1.50	1.10	1660	90 S/4	90 S/4-145TC
2.00	1.50	1660	90 L/4	90 L/4-145TC
3.00	2.20	1745	100 L/4	100 L/4-182TC
4.00	3.00	1760	100 LA/4	100 LA/4-184TC
7.50	5.50	1735	132 S/4	132 S/4-213TC
10.00	7.50	1735	132 M/4	132 M/4-215TC

Gearbox and Input Dimensions

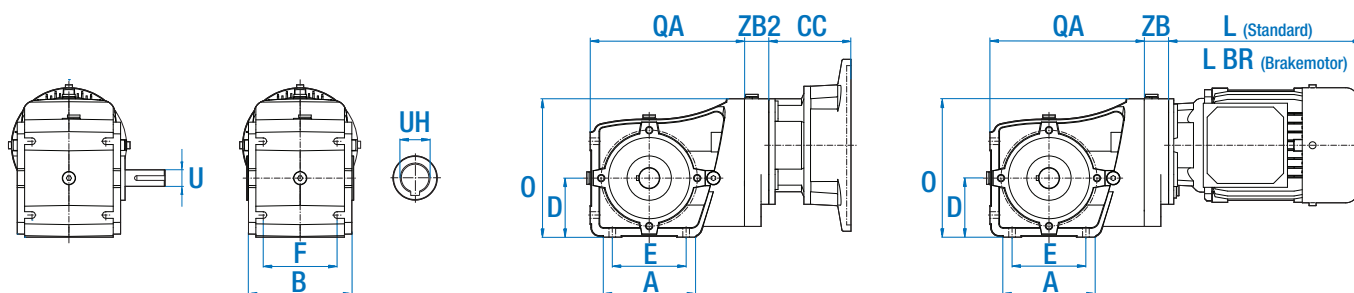

Gearbox and Shaft Dimensions

Gear Unit	A	B	D	E	F	O	QA	ZB	ZB2	U	UH
SK 920072.1	3.70	3.74	1.97	2.36	2.95	6.31	5.20	0.87	2.68	0.750	0.837
SK 92072.1	3.74	4.57	2.20	2.76	3.54	6.46	5.98	0.87	2.68	0.750	0.750
SK 92172.1	3.94	4.72	2.48	3.15	3.54	7.17	6.65	1.30	3.05	0.750	1.000
SK 92372.1	4.88	5.51	3.15	3.94	3.94	7.94	8.23	1.30	1.30	1.000	1.1875
SK 92672.1	5.91	6.38	3.94	4.72	4.72	10.03	10.20	1.37/1.61	1.37/1.61	1.250	1.375
SK 92772.1	6.93	7.32	4.41	5.51	5.51	11.27	11.57	1.59/1.82	1.59/1.82	1.375	1.500

Gear Unit	D	O	QA	ZB	ZB2	U	UH
SK 930072.1	2.07	6.41	5.30	0.87	2.68	0.750	0.837
SK 93072.1	2.32	6.66	6.10	0.87	2.68	0.750	0.750
SK 93172.1	2.56	7.24	6.73	1.30	3.05	0.750	1.000
SK 93372.1	3.31	8.10	8.39	1.30	1.30	1.000	1.1875
SK 93672.1	4.11	10.20	10.37	1.37/1.61	1.37/1.61	1.250	1.375
SK 93772.1	4.61	11.47	11.77	1.59/1.82	1.59/1.82	1.375	1.500

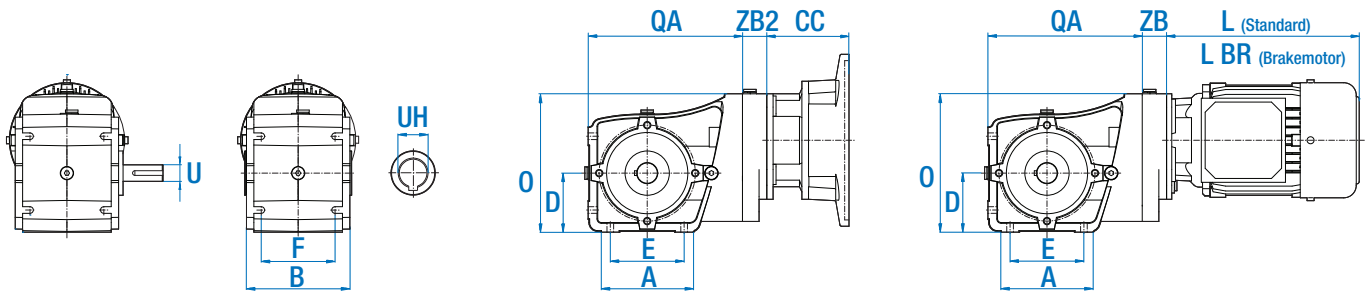

NEMA C-face Dimensions

Gear Unit	56C		140TC		180TC		210TC	
	Available	CC	Available	CC	Available	CC	Available	CC
SK 92(3)0072.1	●	1.46	●	1.93	-	-	-	-
SK 92(3)072.1	●	1.46	●	1.93	-	-	-	-
SK 92(3)172.1	●	1.46	●	1.93	-	-	-	-
SK 92(3)372.1	●	3.68	●	4.15	●	4.38	-	-
SK 92(3)672.1	●	3.68	●	4.15	●	4.38	●	4.96
SK 92(3)772.1	●	3.68	●	4.15	●	4.38	●	4.96

Integral Gear Motor Dimensions

Gear Unit	63 SP/LP		71 SP/LP		80 SP/LP		90 SP/LP		100 LP/AP	
	L	L BR	L	L BR	L	L BR	L	L BR	L	L BR
SK 92(3)0072.1	7.56	9.76	8.43	10.71	9.29	11.81	10.87	13.82	-	-
SK 92(3)072.1	7.56	9.76	8.43	10.71	9.29	11.81	10.87	13.82	-	-
SK 92(3)172.1	7.56	9.76	8.43	10.71	9.29	11.81	10.87	13.82	-	-
SK 92(3)372.1	7.56	9.92	9.29	11.57	10.28	12.80	11.89	14.84	13.07	16.65
SK 92(3)672.1	-	-	9.29	11.57	10.28	12.80	11.89	14.84	13.07	16.65
SK 92(3)772.1	-	-	9.29	11.57	10.28	12.80	11.89	14.84	13.07	16.65

Gear Unit	112 MP		132 SP/MP	
	L	L BR	L	L BR
SK 92(3)0072.1	-	-	-	-
SK 92(3)072.1	-	-	-	-
SK 92(3)172.1	-	-	-	-
SK 92(3)372.1	14.96	18.62	-	-
SK 92(3)672.1	14.96	18.62	17.13	21.34
SK 92(3)772.1	14.96	18.62	17.13	21.34

Ordering is Easy With myNORD Online Tools!

- ▶ Obtain drawing files direct from quote configuration
- ▶ Effortlessly select & configure customized drive solutions
- ▶ Create quotes with account-specific net pricing
- ▶ Order-specific documentation
- ▶ 24/7/365 order tracking
- ▶ Select and order spare parts

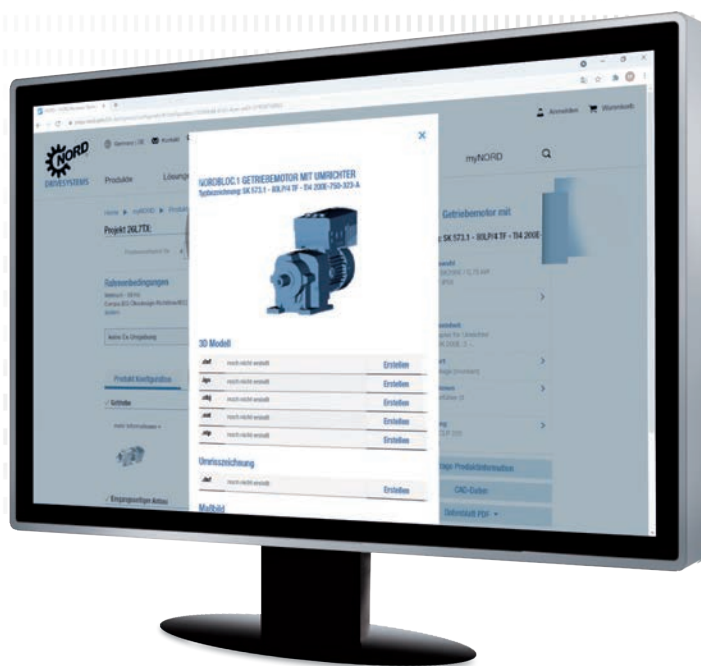

Register now at myNORD.com!

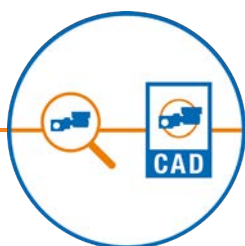

US

Central Region
Corporate Headquarters
800 NORD Drive
Waunakee, WI 53597
Tel. 888.314.6673
info.us@nord.com
www.nord.com

East Region
300E Forsyth Hall Dr.
Charlotte, NC 28273
Tel. 888.314.6673
info.us@nord.com

West Region
1180 Railroad St.
Corona, CA 92882
Tel. 888.314.6673
info.us@nord.com

South Region
350 Cypress Hill Dr, Suite 400
McKinney, TX 75071
Tel. 888.314.6673
info.us@nord.com

CA

NORD Gear Limited
Brampton, ON
41 West Drive
Brampton, ON L6T4A1
Tel. 800.668.4378
info.ca@nord.com

MX

NORD DRIVE SYSTEMS SA DE CV
Queretaro, Mexico
Av. Industria Textil B.6
Parque Industrial PYME, Huimilpan
QRO - Mexico 76950
Tel. 52 442 688 7110
info.mx@nord.com