

GETRIEBEBAU NORD

Member of the NORD DRIVESYSTEMS Group



Getriebebau NORD GmbH & Co. KG

Getriebebau-Nord-Straße 1 • 22941 Bargteheide, Germany • www.nord.com

SK CU4-ECT-C

Part number: 275 271 517

EtherCAT® – Internal Bus Interface

The bus interface may only be installed and commissioned by qualified electricians. An electrician is a person who, because of their technical training and experience, has sufficient knowledge with regard to

- Switching on, switching off, isolating, earthing and marking power circuits and devices,
- Proper maintenance and use of protective devices in accordance with defined safety standards.

DANGER

Danger of electric shock

The frequency inverter carries hazardous voltage for up to 5 minutes after being switched off.

- Work must not be carried out unless the frequency inverter has been disconnected from the voltage and at least 5 minutes has elapsed since the mains was switched off.

Validity of document

This document is only valid in conjunction with the operating instructions of the respective frequency inverter and the bus communication manual for this bus interface ( See overview at end of document). These documents contain all of the information that is required for safe commissioning of the bus interface module and the frequency inverter.

Scope of delivery

1 x	Bus interface	SK CU4-ECT-C
1 x	System bus cable set	grey/black
1 x	24 VDC cable set	brown/blue
2 x	Connecting screws	M4 x 20, cross-head



Usage area

Internal interface for connecting a decentralised frequency inverter (NORDAC *BASE*, NORDAC *FLEX*, NORDAC *LINK*) to an **EtherCAT** field bus. This is connected to the inverter via the system bus, and can directly access up to 4 frequency inverters. 2 digital inputs are available. The bus interface has a water-repellent coating. Reliable operation is retained even with condensation.

Technical Information / Datasheet	SK CU4-ECT-C			
EtherCAT Bus module	TI 275271517	V 1.5	0623	en

Technical Data

Bus interface

Temperature range	-25 °C ... xx °C *	Vibration resistance	3M7
Temperature class	Class 3K3	Protection class	IP20
		Supply voltage	24 V ± 20 %, ≈ 100 mA Reverse polarity protected

* The upper temperature limit depends on the frequency inverter and the operating mode → see "Derating"

Digital input - working range	Low: 0 V ... 5 V, High: 15 V ... 30 V
Digital input - specific data	R _i = 10 kΩ, input capacity: 10 nF, response time 1 ms, inputs as per EN 61131-2 type 1

Bus specification

EtherCAT	max. 100 MBaud	Cable	Min. Ethernet CAT-5
	electrical isolation 500 V _{eff}		Max. cable length
Bus connection	Screw terminals	Shield	Direct to PE
Bus termination	performed automatically	PE connection	via PE screw cap in terminal box
Status display	6 LEDs		
Topology	Linear bus		
Process data	8 bytes per FI + 2 bytes for IOs. Total length 2 ... 34 Bytes		

Power

Update interval of process data for 1000 devices	≈ 1 ms
Update interval for process data between bus interface and frequency inverter	≥ 5 ms
Parameter read access on the frequency inverter	≈ 12 ms
Parameter write access with storage in EEPROM	≈ 25 ms

Derating

Depending on the installation location of the bus interface (NORDAC *BASE* or NORDAC *FLEX*), the operating mode (S1, S3 ...) and the installation type of the frequency inverter (wall-mounting, motor-mounting) as well as the type of motor used, restrictions to the permissible ambient temperature must be taken into account. If the permissible ambient temperature is exceeded, the bus interface can heat up to an impermissible extent and switch itself off with an error message (E104.0).

Operating mode	Installation type	Maximum ambient temperature *	
		NORDAC <i>BASE</i>	NORDAC <i>FLEX</i>
S1	Motor	25 °C	30 °C
S3 ED 50 %, 10 min	Motor	40 °C	Not applicable
S3 ED 70 %, 10 min	Motor	Not applicable	40 °C
S1	Wall (unventilated)	37 °C	42 °C
S1	Wall (ventilated)	47 °C	48 °C

* The limits of the frequency inverter must not be exceeded (please refer to the frequency inverter manual).

Bus interface characteristics

Parametrisation	via CoE (CANopen over EtherCat)
Error Messages (Emergency Messages)	in acc. with CANopen DS-301
EtherCAT Addressing (Second Address)	DIP switch or bus interface parameters
Distributed Clocks	not supported
Access for NORD diagnosis tool via	diagnosis socket on the device (if available) and via frequency inverter

Installation

Installation location	In defined option slot inside the NORDAC device.
Fastening	with screw fastenings

- 1) With NORDAC *LINK*, this assembly must be selected when ordering. The installation is then carried out at the factory. Subsequent installation is not possible.

Installation steps

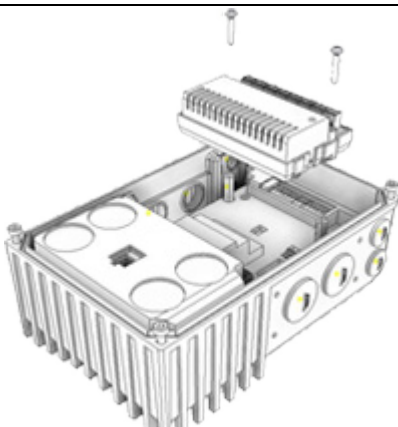
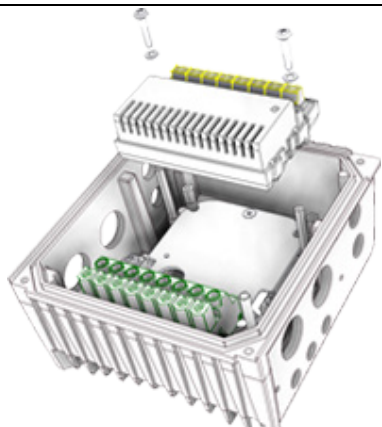
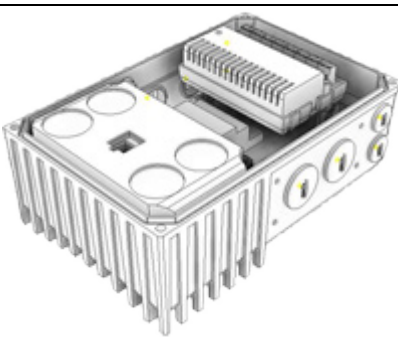
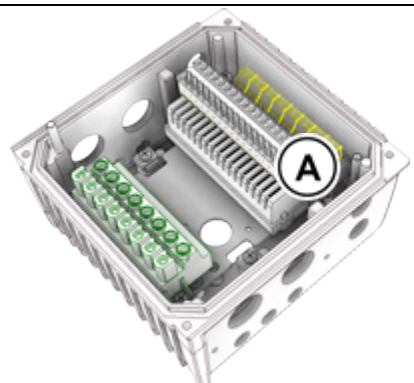
	NORDAC BASE	NORDAC FLEX *)
1.		
2.		

- *) Before carrying out installation step 1 it may be necessary to remove the control terminal bar (A), The control terminal bar (A) must be fitted after installation step 2.

Connections

Connection is established via terminal strips of the bus interface.

Potential	Contact	Name	Description		
1	Ethernet	E8	PHY1 RX-	Ethernet connection 2 Receive Data -	Out
		E7	PHY1 RX+	Ethernet connection 2 Receive Data +	
		E6	PHY1 TX-	Ethernet connection 2 Transmission Data -	
		E5	PHY1 TX+	Ethernet connection 2 Transmission Data +	
		In	E4	PHY0 RX-	Ethernet connection 1 Receive Data -
			E3	PHY0 RX+	Ethernet connection 1 Receive Data +
			E2	PHY0 TX-	Ethernet connection 1 Transmission Data -
			E1	PHY0 TX+	Ethernet connection 1 Transmission Data +
2	System bus level and digital inputs	78	SYS -	System bus data cable -	
		77	SYS +	System bus data cable +	
		C1	DIN1	Digital input 1	
		C2	DIN2	Digital input 2	
		40	GND/0V	Reference potential (0 V/GND)	
		44	24 V	Supply potential (+24 V)	
		40	GND/0V	Reference potential (0 V/GND)	
		44	24 V	Supply potential (+24 V)	

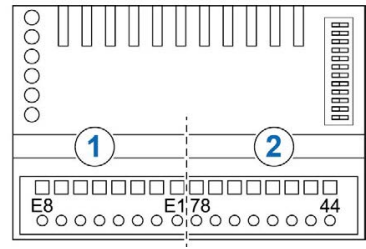

Connection examples

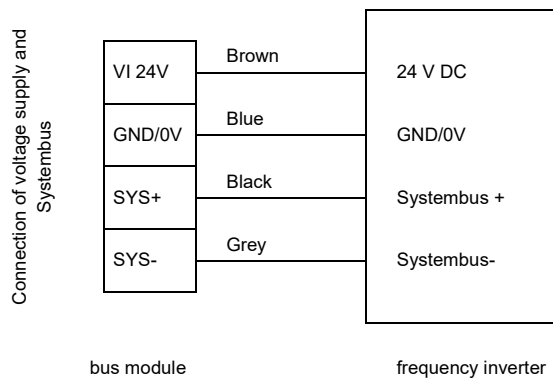

Configuration

No settings need to be made on the device. However, the bus interface can be configured with a fixed address because of the “Hot Connection Group” functionality, the so-called “Second Address”. This takes place using the DIP switches of the bus interface. The DIP switch settings are read after a "Power On" of the bus interface.

DIP switch											Meaning	
12	11	10	9	8	7	6	5	4	3	2	1	Address
X	X	0	0	0	0	0	0	0	0	0	X	0
X	X	0	0	0	0	0	0	0	0	1	X	1
X	X	0	0	0	0	0	0	0	1	0	X	2
X	X	-	-	-	-	-	-	-	-	-	X	-
X	X	1	1	1	1	1	1	1	1	1	X	511
											0	System bus terminating resistor not set.
											1	System bus terminating resistor set.
Access rights for remote maintenance												
		0										Only read access to parameters possible.
		1										Read and write access to parameters possible.
0												No control possible.
1												Control is possible.

1. System bus (DIP 1)

The system bus must be terminated at both physical ends.

2. Second Address (DIP 2...10)

The „Second Address“ can be set via this switch and controlled in parameter **P181**.

If all DIP switches 2...10 are moved to the “OFF” position, the „Second Address“ can be set via parameter **P160**.

3. Access rights for remote maintenance (DIP 11...12)

The bus interface and the connected frequency inverter can be accessed via remote maintenance using the TCP Ethernet protocol. The type of access is defined via the DIP switch with inputs 10 to 11.



Factory settings DIP switches: **OFF**

Information

NORDAC LINK

With the NORDAC LINK, the DIPP switch settings can only be adjusted at the factory. Subsequent adaptation is not possible. The configuration of the module must therefore be defined when ordering.

LED indicators

The operating statuses of the bus interface are visualised using LED indicators.

No.	Name	Colour	Meaning
1	RUN	green	Ethernet State
	ERR	red	Ethernet Error
2	DS	green	Device State
	DE	red	Device Error
3	L/A IN	green	Link/Activity IN
	L/A OUT	green	Link/Activity OUT

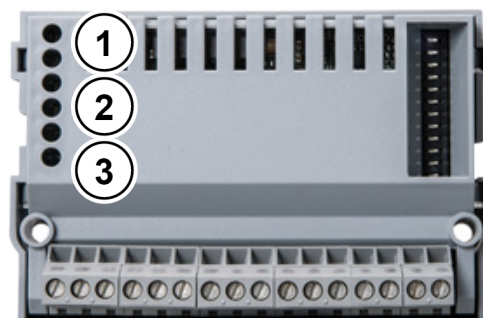

EtherCAT-specific LED

RUN	State	Meaning
OFF	Init	• No communication of process data and parameters
Flashing	Pre-Operational	• Parameter communication active • No process data communication
Single Flash	Save Operational	• Parameter communication active • Restricted process data communication • No restrictions to actual values • Setpoints not evaluated
ON	Operational	• Parameter communication active • Unrestricted process data communication

ERR	State	Meaning
OFF	No Error	• EtherCAT functioning normally on the bus interface
Flashing	Invalid Configuration	• General EtherCAT configuration error, may be generated because of an erroneous XML file
Single Flash	Unsolicited State Change	• Bus interface has changed the EtherCAT state without authorisation
Double Flash	Application Watchdog Timeout	• EtherCAT or FI timeout (P513 or P151)

L/A (Green LED)	State	Meaning
OFF	No Connection	• Bus interface not ready, no control voltage, • No bus connection (check cable connection)
Flashing	Active	• Bus interface connected and active
ON	Inactive	• Bus interface ready for operation, but no bus activity present

NORD-specific LEDs

DS (Device State)	EN (Device Error)	Meaning long flashing = 0.5 s on / 1 s off short flashing = 0.25 s on / 1 s off
OFF	OFF	Bus interface not ready, no control voltage
ON	OFF	Bus interface ready, no error, at least one frequency inverter is communicating via the system bus
ON	Short flashing	Bus interface ready, but <ul style="list-style-type: none"> • One or more of the connected frequency inverters has fault status
Long flashing	OFF	Bus interface ready and at least one other subscriber is connected to the system bus, but <ul style="list-style-type: none"> • No frequency inverter on the system bus (or connection interrupted) • One or more system bus subscriber has an address error • Software incompatible (bus interface software and FI software incompatible - update required)
Long flashing	Short flashing Flash interval 1 x - 1s pause	System bus is in status "Bus Warning" <ul style="list-style-type: none"> • Communication on system bus disrupted • No other subscribers present on system bus • Module not inserted correctly or no connection to system bus • Frequency inverter has no supply voltage
Long flashing	Short flashing Flash interval 2 x - 1s pause	System bus is in status "Bus Off" <ul style="list-style-type: none"> • The system bus 24 V power supply has been interrupted during operation
Long flashing	Short flashing Flash interval 3 x - 1s pause	System bus is in status "Bus Off" <ul style="list-style-type: none"> • The 24V voltage supply of the system bus is missing
Long flashing	Short flashing Flash interval 4 x - 1s pause	Bus interface error <ul style="list-style-type: none"> • See parameter P170
OFF	Short flashing Flash interval 1...7 - 1s pause	System error, internal program sequence interrupted <ul style="list-style-type: none"> • EMC interference (observe the wiring guidelines!) • Bus interface defective

Parameter access and diagnosis

The NORDCON software or optional control units such as the SK PAR-3H ParameterBox provide convenient access to the parameters of the bus interface and allow status information to be read out. In addition, the NORDCON *APP* – in connection with the NORDAC *ACCESS BT* Bluetooth stick – offers a practical way of mobile and wireless maintenance as well as commissioning of NORD frequency inverters.

Access is via the RJ12 diagnostics socket of the frequency inverter. The prerequisite for this is that the bus interface is connected to the frequency inverter via the system bus.

Further documentation and software (www.nord.com)

Software	Description
XML-file	Device characteristics and parameters

Software	Description
NORDCON	Parametrisation and diagnostic software

Document	Description
BU 0000	Description of NORDCON software
BU 0040	Parameter box manual
BU 0180	Frequency inverter manual NORDAC <i>BASE</i>
BU 0200	Frequency inverter manual NORDAC <i>FLEX</i>
BU 0250	Frequency inverter manual NORDAC <i>LINK</i>

Document	Description
TI 275274514	SK TIE4-M12-ETH Ethernet connection expansion entrance/exit
TI 275274505	SK TIE4-M12-SYSM System bus connection expansion exit
TI 275274506	SK TIE4-M12-SYSS System bus connection expansion entrance
BU 2300	EtherCAT bus communication manual